

157008

# SUPERIOR COURT OF ARIZONA

---

**Maricopa County Juvenile Court**

157008

1993  
Report

---

*Five Year Comparison  
1989 to 1993*

151008

**U.S. Department of Justice  
National Institute of Justice**

This document has been reproduced exactly as received from the person or organization originating it. Points of view or opinions stated in this document are those of the authors and do not necessarily represent the official position or policies of the National Institute of Justice.

Permission to reproduce this copyrighted material has been granted by

Superior Court of Arizona

to the National Criminal Justice Reference Service (NCJRS).

Further reproduction outside of the NCJRS system requires permission of the copyright owner.

NOV 2 1994

## ACQUISITIONS

**INTRODUCTION**

This report summarizes statistical information about the Maricopa County Juvenile Court Center in 1993. This report compares the court activity in 1993 with the activity of the prior four years (1989-1992).

The bulk of this report deals with juvenile delinquency and incorrigibility (status) referrals. Information is obtained from police reports, other referring entities, and from probation officers who interviewed the children and their families. It describes the number and characteristics of delinquency and incorrigible offense cases in 1993 handled by the Maricopa County Juvenile Court.

A child becomes known to the court by a "referral" which alleges that the child has violated the law in some way. It should be noted that many children whose actions or social conditions might warrant action by the Juvenile Court are not referred to the court and are therefore not included in these data. Some children are not referred simply because their illegal actions are not observed or reported, or the child is not apprehended. Furthermore, not all activities of juveniles once reported to the police are subsequently referred to the Juvenile Court. Some police agencies within the county use community counseling programs for children apprehended for minor offenses, followed by release to their parents. Consequently, the data presented in this report cannot be taken as a complete measure of the extent of delinquent behavior in Maricopa County.

When it has been decided by a referring agency that a child's action or social condition warrants intervention by the court, that child is referred, and when a child is referred, the intake division of the Juvenile Court begins the process of diagnosis and recommendation. There are numerous ways in which a referral may be dealt with by the court. However, the best interest of the child, balanced with what is in the best interest of the community, must always be considered.

Children also become known to the court when they are being adopted, when one or both parent's rights are being severed (usually prior to adoption), or when the child may have been neglected, abandoned or abused.

This report was prepared by the staff of the Division of Research and Planning of the Maricopa County Juvenile Court Center located at 3125 West Durango, Phoenix, AZ 85009. Questions may be directed to (602)506-4488.

## Workload Statistics Summary

	1989	1990	1991	1992	1993
<b><u>Juvenile Population: *</u></b>					
DES Estimate of County Population Under 18	516,616	555,791	579,382	598,618	617,823
DES Estimate of County Population 8 through 17	261,370	289,221	296,614	305,508	316,793
<b><u>Complaints Received:</u></b>					
Incorrigibility and Delinquent Complaints (Referrals) Received	26,242	29,031	28,436	27,624	33,117
Juveniles Involved	17,400	18,491	18,478	18,183	20,947
Complaints (Referrals) per Juvenile	1.51	1.57	1.54	1.52	1.58
<b><u>Detention:</u></b>					
Juveniles Brought to Detention	6,549	7,100	7,464	7,938	8,376
Juveniles Detained	4,514	5,316	6,187	6,822	7,273
Percent Detained	68.9%	74.9%	82.9%	85.9%	86.8%
Average Daily Population	149	199	240	225	281
Detention Capacity at Year End	149	213	244	244	250
Average Length of Stay in Detention (Days)	11.3	13.3	13.6	11.8	13.3
Average Daily Cost of Detention Per Juvenile	\$69.56	\$79.33	\$83.51	\$93.32	\$68.53
<b><u>Dispositions:</u></b>					
Juveniles Completing Diversion Programs	1,151	1,030	1,036	969	1,168
Juveniles Placed on Probation	1,761	2,104	3,086	2,807	3,078
Complaints Prior to Probation (Average)	1.4	1.8	1.8	1.8	1.7
Probationer's Violation Rate	.29	.32	.35	.37	.35
Probationer's Violation Rate Including Technicals	.38	.39	.43	.45	.44
Juveniles on Probation at End of Year	2,062	2,352	3,127	3,222	3,572
Juveniles Under Supervision Per Probation Officer at End of Year (Average)	47	51	54	58	65
Placements: Day & Evening Care	168	260	348	314	381
Residential	237	305	423	430	371
Juveniles Committed to Department of Youth Treatment & Rehab. (DYTR) Excluding Awards	600	618	639	668	561
Complaints Prior to Commitment (Average)	4.4	4.9	5.4	6.0	6.1
Juveniles Transferred to Adult Court **	102	101	173	231	280
Complaints Prior to Transfer (Average)	6.1	6.8	8.8	8.6	8.3

	1989	1990	1991	1992	1993
<b><u>Petitions Filed:</u></b>					
Adoption	848	803	967	913	912
Severance	605	558	557	543	541
Dependency	622	532	491	529	607
Delinquency/Incorrigibility	7,033	8,031	9,126	9,360	10,068
<b>Total Petitions Filed</b>	<b>9,108</b>	<b>9,924</b>	<b>11,141</b>	<b>11,345</b>	<b>12,128</b>

<b><u>Court Hearings Scheduled: ***</u></b>					
Adoption	1,179	1,757	1,199	1,375	1,768
Severance	1,329	1,417	1,745	1,229	1,356
Dependency	7,408	7,386	8,198	7,735	8,042
Delinquency/Incorrigibility	24,220	31,460	38,361	33,720	34,896
Miscellaneous	1,512	1,826	1,932	1,978	2,191
<b>Total Hearings Scheduled</b>	<b>35,648</b>	<b>43,846</b>	<b>51,435</b>	<b>46,037</b>	<b>48,253</b>

\*Population estimates for 1986-1989 are from Mountain West Research: June 6, 1989, distributed by ADES. 1990 is based upon the census, 1991, 1992 and 1993 are from Population Estimates of Arizona Children, Tom R. Rex, January 1994, Supreme Court of Arizona, Administrative Office of the Courts/Juvenile Justice Services Dept.

\*\*Originally 281 Juveniles were transferred to Adult Court; one case was appealed.

\*\*\*Hearing types were re-adjusted in May 1993 to re-classify the Miscellaneous category. Hearing for 1988 to 1992 were re-calculated as a result of this adjustment.

## HOW MARICOPA COUNTY'S JUVENILE JUSTICE SYSTEM WORKS

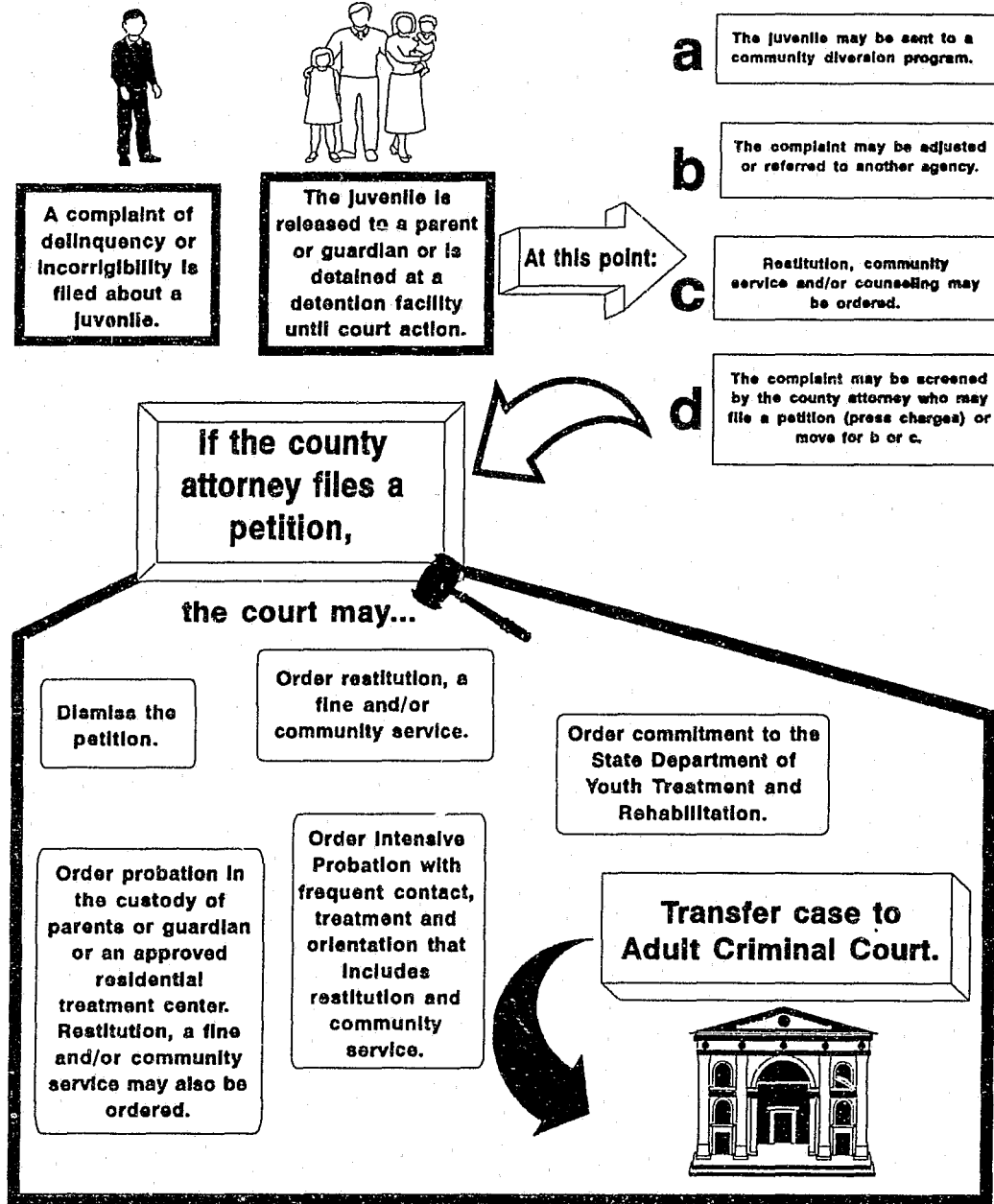

## TABLE OF CONTENTS

<b>INTRODUCTION</b> .....	<b>i</b>
<b>WORKLOAD STATISTICS SUMMARY</b> .....	<b>ii</b>
<b>HOW MARICOPA COUNTY'S JUVENILE JUSTICE SYSTEM WORKS</b> .....	<b>iv</b>
<b>TABLE OF CONTENTS</b> .....	<b>v</b>
<b>STATE AND COUNTY STATISTICS</b> .....	<b>Page 1</b>
<b>JUVENILE POPULATION OF MARICOPA COUNTY</b> .....	<b>Page 2</b>
<b>FINANCIAL AND PERSONNEL SUMMARY</b> .....	<b>Page 3</b>
<b>DELINQUENT &amp; INCORRIGIBLE REFERRALS</b> .....	<b>Page 4</b>
<b>TYPE OF JUVENILE REFERRAL</b> .....	<b>Page 5</b>
<b>20 Most Common Reasons for Referral</b> .....	<b>Page 7</b>
<b>Severity of Referral</b> .....	<b>Page 8</b>
<b>Most Severe Offense Per Referral</b> .....	<b>Page 11</b>
<b>Source of Referral</b> .....	<b>Page 20</b>
<b>Origination and Severity</b> .....	<b>Page 21</b>
<b>REFERRAL PROFILE</b>	
<b>Sex of Referred</b> .....	<b>Page 23</b>
<b>Age at Referral</b> .....	<b>Page 24</b>
<b>Ethnicity of Referred</b> .....	<b>Page 26</b>
<b>School Status of Referred</b> .....	<b>Page 27</b>
<b>School Grade of Referred</b> .....	<b>Page 29</b>
<b>School Districts by Severity</b> .....	<b>Page 30</b>
<b>Number of Previous Referrals</b> .....	<b>Page 34</b>
<b>FIRST OFFENDER</b>	
<b>Severity of Referral</b> .....	<b>Page 37</b>
<b>Sex of Referred</b> .....	<b>Page 38</b>
<b>Ethnicity of Referred</b> .....	<b>Page 38</b>
<b>Age at Referral</b> .....	<b>Page 39</b>
<b>School Grade of Referred</b> .....	<b>Page 40</b>
<b>DETENTION</b>	
<b>Intake Screening</b> .....	<b>Page 41</b>
<b>Average Daily Population</b> .....	<b>Page 42</b>
<b>Length of Stay</b> .....	<b>Page 42</b>
<b>Daily Cost per Juvenile</b> .....	<b>Page 42</b>

Severity of Referred .....	Page 43
Sex of Referred .....	Page 43
Ethnicity of Referred .....	Page 43
Age at Referral .....	Page 44
Number of Previous Referrals .....	Page 44
Source of Referral .....	Page 45
<b>FIELD PROBATION .....</b>	<b>Page 46</b>
Probation/Placement Assessments and Collections .....	Page 47
<b>COMMITMENTS .....</b>	<b>Page 48</b>
<b>TRANSFERS (REMANDS) .....</b>	<b>Page 49</b>
<b>PROBATION, COMMITMENT, TRANSFER</b>	
Severity of Referral .....	Page 50
Sex of Referred .....	Page 50
Ethnicity of Referred .....	Page 50
Age at Referral .....	Page 51
Previous Legal Status of Referred .....	Page 51
<b>INTAKE</b>	
Caseload .....	Page 52
New Complaints Received .....	Page 53
PIC-ACT .....	Page 54
<b>HOME DETENTION .....</b>	<b>Page 55</b>
<b>PLACEMENTS .....</b>	<b>Page 56</b>
<b>DIVERSION PROGRAMS .....</b>	<b>Page 57</b>
<b>RECIDIVISM .....</b>	<b>Page 58</b>
<b>PETITIONS FILED .....</b>	<b>Page 59</b>
<b>COURT HEARINGS SUMMARY .....</b>	<b>Page 60</b>
<b>DISPOSITION OF REFERRALS</b>	
Non-Court Dispositions .....	Page 62
Traffic Court Dispositions .....	Page 63
Court Dispositions .....	Page 63
<b>Appendix A      Zipcode of Residence at Time of Referral .....</b>	<b>Page 64</b>
<b>Appendix B      Actual Schools in each School District .....</b>	<b>Page 71</b>



# MARICOPA COUNTY JUVENILE COURT CENTER

## STATE AND COUNTY STATISTICS

Arizona is geographically the sixth largest state in the nation with 113,642 square miles and a population estimate in 1993 of 3,958,875 in 15 counties. Maricopa County is the seventh most populated county in the nation with 9,204 square miles and a population of 2,291,200. (Department of Economic Security Population Estimates for 1993.)

Approximately 57.9% of the state's population resides in Maricopa County. There are 249 residents per square mile. Nationwide, Maricopa County has the seventh largest population. Phoenix is the county seat.

### ARIZONA

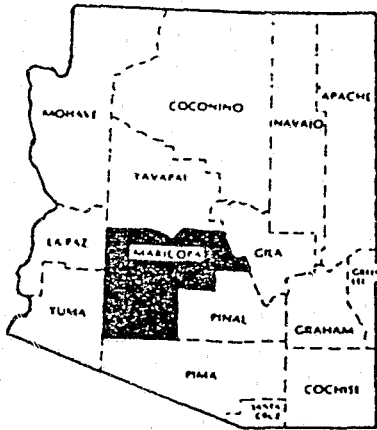

### MARICOPA COUNTY

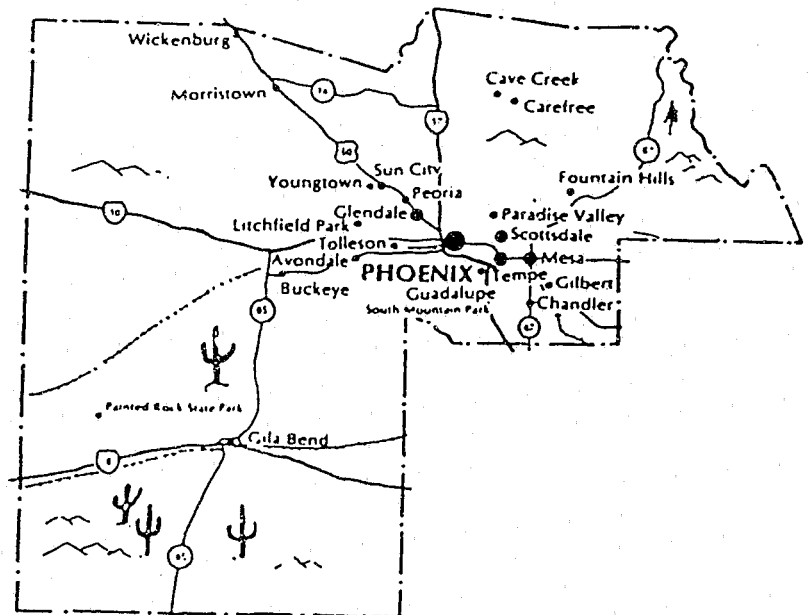

# Juvenile Population In Maricopa County

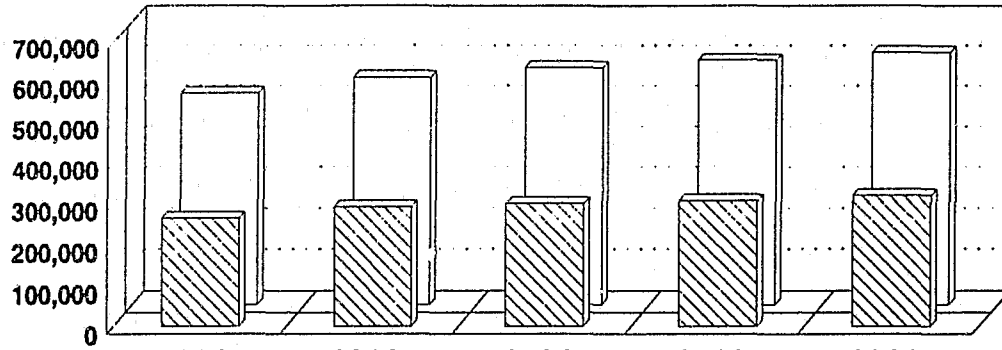

	1989	1990	1991	1992	1993
Total	516,616	555,791	579,382	598,618	617,823
Ages 8 to 17	261,370	289,221	296,614	305,508	316,793
Ages 0 to 7	255,246	266,570	282,768	293,110	301,030

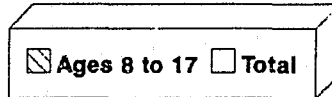

Source: Department of Economic Security (1989-1990)  
 Supreme Court of Arizona, Administrative Office of the  
 Courts, Population Estimates of Arizona Children (1991-1993)

Over 600,000 children live in Maricopa County, and of those, 315,550 are between 8 and 17 years of age inclusively who fall under the the jurisdiction of the juvenile court.

Juveniles between the ages of 8 and 17 are at risk of referral to the Juvenile Court for delinquency or incorrigibility (status) offenses.

# MARICOPA COUNTY JUVENILE COURT CENTER

## Financial Summary

Fiscal	1989-1990	1990-1991	1991-1992	1992-1993	1993-1994
<b>Operating Budget:</b>	<b>15,876,706</b>	<b>21,972,094</b>	<b>23,589,504</b>	<b>20,529,115</b>	<b>19,972,402</b>
<b>State Grants:</b>					
Foster Care	6,380,416	8,322,541	10,591,936	8,376,351	8,487,009
Family Counseling	145,124	174,888	194,572	252,336	156,670
State Aid to Probation	294,492	350,655	352,155	325,258	354,029
PIC-ACT	493,733	451,570	295,498	600,494	582,331
Judge Pro-Tempore	198,835	—	—	—	—
JIPS	1,031,811	1,068,678	1,154,867	1,355,781	1,296,245
CASA	50,330	53,823	74,306	91,398	91,398
<b>Federal Grants:</b>					
Food and Nutrition	161,451	210,938	234,423	230,000	248,021
<b>Juvenile Probation Service Fees:</b>					
Training Unit	51,740	6,070	152,372	30,000	0
Field Supervisors	106,915	113,453	112,602	161,722	114,230
Field Probation Officers	—	12,061	104,740	67,486	114,922
Financial Accountability	57,755	61,712	50,997	66,049	21,414
<b>TOTAL FUNDS</b>	<b>24,847,308</b>	<b>32,798,283</b>	<b>36,907,992</b>	<b>32,085,990</b>	<b>31,438,671</b>

## Personnel Summary

Personnel	1993	TOTAL
<b>Court</b>	Judges	6
	Commissioners	11
	Support Staff	23
		<b>40</b>
<b>Probation Officers</b>	Budgeted	2
	Grants	278
		<b>280</b>
<b>Child Care Staff</b>	Budgeted	0
	Grants	64
		<b>64</b>
<b>Administrative Support Staff</b>	Budgeted	80
	Grants	14
		<b>94</b>
<b>On-Call Staff</b>	Child Care Staff	118
	Administrative Staff	8
		<b>126</b>
<b>PERSONNEL TOTAL</b>		<b>604</b>

# Delinquent & Incurrigible Referrals

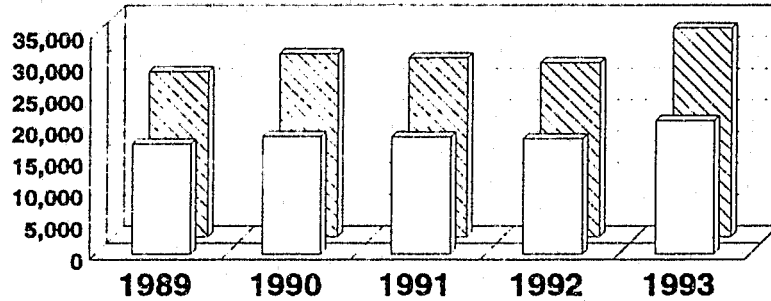

Referrals Received	26,236	29,022	28,426	27,624	33,117
# Juveniles Involved	17,400	18,491	18,478	18,183	20,947
Referrals/Juvenile	1.51	1.57	1.54	1.52	1.58
Population Referred	6.7%	6.4%	6.2%	5.9%	6.6%

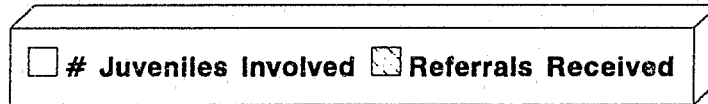

In any given year, about 6% of the juvenile population (between the ages of 8 and 17) of Maricopa County is referred at least once to the Court Center. That's about one juvenile in every 15 at risk.

In 1993, there were 33,117 referrals generated by 20,947 juveniles.

This is an increase of 20.4% from 1989 in the number of juveniles referred to the court, and a 26.2% increase in the number of referrals.

Referrals in 1993 show an increase of 20% over last year (1992) which can be attributed to a 152% increase in the number of curfew violations.

# Type of Referral

## Delinquent & Incurrigible

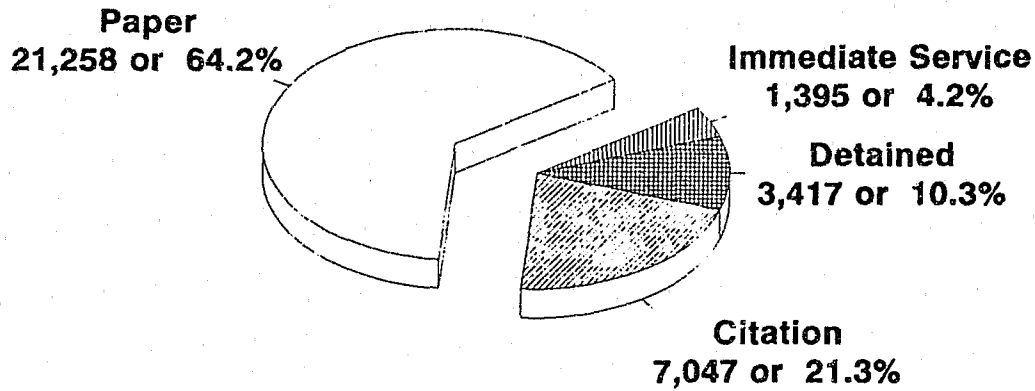

**33,117 Total Referrals for 1993**

There are four types of referrals: Detained; child is detained at detention center. Immediate Service; child is brought to detention center, screened and released for follow-up. Paper; report is sent to court for processing. Citation; child is issued a citation (ticket).

Type of Referral 1992	Violent	Grand Theft	Obstruct	Fight	Drugs	Peace	Theft	Status	Hold	TOTAL
Detained	760	1,020	91	365	332	290	235	302	22	3,417
Immed.Srv	27	147	18	272	56	207	160	503	5	1,395
Paper	1,207	3,802	1,919	1,729	1,363	2,560	5,960	2,615	103	21,258
Citation	0	0	0	0	0	1	0	7,046	0	7,047
<b>TOTAL</b>	<b>1,994</b>	<b>4,969</b>	<b>2,028</b>	<b>2,366</b>	<b>1,751</b>	<b>3,058</b>	<b>6,355</b>	<b>10,466</b>	<b>130</b>	<b>33,117</b>

Type of Referral	1989	1990	1991	1992	1993
Detained	3,060	3,931	3,426	3,231	3,417
Immediate Service	1,727	1,583	1,125	853	1,395
Paper Referral	18,233	19,527	20,296	19,976	21,258
Citation	3,216	3,981	3,579	3,564	7,047
<b>TOTAL</b>	<b>26,236</b>	<b>29,022</b>	<b>28,426</b>	<b>27,624</b>	<b>33,117</b>

## Most Common Reason for Referral in 1993

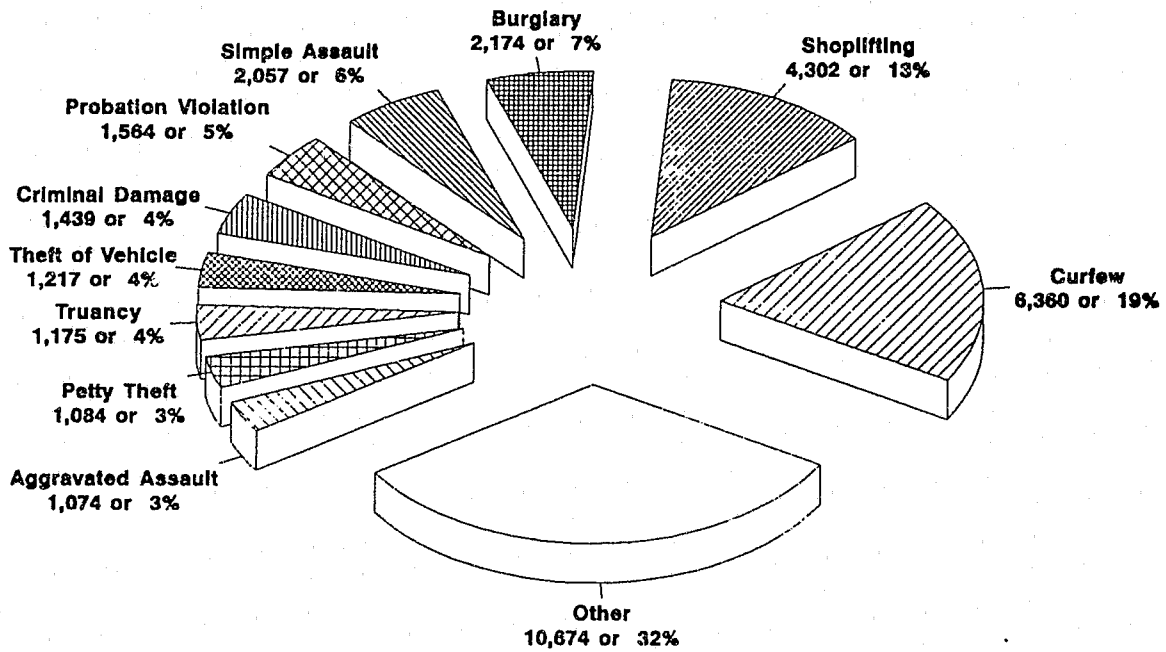

# MARICOPA COUNTY JUVENILE COURT CENTER

## Most Common Reasons for Referral

1993 Rank	Offense	1989	1990	1991	1992	1992 Rank	1993	% of 1993	Change In Last 5 Years
1	Curfew	2,104	2,673	2,329	2,520	2	6,360	19.2	+202%
2	Shoplifting	4,289	4,220	4,187	3,957	1	4,302	13.0	0
3	Burglary *	2,602	2,669	2,669	2,327	3	2,174	6.6	-16%
4	Assault-Simple	1,235	1,484	1,514	1,642	4	2,057	6.2	+67%
5	Probation Violation	906	749	1,187	1,251	7	1,564	4.7	+73%
6	Crim. Damage *	1,011	1,129	1,366	1,301	6	1,439	4.3	+42%
7	Theft of Vehicle	1,477	1,817	1,717	1,494	5	1,217	3.7	-18%
8	Truancy	739	1,022	957	870	12	1,175	3.5	+59%
9	Petty Theft	1,141	1,404	1,270	1,189	9	1,084	3.3	-5%
10	Aggravated Assault	610	890	964	1,005	11	1,074	3.2	+76%
11	Runaway-In County	710	646	599	616	15	993	3.0	+40%
12	Liquor-Possess	1,372	1,538	1,499	1,215	8	992	3.0	-28%
13	Trespass *	1,005	1,263	1,130	1,046	10	973	2.9	-3%
14	Marijuana *	508	408	465	636	14	952	2.9	+87%
15	Disorderly Conduct	521	578	644	664	13	826	2.5	+59%
16	Incorrigible	189	192	261	307		705	2.1	+273%
17	Weapons *	165	306	307	415	18	491	1.5	+198%
18	Robbery *	275	327	374	337		383	1.2	+39%
19	Theft *	787	499	509	459	17	358	1.1	-55%
20	Intimidation	149	182	207	251		309	0.9	+107%
<b>Sub Total</b>		<b>21,795</b>	<b>23,976</b>	<b>24,155</b>	<b>23,502</b>		<b>29,428</b>	<b>88.9</b>	<b>+35%</b>
<b>All Other Offenses</b>		<b>5,179</b>	<b>5,841</b>	<b>5,031</b>	<b>4,746</b>		<b>3,689</b>	<b>11.1</b>	<b>-29%</b>
<b>TOTAL REFERRALS</b>		<b>26,974</b>	<b>29,817</b>	<b>29,186</b>	<b>28,248</b>		<b>33,117</b>	<b>100.0</b>	<b>+23%</b>

\*Indicates combined or generic allegations

# Severity of Referral

## Delinquent & Incurrigible

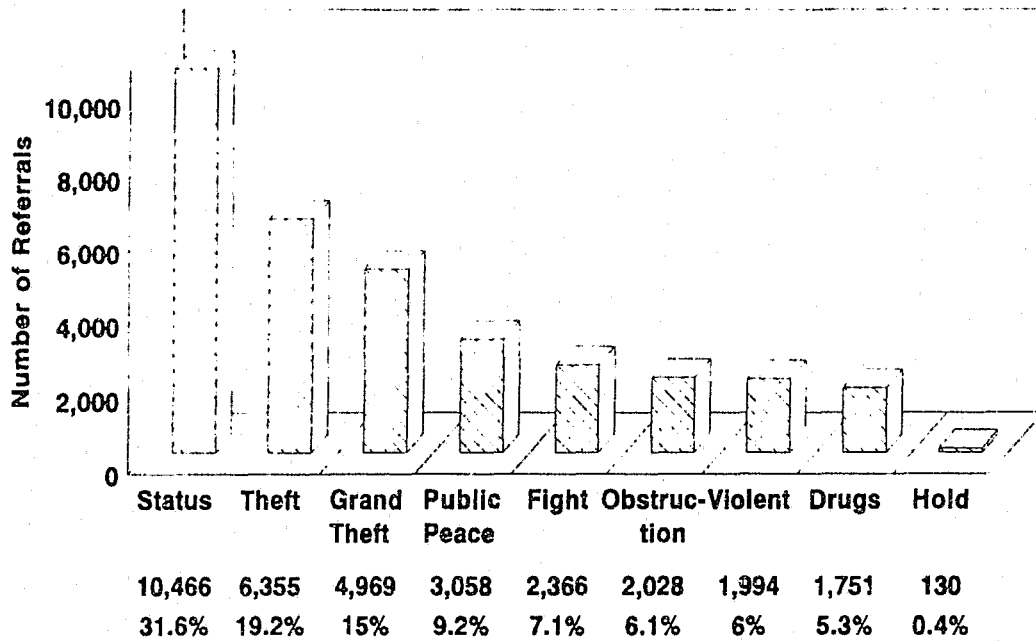

**Number of Delinquent & Incurrigible Referrals**  
**Percentage Based on 33,117 Total Referrals for 1993**

Referrals are categorized as to their severity according to the offense. This order was established by the Maricopa County Juvenile Court Center and is unique to this Court Center. Property crimes (Felony/Grand Theft and Misdemeanor/Theft) account for 34.2% of all referrals.

Incurrigible (status) offenses were 31.6%, Public Order (Peace and Obstructing) 15.4%, Person crimes (Felony/Violent and Misdemeanor/Fight) 13.2%, Drug law violations (Felony and Misdemeanor) were 5.3%, and Administrative (Hold) were 0.4% of 31,117 total referrals for 1993.



MARICOPA COUNTY JUVENILE COURT CENTER

SEVERITY OF REFERRAL 1989-1993

**Violent Referrals**

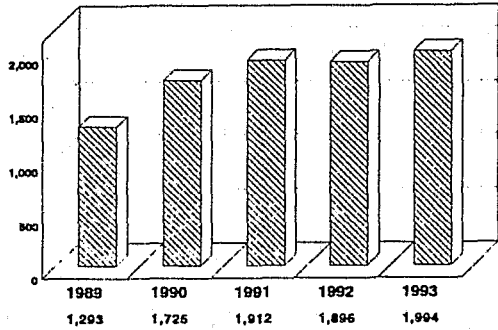

**Fight Referrals**

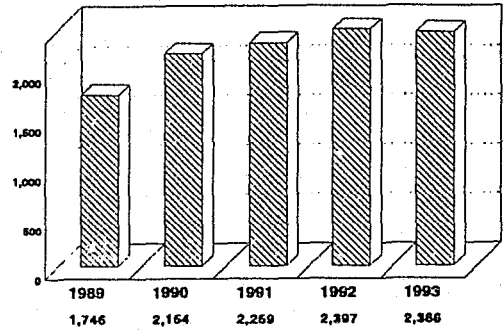

**Grand Theft Referrals**

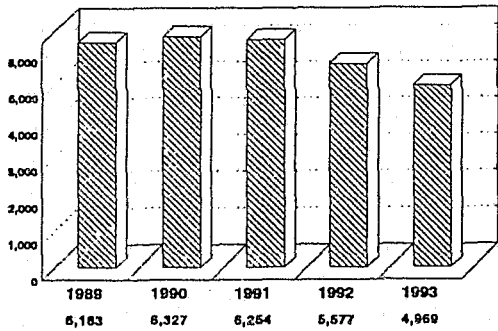

**Drug Referrals**

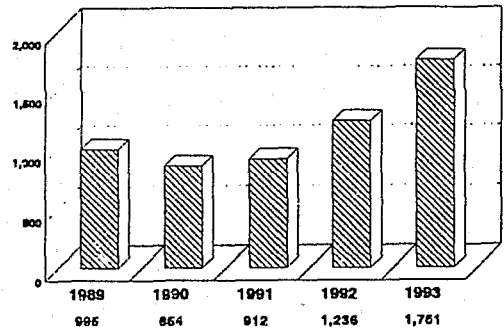

**Obstruction Referrals**

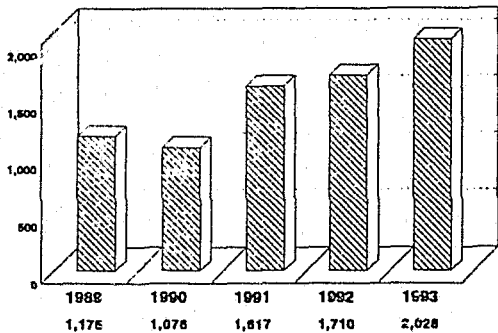

**Public Peace Referrals**

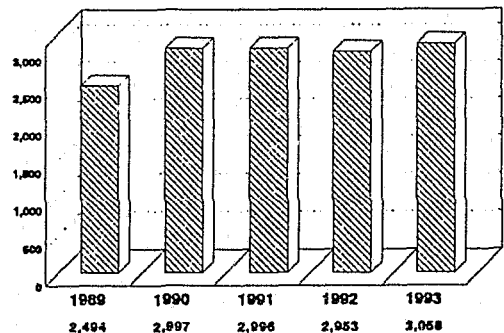

# MARICOPA COUNTY JUVENILE COURT CENTER

## Petty Theft Referrals

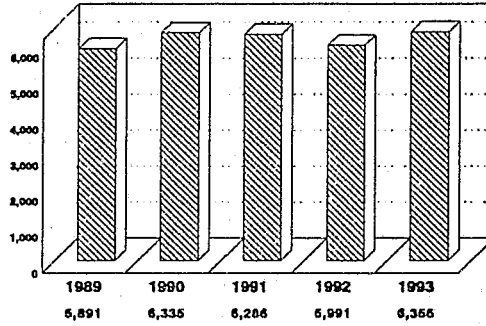

## Status Referrals

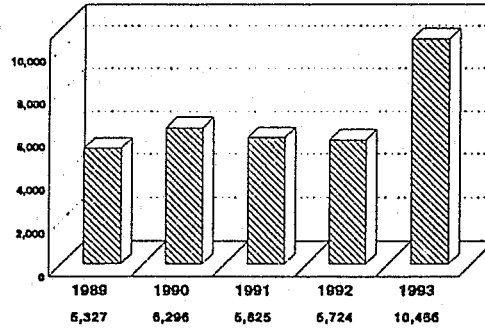

## Hold/Administrative Referrals

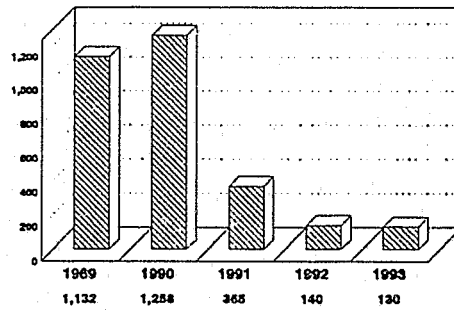

MARICOPA COUNTY JUVENILE COURT CENTER

Most Severe Offense Per Referral

	Offense	1989	1990	1991	1992	1993
<b>VIOLENT Felony Against Person</b>	Aggravated Assault	610	890	964	1,005	1,074
	Aggravated Robbery	129	117	127	126	163
	Arson-Occupied	41	49	30	34	39
	Assault-Strong Arm	1	0	0	0	0
	Attempted Murder	4	9	11	9	12
	Assault-Aggravated Deadly Weapon	0	0	6	0	20
	Child Molest	81	99	121	130	95
	Child Abuse	4	7	7	5	0
	Custodial Interference	3	2	1	6	5
	Endangerment	107	147	197	180	140
	Homicide (not specified)	0	0	2	0	4
	Kidnap	25	21	32	19	17
	Leaving Accident-Death or Injury	16	22	25	16	14
	Manslaughter	7	3	7	1	7
	Murder 1	9	11	12	12	31
	Murder 2	4	10	8	13	10
	Negligent Homicide	2	1	2	4	2
	Purse Snatching-Forcible	1	0	0	0	0
	Robbery-Strong Arm	48	57	68	63	47
	Robbery-Weapon	98	153	179	148	173
	Set Explosives	6	2	12	6	4
	Sexual Abuse	40	38	33	41	52
	Sexual Assault	31	53	39	51	31
	Sex with Minor	20	27	23	17	35
	Sodomy with Minor	0	0	1	0	0
	Threatening Intimidation- Gang	0	0	0	0	13
	Unlawful Imprisonment	6	7	5	10	6
<b>VIOLENT TOTAL</b>		<b>1,293</b>	<b>1,725</b>	<b>1,912</b>	<b>1,896</b>	<b>1,994</b>

**MARICOPA COUNTY JUVENILE COURT CENTER**

	<b>Offense</b>	<b>1989</b>	<b>1990</b>	<b>1991</b>	<b>1992</b>	<b>1993</b>
<b>GRAND THEFT</b>  <b>Felony</b>  <b>Against</b>  <b>Property</b>	Arson-Unoccupied	26	48	41	43	38
	Burglary from Auto	5	1	0	0	0
	Burglary Tools-Possess	28	22	35	22	14
	Burglary 1 (Armed)	124	83	103	92	76
	Burglary 2 (Residence)	973	977	1,043	915	818
	Burglary 3 (Commercial)	1,505	1,609	1,539	1,320	1,280
	Criminal Damage (Aggravated) 100 - 10,000	0	0	0	3	32
	Criminal Damage 100+	423	356	451	378	394
	Criminal Damage 1,500+	39	52	71	75	71
	Criminal Damage 10,000+	7	15	16	10	6
	Criminal Damage 250+ (\$250-\$1,999)	79	0	0	0	0
	Criminal Damage 2000+ (\$2,000-\$9,999)	10	0	0	0	0
	Criminal Syndicate-Assisting	0	0	0	1	6
	Criminal Syndicate-Participation	0	0	0	18	1
	Embezzlement	0	1	0	0	1
	Extortion	8	10	2	6	8
	Failure to Return Rental Property	0	0	0	0	1
	Forgery of Checks	65	77	107	118	125
	Forgery-Counterfeiting	4	2	4	3	0
	Forgery-Credit Cards	0	0	0	0	2
	Fraud	4	1	4	1	1
	Fraud Use of Credit Cards	9	13	13	22	17
	Fraudulent Schemes	16	21	24	11	14
Illegally Conducting an Enterprise	0	0	0	3	0	
Joyride	299	263	210	168	205	
Money Laundering	0	0	0	1	0	

**MARICOPA COUNTY JUVENILE COURT CENTER**

	<b>Offense</b>	<b>1989</b>	<b>1990</b>	<b>1991</b>	<b>1992</b>	<b>1993</b>
<b>GRAND THEFT</b>	Purse Snatching	1	0	0	0	0
<b>(continued)</b>	Shoplift \$100+ (Felony)	79	244	130	83	49
<b>Felony</b>	Stolen Property-Possess	3	4	6	46	55
<b>Against</b>	Stolen Property 1	70	89	107	127	37
<b>Property</b>	Stolen Property 2	53	40	29	47	36
	Stolen Vehicle	1	1	1	0	1
	Stolen Vehicle-Possession	0	1	0	0	0
	Theft 250 (100-250)	267	1	0	1	0
	Theft 500 (250-500)	181	1	1	0	0
	Theft 1000 (500-1000)	85	0	0	0	0
	Theft 1000+ (1000 or more)	109	0	1	0	0
	Theft \$250+ (\$250-\$499)	65	230	234	206	150
	Theft \$500+ (\$500-\$749)	26	69	72	61	52
	Theft \$750+ (\$750-\$1,499)	14	51	66	59	58
	Theft \$1,500+ (\$1,500 or more)	40	147	135	132	98
	Theft of Credit Card	19	30	37	44	31
	Theft of Firearm	37	31	44	53	53
	Theft of Mail	20	14	10	13	17
	Theft from Person	12	6	1	1	5
	Theft of Vehicle	1,477	1,817	1,717	1,494	1,217
<b>GRAND THEFT TOTAL</b>		<b>6,183</b>	<b>6,327</b>	<b>6,254</b>	<b>5,577</b>	<b>4,969</b>

**MARICOPA COUNTY JUVENILE COURT CENTER**

	<b>Offense</b>	<b>1989</b>	<b>1990</b>	<b>1991</b>	<b>1992</b>	<b>1993</b>
<b>OBSTRUCTION</b>	Contempt of Court	100	103	236	257	211
	Escape 1 (1st Degree)	0	2	2	0	0
	Escape 2 (2nd Degree)	12	8	15	16	10
	Escape 3 (3rd Degree)	14	18	16	13	25
	Failure to Appear (1st Degree)	0	0	0	1	0
	Hindering Prosecution 1st Degree	10	11	18	25	19
	Impersonating a Public Servant	0	0	0	0	1
	Influencing a Witness	1	10	10	4	1
	Obstructing Government Operations	0	0	0	4	21
	Obstructing Judiciary	1	0	0	1	0
	Obstructing Police	15	20	18	16	11
	Obstructing Criminal Investigation	10	16	20	22	24
	Obstructing-Wearing Mask	1	0	1	0	0
	Parole Violation	5	7	4	1	5
	Perjury	0	2	0	0	0
	Probation Violation	906	749	1,187	1,251	1,564
	Resisting Arrest	100	130	88	99	90
	Tampering with Physical Evidence	0	0	2	0	0
	Tampering with a Witness	0	0	0	0	1
Unlawful Flight	0	0	0	0	45	
<b>OBSTRUCTION TOTAL</b>		<b>1,175</b>	<b>1,076</b>	<b>1,617</b>	<b>1,710</b>	<b>2,028</b>

	<b>Offense</b>	<b>1989</b>	<b>1990</b>	<b>1991</b>	<b>1992</b>	<b>1993</b>
<b>FIGHT</b>	Assault-Simple	1,235	1,464	1,514	1,642	2,057
<b>Misdemeanor</b>	Domestic Violence	362	508	538	504	0
<b>Against Person</b>	Intimidation	149	182	207	251	309
<b>- FIGHT TOTAL</b>		<b>1,746</b>	<b>2,154</b>	<b>2,259</b>	<b>2,397</b>	<b>2,366</b>

**MARICOPA COUNTY JUVENILE COURT CENTER**

	<b>Offense</b>	<b>1989</b>	<b>1990</b>	<b>1991</b>	<b>1992</b>	<b>1993</b>
<b>DRUGS</b>	Controlled Substances- Manufacture Imitation	0	0	0	0	1
	Controlled Substances- Possess Imitation	0	0	0	0	4
	Dangerous Drugs- Narcotics	0	0	1	0	0
	Dangerous Drugs-Possess or Use	0	0	0	0	59
	Dangerous Drugs-Possess for Sale	0	0	0	0	9
	Dangerous Drugs-Sale	0	0	0	0	4
	Drugs Paraphernalia	144	136	96	93	215
	Involving a Minor in Drug Offenses	0	0	0	0	1
	Hallucinogen-Possess and Manufacture	1	1	2	0	2
	Marijuana-Grow	1	0	1	2	1
	Marijuana-Possess	465	369	422	510	693
	Marijuana-School	0	0	0	61	189
	Marijuana-Sell	42	37	42	61	58
	Marijuana-Traffic	0	2	0	2	11
	Narcotic Drugs- Manufacture	1	1	1	0	0
	Narcotic Drugs-Other	2	1	3	4	0
	Narcotic Drugs-Possess	160	117	110	115	113
	Narcotic Drugs-School	0	0	0	11	13
	Narcotic Drugs-Sell	143	131	104	91	74
	Narcotic Drugs-Transport	0	0	0	4	0
	Peyote-Possession and Sale	0	0	0	0	1
	Sniffing-Gasoline	0	2	3	0	1
	Sniffing-Glue	0	1	1	5	6
Sniffing-Other Toxic Substances	15	13	34	49	37	
Sniffing-Paint	21	43	92	228	259	
<b>DRUGS TOTAL</b>		<b>995</b>	<b>854</b>	<b>912</b>	<b>1,236</b>	<b>1,751</b>

## MARICOPA COUNTY JUVENILE COURT CENTER

	Offense	1989	1990	1991	1992	1993
<b>PUBLIC PEACE</b>	Abuse of Teacher or School Employee	0	0	0	0	4
<b>Miscellaneous</b>	Boating Offenses-General	1	0	0	0	0
	CCW-Carrying a Concealed Weapon	0	1	1	0	5
	Child Neglect	0	0	0	0	4
	Conservation	13	7	23	22	1
	Contributing to Delinquency of Minor	8	6	3	7	5
	Cruelty to Animals	10	15	5	11	8
	Disorderly Conduct	521	578	644	664	827
	Disturbing the Peace	2	5	1	1	0
	Driving Under the Influence-Drugs	0	0	1	1	0
	Driving Under the Influence-Liquor (DWI)	16	14	15	15	16
	Enticement for Prostitution	0	0	1	1	0
	Escape-General	0	0	1	0	0
	Escape Institution	2	0	0	7	1
	Explosives-Misconduct	2	0	0	1	2
	Failure to Procure Business License	0	0	0	0	1
	False Report	268	322	325	322	307
	False or Forged Message	0	0	0	0	3
	Fireworks-Use Illegally	22	11	21	14	17
	Flight to Avoid	4	1	2	16	9
	Flight to Escape	0	0	1	0	0
	Gambling/Gaming-General	0	0	1	0	0
	Game and Fish-General	1	0	1	3	3
	Gun to Minor-Sale or Gift of Firearm	0	1	0	1	0
	Harassment-Telephone	0	0	0	0	14
	Hindering Prosecution 2nd Degree	8	6	17	9	9
	Indecent Exposure	61	45	55	44	47



**MARICOPA COUNTY JUVENILE COURT CENTER**

	<b>Offense</b>	<b>1989</b>	<b>1990</b>	<b>1991</b>	<b>1992</b>	<b>1993</b>
<b>PUBLIC PEACE</b>	Interference-Judicial Proceedings	79	110	145	89	53
<b>(continued)</b>	Leaving Scene of Accident	0	0	0	0	2
<b>Miscellaneous</b>	Lewd and Lascivious Acts	0	0	0	1	0
	Liquor-General	1	0	0	0	0
	Loitering-Drugs	5	0	0	0	0
	Loitering	59	42	52	55	36
	Minor in Poss. of Firearm	0	0	0	0	32
	Nuisance	3	6	10	3	4
	Obstructing-Highway	0	0	0	1	3
	Phone-Unlawful Use	60	66	48	40	51
	Poss. of Defaced Weapon	0	0	0	0	9
	Procuring for Prostitution	0	1	0	0	1
	Prostitution	38	30	26	12	6
	Public Peace	4	0	0	3	2
	Reckless Burning	41	64	50	35	56
	Reckless Driving-Non Intoxicants	2	3	2	5	1
	Riot	0	0	4	1	13
	School Interference	66	64	83	90	86
	Sexual Indecency	14	7	7	12	6
	Traffic Offense-Moving	9	16	9	11	9
	Traffic Off. Non-Moving	4	4	8	3	2
	Traffic Offense-Other	0	0	0	1	0
	Trespass-Other	0	1	0	0	0
	Trespass-Residential	238	246	260	231	192
	Trespass-Yard	125	150	132	114	119
	Trespass 2nd Degree	290	472	370	322	324
	Trespass 3rd Degree	352	394	365	379	338
	Unlawful Assembly	0	1	0	0	0
	Vandalism of Venerated Objects	0	0	0	0	1
	Vulgar Obscene Language	0	2	0	1	4
	Weapons Misconduct	149	266	279	376	377
	Weapons-Fire	14	35	18	20	19
	Weapons-Other	2	5	10	8	3
	Weapons-School	0	0	0	1	26
<b>PUBLIC PEACE TOTAL</b>		<b>2,494</b>	<b>2,997</b>	<b>2,996</b>	<b>2,953</b>	<b>3,058</b>

**MARICOPA COUNTY JUVENILE COURT CENTER**

	<b>Offense</b>	<b>1989</b>	<b>1990</b>	<b>1991</b>	<b>1992</b>	<b>1993</b>
<b>THEFT</b>	Aggravated Criminal Damage-Petty	0	0	0	4	6
<b>Misdemeanor</b>	Bribery	1	0	1	0	0
<b>Property</b>	Criminal Damage-Petty	453	706	828	831	930
	Failure to Return Rental Property	0	0	0	1	3
	Issue of Bad Check	0	1	0	0	0
	Malicious Mischief	3	0	0	0	0
	Malicious Mischief- Property	2	0	0	0	0
	Petty Theft	1,141	1,404	1,270	1,189	1,084
	Polluting	0	0	0	2	6
	Possession of Stolen Property-Petty	0	0	0	5	24
	Shoplifting	4,289	4,220	4,187	3,957	4,302
	Theft-Bike	0	3	0	1	0
	Theft-Building	0	0	0	1	0
	Theft-Coin Operated Machine	0	1	0	0	0
	Theft-General	2	0	0	0	0
<b>THEFT TOTAL</b>		<b>5,891</b>	<b>6,335</b>	<b>6,286</b>	<b>5,991</b>	<b>6,355</b>

## MARICOPA COUNTY JUVENILE COURT CENTER

	Offense	1989	1990	1991	1992	1993
<b>STATUS</b>	Curfew	2,104	2,673	2,329	2,520	6,360
	Incorrigible-Refuse to Obey Parents	189	192	261	307	705
	Incorrigible-General	1	0	0	0	0
	Liquor-Misrepresent Age in Purchase	3	1	1	5	3
	Liquor-Possess Unlawfully	1,372	1,538	1,499	1,215	992
	Possession of Weapon	0	0	0	10	25
	Runaway-In County	701	646	599	616	993
	Runaway-FOJ (From Other Jurisdiction)	217	218	169	145	183
	Tobacco-Possess or Use	1	6	10	36	30
	Truancy-Habitually from School	739	1,022	957	870	1,175
<b>STATUS TOTAL</b>		<b>5,327</b>	<b>6,296</b>	<b>5,825</b>	<b>5,724</b>	<b>10,466</b>

	Offense	1989	1990	1991	1992	1993
<b>HOLD</b>	Court Order Hold	1	1	0	0	0
	Courtesy Hold	5	2	2	6	3
	Courtesy Supervision	46	2	8	5	7
	For Hearing-Other Court	32	47	65	69	62
	Other Court Supervision-Transferred	0	40	44	45	0
	Transfer Probation Supervision to Another Court	0	0	0	0	36
	Traffic Warrant	123	196	30	1	0
	Warrant	880	927	175	1	1
	Warrant FOJ (From Other Jurisdiction)	45	43	41	13	21
<b>HOLD TOTAL</b>		<b>1,132</b>	<b>1,258</b>	<b>365</b>	<b>140</b>	<b>130</b>

<b>GRAND TOTAL</b>		<b>26,236</b>	<b>29,022</b>	<b>28,426</b>	<b>27,624</b>	<b>33,117</b>
--------------------	--	---------------	---------------	---------------	---------------	---------------

\*Categorizing of Most Severe Referral was changed in 1992 to reflect new standards.

# Source of Referral

## Top 5 Referring Agencies

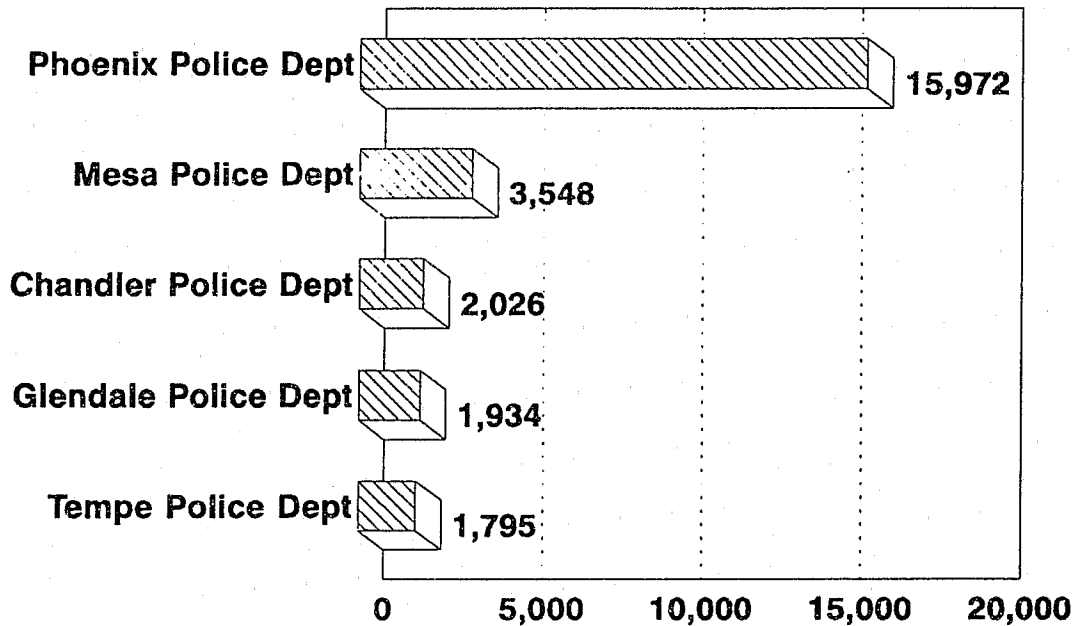

Delinquent and incorrigible (status) cases are referred to the court by law enforcement agencies, social service agencies, schools, parents, and probation officers. Law enforcement agencies are the primary source of referral. Overall, about 90% of all cases in 1993 were referred by law enforcement agencies.

The law enforcement agency that contributes the most referrals to the Juvenile Court is the Phoenix Police Department. In 1993, Phoenix sent 15,972 referrals, which accounts for 48% of all referrals received. Phoenix, Mesa, Chandler, Glendale and Tempe Police Departments comprise the top five sources of referrals received, accounting for 76% of all referrals to the Juvenile Court Center in 1993.

MARICOPA COUNTY JUVENILE COURT CENTER

Source of Referral for 1993

Origination of Referral 1993	Violent	Grand Theft	Obstrt	Fight	Drugs	Peace	Theft	Status	Hold	TOTAL
Avondale	39	67	6	51	35	61	44	4	65	372
Buckeye	9	26	3	5	7	20	13	0	45	128
Chandler	92	307	25	148	125	239	294	341	455	2,026
DPS (State)	9	36	5	2	37	26	9	13	11	148
El Mirago	15	20	3	22	16	30	20	1	28	155
Gila Bend	0	0	4	0	0	0	0	0	4	8
Gilbert	29	101	7	45	34	50	103	164	66	599
Glendale	198	344	68	289	129	291	467	35	113	1,934
Goodyear	9	15	1	12	4	9	29	2	0	81
Guadalupe	0	0	1	0	0	0	0	0	0	1
MCSO(County)	72	232	15	87	87	110	119	30	46	798
Mesa	228	697	23	347	243	488	1,143	79	300	3,548
Paradise Vfy	1	10	0	3	0	0	1	2	2	19
Peoria	55	89	4	48	51	69	150	14	28	508
Phoenix Police	1,058	2,460	104	1,056	786	1,150	3,193	403	5,762	15,972
Phoenix Fire	9	8	0	0	0	2	0	0	0	19
Scottsdale	52	177	14	95	73	150	236	38	44	879
Surprise	5	18	1	6	4	6	8	0	6	54
Tempe	93	306	22	125	89	276	444	378	62	1,795
Tolleson	9	7	0	9	11	10	18	2	8	74
Wickenburg	0	5	6	4	0	10	20	3	14	62
Youngtown	0	2	0	0	0	1	0	1	2	6
Other Law	12	42	6	11	19	54	43	62	67	316
<b>Sub Total</b>	<b>1,994</b>	<b>4,969</b>	<b>318</b>	<b>2,365</b>	<b>1,750</b>	<b>3,052</b>	<b>6,354</b>	<b>1,572</b>	<b>7,128</b>	<b>29,502</b>
<b>Court</b>	<b>0</b>	<b>0</b>	<b>155</b>	<b>1</b>	<b>1</b>	<b>3</b>	<b>0</b>	<b>5</b>	<b>48</b>	<b>213</b>
<b>Parent</b>	<b>0</b>	<b>0</b>	<b>1</b>	<b>0</b>	<b>0</b>	<b>0</b>	<b>0</b>	<b>688</b>	<b>0</b>	<b>689</b>
<b>Probation Off.</b>	<b>0</b>	<b>0</b>	<b>1,554</b>	<b>0</b>	<b>0</b>	<b>1</b>	<b>1</b>	<b>4</b>	<b>0</b>	<b>1,560</b>
<b>School</b>	<b>0</b>	<b>1</b>	<b>0</b>	<b>0</b>	<b>0</b>	<b>0</b>	<b>0</b>	<b>1,151</b>	<b>0</b>	<b>1,152</b>
<b>Other</b>	<b>0</b>	<b>0</b>	<b>0</b>	<b>0</b>	<b>0</b>	<b>0</b>	<b>0</b>	<b>0</b>	<b>1</b>	<b>1</b>
<b>Sub Total</b>	<b>0</b>	<b>1</b>	<b>1,710</b>	<b>1</b>	<b>1</b>	<b>4</b>	<b>1</b>	<b>1,848</b>	<b>49</b>	<b>3,615</b>
<b>TOTAL</b>	<b>1,994</b>	<b>4,970</b>	<b>2,028</b>	<b>2,366</b>	<b>1,751</b>	<b>3,056</b>	<b>6,355</b>	<b>3,420</b>	<b>7,177</b>	<b>33,117</b>

See Appendix A for Source of Referral by Zipcode

MARICOPA COUNTY JUVENILE COURT CENTER

Source of Referral 1988-1993

Origination of Referral	1989	1990	1991	1992	1993
Avondale	189	341	388	407	372
Buckeye	91	187	125	128	128
Chandler	1,024	1,233	1,322	1,480	2,026
DPS (State)	165	190	169	175	148
El Mirage	147	163	125	138	155
Gila Bend	0	2	0	2	8
Gilbert	483	605	602	471	599
Glendale	1,583	1,795	1,612	1,625	1,934
Goodyear	81	97	63	78	81
Guadalupe	104	49	8	5	1
MCSO (County Sheriff)	824	806	806	805	798
Mesa	3,146	3,704	3,370	3,183	3,548
Paradise Valley	22	28	8	4	19
Peoria	358	397	472	490	508
Phoenix Police Dept.	12,696	13,589	13,154	12,524	15,972
Phoenix Fire Dept.	0	0	25	14	19
Scottsdale	785	861	840	968	879
Surprise	100	82	101	69	54
Tempe	1,637	1,870	1,922	1,795	1,795
Tolleson	65	98	105	111	74
Wickenburg	105	86	56	84	62
Youngtown	3	14	7	3	6
Other Law Enforcement	306	291	375	397	316
<b>Sub Total</b>	<b>23,914</b>	<b>26,488</b>	<b>25,655</b>	<b>24,956</b>	<b>29,502</b>
Court	491	603	392	268	213
Parent	150	171	245	289	689
Probation Officer	935	752	1,185	1,252	1,560
School	731	992	938	851	1,152
DYTR	7	4	0	4	0
Other Not Listed Elsewhere	8	12	11	4	1
<b>Sub Total</b>	<b>2,322</b>	<b>2,534</b>	<b>2,771</b>	<b>2,608</b>	<b>3,615</b>
<b>TOTAL</b>	<b>26,236</b>	<b>29,022</b>	<b>28,426</b>	<b>27,624</b>	<b>33,117</b>

MARICOPA COUNTY JUVENILE COURT CENTER

**REFERRAL  
PROFILE**

**Sex of Referred**

Juveniles in 72.1% of the referrals were male in 1993. Female referrals accounted for 27.9%. The number of female referrals has increased from 23% of the total referrals in 1989 to 28% in 1993.

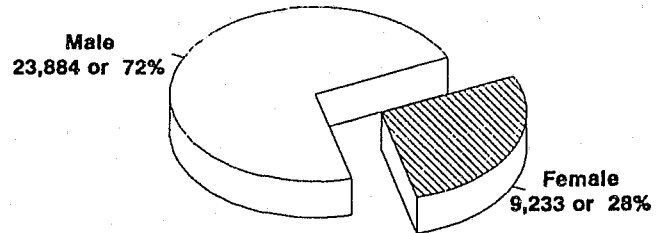

Sex of Referred 1993	Violent	Grand Theft	Obstruct	Fight	Drugs	Peace	Theft	Status	Hold	TOTAL
Female	249	797	473	674	329	586	2,051	4,054	20	9,233
Male	1,745	4,172	1,555	1,692	1,422	2,472	4,304	6,412	110	23,884
<b>TOTAL</b>	<b>1,994</b>	<b>4,969</b>	<b>2,028</b>	<b>2,366</b>	<b>1,751</b>	<b>3,058</b>	<b>6,355</b>	<b>10,466</b>	<b>130</b>	<b>33,117</b>

Sex of Referred	1989	1990	1991	1992	1993
Female	6,006	6,733	6,607	6,769	9,233
Male	20,230	22,289	21,819	20,855	23,884
<b>TOTAL</b>	<b>26,236</b>	<b>29,022</b>	<b>28,426</b>	<b>27,624</b>	<b>33,117</b>

# Age at Referral

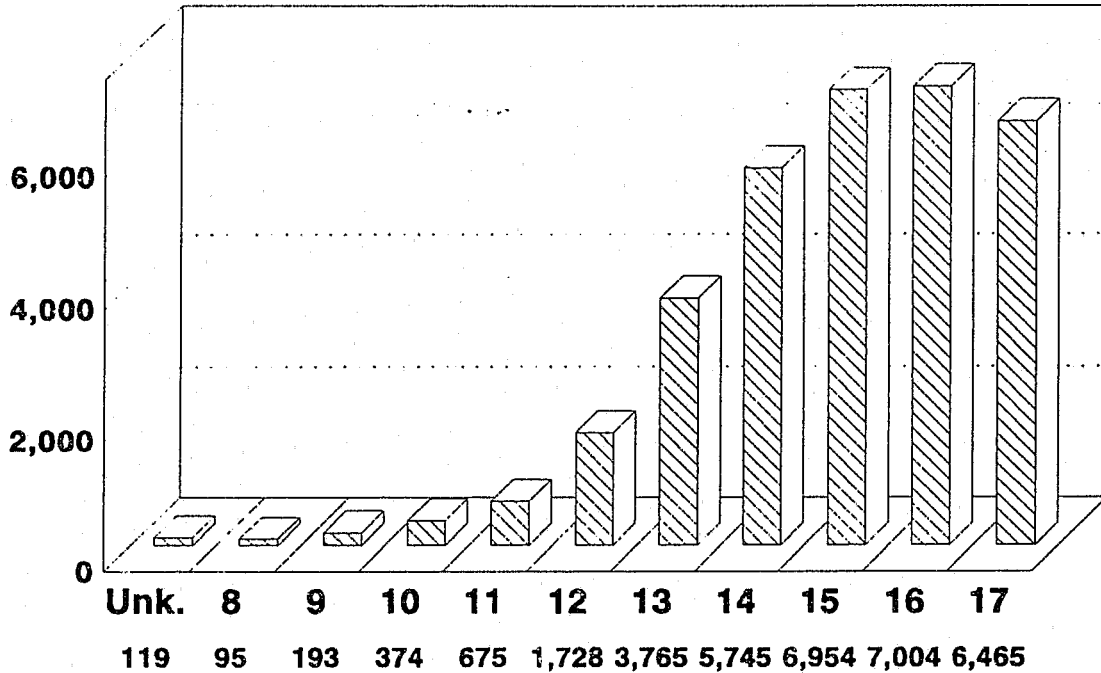

**Number of Referrals in Each Age Group**

The largest age category is comprised of 16 year olds with 7,004 referrals which represent 21.1% of all referrals in 1993. The next highest category of referrals is the 15 year olds, with 21% of the referrals.

Once a juvenile reaches the age of 18, the Juvenile Court loses all jurisdiction. Those juveniles ages 15 to 17 account for 62% of the total referrals received by the Juvenile Court.



## MARICOPA COUNTY JUVENILE COURT CENTER

Age at Referral 1993	Violent	Grand Theft	Obstruct	Fight	Drugs	Peace	Theft	Status	Hold	TOTAL
8 Years	3	19	0	6	3	12	33	19	0	95
9 Years	11	46	0	14	0	15	78	29	0	193
10 Years	19	75	2	37	3	30	163	45	0	374
11 Years	57	113	14	61	8	55	255	111	1	675
12 Years	118	268	37	187	37	127	550	400	4	1,728
13 Years	201	511	163	333	121	322	942	1,164	8	3,765
14 Years	290	810	313	390	269	494	1,124	2,038	17	5,745
15 Years	396	1,035	516	455	326	581	1,166	2,448	31	6,954
16 Years	421	1,083	535	456	504	672	1,104	2,203	26	7,004
17 Years	470	998	447	422	470	731	924	1,960	43	6,465
Unknown	8	11	1	5	10	19	16	49	0	119
<b>TOTAL</b>	<b>1,994</b>	<b>4,969</b>	<b>2,028</b>	<b>2,366</b>	<b>1,751</b>	<b>3,058</b>	<b>6,355</b>	<b>10,466</b>	<b>130</b>	<b>33,117</b>

Age at Referral	1989	1990	1991	1992	1993
8 Years	81	84	91	91	95
9 Years	206	206	188	204	193
10 Years	341	400	404	369	374
11 Years	670	717	725	626	675
12 Years	1,218	1,384	1,417	1,431	1,728
13 Years	2,566	3,005	2,971	2,948	3,765
14 Years	4,196	4,900	4,474	4,724	5,745
15 Years	5,225	5,808	5,624	5,401	6,954
16 Years	5,871	6,196	6,204	5,858	7,004
17 Years	5,702	6,203	6,219	5,861	6,465
Unknown	160	119	109	111	119
<b>TOTAL</b>	<b>26,236</b>	<b>29,022</b>	<b>28,426</b>	<b>27,624</b>	<b>33,117</b>

MARICOPA COUNTY JUVENILE COURT CENTER

Ethnicity of Referred

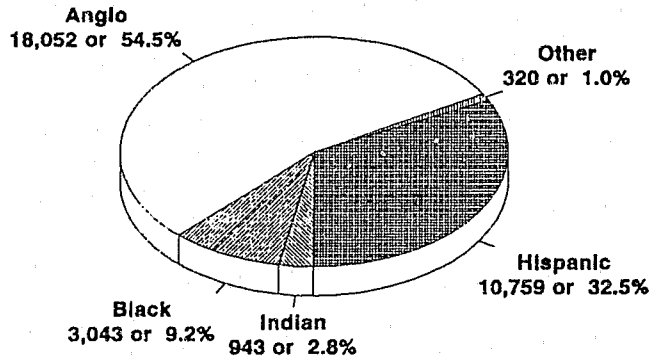

The racial-ethnic heritage of the referrals in 1993 is depicted in the pie chart. The Anglo category (Caucasian but not Hispanic), accounts for 54.5% of the referrals. Hispanic juveniles account for 32.5% and are the second largest category. African American (Black) juveniles account for 9.2%; Native American (Indian) account for 2.8%; Asian and other categories account for 1% according to ethnicity.

Ethnicity of Referred 1993	Offense Type							Theft	Status	Hold	TOTAL
	Violent	Grand Theft	Obstr	Fight	Drugs	Peace					
Anglo	826	2,712	1,028	1,353	905	1,662	3,884	5,599	83	18,052	
Black	358	461	198	272	114	345	627	659	9	3,043	
Hispanic	744	1,618	716	660	660	961	1,572	3,802	26	10,759	
Indian	57	132	70	68	63	77	202	270	4	943	
Oriental	8	33	13	10	8	10	57	54	0	193	
Other	1	13	3	3	1	3	13	79	8	124	
Unknown	0	0	0	0	0	0	0	3	0	3	
<b>TOTAL</b>	<b>1,994</b>	<b>4,969</b>	<b>2,028</b>	<b>2,366</b>	<b>1,751</b>	<b>3,058</b>	<b>6,355</b>	<b>10,466</b>	<b>130</b>	<b>33,117</b>	

Ethnicity of Referred	1989	1990	1991	1992	1993
Anglo	15,782	16,140	16,066	15,064	18,052
Black	2,789	3,081	2,810	2,715	3,043
Hispanic	6,742	8,731	8,570	8,860	10,759
Indian	740	843	758	754	943
Other or Unknown	183	227	222	231	320
<b>TOTAL</b>	<b>26,236</b>	<b>29,022</b>	<b>28,426</b>	<b>27,624</b>	<b>33,117</b>

## School Status of Referred

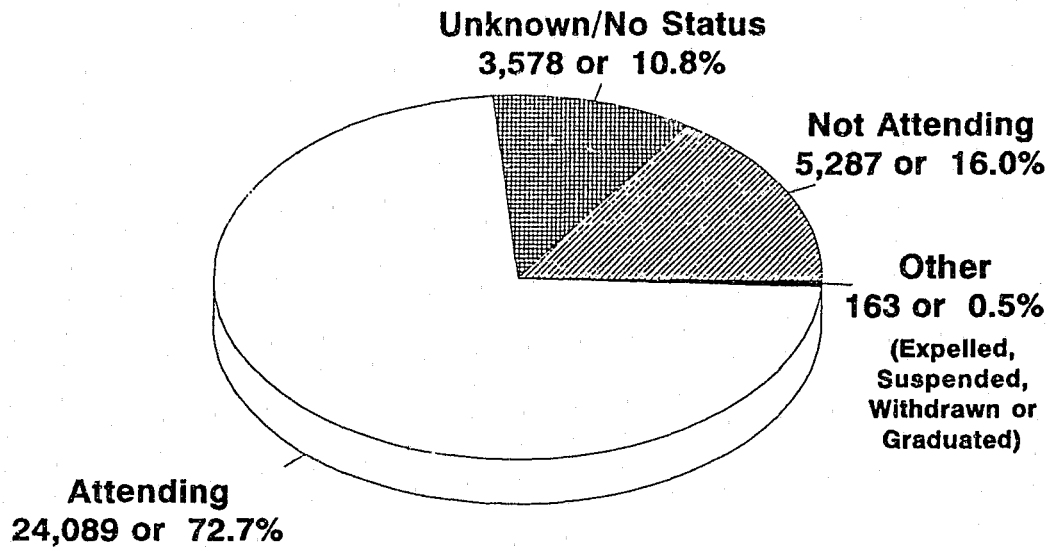

At receipt of referral, 72.7% or about 3 of every 4 juveniles were attending school. An additional 16.0% were reported as not attending school at time of referral, while the school status of 10.8% was unknown or had no status.

A small percentage (0.5%) were either expelled, suspended, withdrawn, or graduated juveniles. These data have remained consistent over many years.

**MARICOPA COUNTY JUVENILE COURT CENTER**

School Status of Referred 1993	Violent	Grand Theft	Obstr	Fight	Drugs	Peace	Theft	Status	Hold	TOTAL
Attending	1,422	3,653	1,403	1,861	1,248	2,344	5,334	6,781	43	24,089
Expelled	6	9	7	3	3	5	8	14	0	55
Graduated	2	2	4	0	0	1	3	6	0	18
Not	479	1,026	537	372	385	520	699	1,248	21	5,287
Suspended	4	12	7	9	6	8	6	14	0	66
Withdrawn	2	2	3	1	4	6	2	4	0	24
Unknown/No Status	79	265	67	120	105	174	303	2,399	66	3,578
<b>TOTAL</b>	<b>1,994</b>	<b>4,969</b>	<b>2,028</b>	<b>2,366</b>	<b>1,751</b>	<b>3,058</b>	<b>6,355</b>	<b>10,466</b>	<b>130</b>	<b>33,117</b>

School Status of Referred	1989	1990	1991	1992	1993
Attending	19,620	21,710	20,942	20,383	24,089
Expelled	41	85	68	53	55
Graduated	40	56	35	20	18
Not Attending	3,441	4,496	5,391	5,041	3,578
Suspended	72	78	57	42	66
Withdrawn	16	8	9	17	24
Unknown	3,006	2,589	1,924	2,068	5,287
<b>TOTAL</b>	<b>26,236</b>	<b>29,022</b>	<b>28,426</b>	<b>27,624</b>	<b>33,117</b>

## MARICOPA COUNTY JUVENILE COURT CENTER

School Grade of Referred 1993	Violent	Grand Theft	Obstr	Fight	Drugs	Peace	Theft	Status	Hold	TOTAL
First	0	0	0	0	0	0	2	2	0	4
Second	2	10	0	3	1	8	20	15	0	59
Third	8	28	1	10	2	13	56	27	0	145
Fourth	15	79	6	37	2	27	137	73	1	377
Fifth	47	96	22	61	14	47	223	140	1	651
Sixth	96	194	58	104	35	115	414	328	3	1,347
Seventh	182	467	154	302	115	256	817	880	5	3,178
Eighth	266	690	263	366	196	432	992	1,435	8	4,648
Ninth	291	822	428	406	302	507	1,003	1,584	13	5,356
Tenth	258	691	284	301	288	446	859	1,045	7	4,179
Eleventh	180	428	135	174	213	323	563	529	3	2,548
Twelfth	66	150	38	89	77	151	246	177	0	994
College	6	14	1	3	2	4	16	10	0	56
Vocation	2	1	4	1	3	0	1	8	1	21
GED	4	14	21	2	6	7	9	17	1	81
Not Attending	413	861	517	317	315	416	550	1,098	17	4,504
Unknown	158	424	96	190	180	306	447	3,098	70	4,969
<b>TOTAL</b>	<b>1,994</b>	<b>4,969</b>	<b>2,028</b>	<b>2,366</b>	<b>1,751</b>	<b>3,058</b>	<b>6,355</b>	<b>10,466</b>	<b>130</b>	<b>33,117</b>

School Grade of Referred	1989	1990	1991	1992	1993
First	3	7	4	9	4
Second	69	50	48	60	59
Third	149	198	190	156	145
Fourth	347	367	380	342	377
Fifth	604	645	644	613	651
Sixth	917	1,148	1,189	1,087	1,347
Seventh	2,492	2,893	2,740	2,696	3,178
Eighth	3,393	3,943	3,684	3,854	4,648
Ninth	4,067	4,393	4,273	4,311	5,356
Tenth	3,533	3,755	3,747	3,541	4,179
Eleventh	2,407	2,457	2,369	2,215	2,548
Twelfth	1,112	1,100	1,113	1,006	994
College	40	69	59	45	56
Vocational Training & GED	79	129	65	98	102
Not Attending	2,956	3,634	4,585	4,378	4,504
Unknown	4,068	4,034	3,336	3,213	4,969
<b>TOTAL</b>	<b>26,236</b>	<b>29,022</b>	<b>28,426</b>	<b>27,624</b>	<b>33,117</b>

## MARICOPA COUNTY JUVENILE COURT CENTER

School District of Referred 1993	Grand									TOTAL
	Violent	Theft	Obstr	Fight	Drugs	Peace	Theft	Status	Hold	
Agua Fria Union	20	29	13	18	14	38	23	51	0	204
Aguila Elementary	0	4	0	0	0	0	0	0	0	4
Alhambra	29	83	23	62	12	36	106	103	2	456
Arlington Elem	0	0	0	0	0	1	0	0	0	1
Avondale Elem	13	19	4	17	5	12	44	34	0	148
Balsz Elem	6	18	2	4	1	7	21	30	0	89
Buckeye Elem	1	12	1	1	2	0	12	11	0	40
Buckeye Union	10	24	9	4	7	16	18	35	0	123
Cartwright Elem	43	129	53	54	37	51	197	305	0	869
Cave Ck Unified	1	2	5	3	3	10	20	34	0	78
Chandler Unified	49	116	64	81	64	108	137	377	0	996
Croighton Elem	23	80	29	27	24	18	79	139	0	419
Deer Vly Unified	54	169	65	84	55	102	186	266	3	964
Dysart Unified	28	56	13	22	24	34	43	46	1	267
Fountain Hill Unif.	8	12	0	11	7	5	23	5	1	72
Fowler Elem	2	2	1	3	3	4	15	11	0	41
Gila Bend Unified	3	12	2	7	2	3	3	7	0	39
Gilbert Unified	23	99	28	44	25	48	118	188	0	573
Glendale Elem	34	58	38	59	11	49	138	86	0	473
Glendale Union	100	225	160	122	100	132	285	470	3	1,597
Higley Elem	0	1	1	0	0	1	0	0	0	3
Horse Mesa Acc.	28	38	38	24	30	45	45	100	1	347
Isaac Elem	31	61	31	29	20	37	121	196	0	526
Kyrene Elem	10	20	10	18	6	24	38	32	1	159
Laveen Elem	2	16	3	5	1	2	9	5	0	43
Liberty Elem	0	1	0	2	1	0	0	1	0	5
Litchfield Elem	0	1	0	0	0	0	0	0	0	1
Littleton Elem	4	11	1	4	2	7	8	18	0	55
Madison Elem	6	14	8	6	5	4	31	55	0	129
Mesa Unified	219	624	216	297	214	463	888	649	6	3,576
Murphy Elem	14	33	12	8	12	9	19	51	2	160
Nadaburg Elem	3	3	1	4	1	4	6	6	0	28
Osborn Elem	20	51	5	21	4	13	61	75	0	250
Palo Verde Elem	0	0	0	0	0	0	1	2	0	3
Paloma Elem	1	0	0	0	0	0	0	0	0	1
Paradise Vly. Unif.	60	234	90	98	101	146	379	843	3	1,954
Pendergast Elem	10	26	6	21	5	7	54	38	0	167
Peoria Unified	78	136	58	102	62	122	259	156	3	976
Phoenix Elem	85	150	56	34	36	55	69	240	2	727
Phoenix Union	375	780	343	267	265	404	742	1,406	7	4,589
Queen Ck Unified	1	3	3	4	4	9	9	3	0	36
Riverside Elem	0	5	2	1	7	0	2	4	1	22
Roosevelt Elem	46	114	44	49	25	54	105	201	1	639
Scottsdale Unified	43	161	57	93	69	139	217	250	2	1,031
Sentinel Elem	0	0	0	0	0	0	1	0	0	1
Tempe Elem	34	110	20	44	20	56	156	173	1	614
Tempe Union	62	193	87	94	82	152	311	370	0	1,351
Tolleson Elem	5	3	1	4	0	6	13	8	0	40
Tolleson Union	25	71	39	29	33	31	75	157	0	460
Union Elem	0	5	0	0	0	0	1	0	0	6
Washington Elem	58	118	55	97	30	68	276	426	0	1,128
Wickenburg Unif.	0	5	5	9	0	10	20	11	1	61
Wilson Elem	2	6	1	2	1	2	3	20	0	37
WAFB Accom.	0	0	0	1	0	2	3	4	0	10
Other	117	243	144	148	88	157	342	355	15	1,609
Misc. Other	25	79	67	40	21	45	44	95	2	418
Misc. Parochial	6	18	7	10	10	16	41	64	0	172
College	10	12	5	3	4	5	11	16	0	66
Unknown	169	474	102	175	196	291	527	2,238	72	4,244
<b>TOTAL</b>	<b>1,994</b>	<b>4,969</b>	<b>2,028</b>	<b>2,366</b>	<b>1,751</b>	<b>3,058</b>	<b>6,355</b>	<b>10,466</b>	<b>130</b>	<b>33,117</b>

# School District of Referred Top 10 School Districts

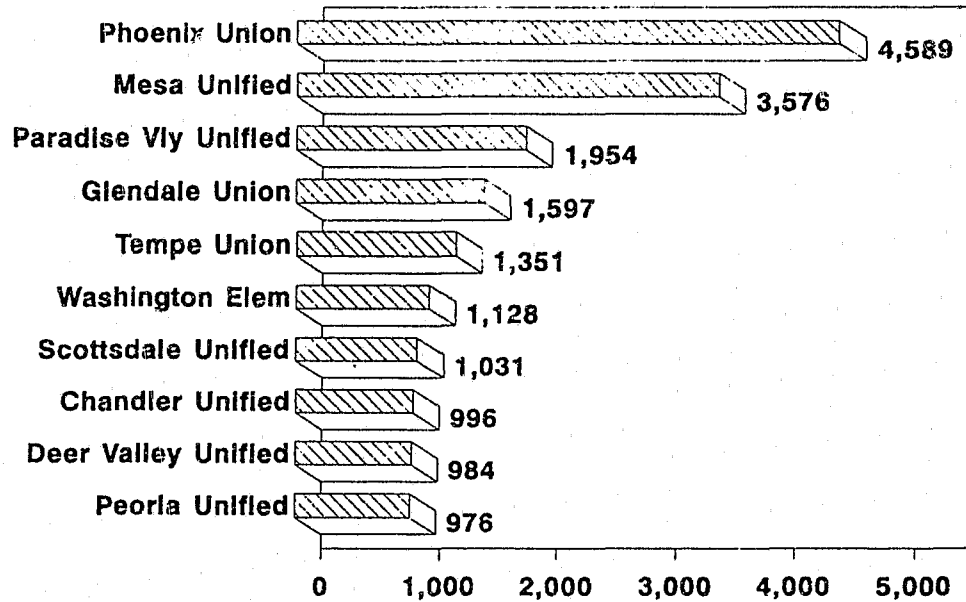

See Appendix B for Referrals by Actual Schools within each School District.

MARICOPA COUNTY JUVENILE COURT CENTER

School District of Referred	1989	1990	1991	1992	1993
Agua Fria Elementary	166	217	209	206	204
Agua Fria Elementary	0	0	0	1	4
Alhambra Elementary	288	396	467	438	456
Arlington Elementary	1	2	0	0	1
Avondale Elementary	137	207	179	156	148
Balsz Elementary	95	87	70	102	89
Buckeye Elementary	40	84	50	47	40
Buckeye Union	70	98	90	87	123
Cartwright Elementary	638	787	694	639	809
Cave Creek Elementary	30	38	25	45	78
Chandler Unified	513	642	*745	816	996
Creighton Elementary	326	385	342	358	419
Deer Valley Unified	766	841	929	784	984
Dysart Unified	72	124	*293	228	267
Fountain Hills Unified	12	30	28	24	72
Fowler Elementary	40	32	26	46	41
Gila Bend Unified	7	15	*53	33	39
Gilbert Unified	184	235	*643	516	573
Glendale Elementary	378	493	439	461	473
Glendale Union	1,554	1,553	1,498	1,465	1,597
Higley Elementary	5	1	0	4	3
Horse Mesa Accom.	0	0	44	266	347
Isaac Elementary	355	358	344	374	526
Kyrene Elementary	111	116	119	158	159
Laveen Elementary	72	64	56	43	43
Liberty Elementary	7	14	23	13	5
Litchfield Elementary	9	19	17	6	1
Littleton Elementary	31	45	34	26	55
Madison Elementary	119	181	115	93	129
Mesa Unified	2,554	2,922	*3,491	2,978	3,576
Mobile Elementary	0	2	3	3	0
Morristown Elementary	0	2	0	0	0
Murphy Elementary	170	181	132	108	160
Nadaburg Elementary	15	21	15	20	28
Osborn Elementary	134	173	176	245	250
Palo Verde Elementary	0	7	14	8	3
Paloma Elementary	0	1	1	0	1
Paradise Valley Unified	632	597	*1,378	1,524	1,954
Pendergast Elementary	89	99	131	129	167
Peoria Unified	588	581	*831	860	976
Phoenix Elementary	755	919	770	595	727
Phoenix Union	4,301	4,691	4,581	4,041	4,589
Queen Creek Unified	23	23	29	34	36
Riverside Elementary	1	0	5	25	22
Roosevelt Elementary	452	477	499	521	639
Ruth Fisher Elementary	3	2	2	7	0



## MARICOPA COUNTY JUVENILE COURT CENTER

School District of Referred	1989	1990	1991	1992	1993
Scottsdale Unified	339	414	*858	882	1,031
Sentinel Elementary	0	0	0	0	1
Tempe Elementary	428	548	519	509	614
Tempe Union	1,205	1,277	1,217	1,212	1,351
Tolleson Elementary	46	40	57	56	40
Tolleson Union	241	223	308	391	460
Union Elementary	1	1	0	3	6
Washington Elementary	863	892	932	971	1,128
Wickenburg Unified	16	20	*49	64	61
Wilson Elementary	34	61	43	37	37
Williams AFB Accom.	14	13	10	20	10
Other	1,487	1,636	1,980	1,897	2,265
Unknown	5,819	6,135	2,868	3,049	4,244
<b>TOTAL</b>	<b>26,236</b>	<b>29,022</b>	<b>28,426</b>	<b>27,624</b>	<b>33,117</b>

\*Changes in school coding for 1991 may have caused referrals to reflect an substantial increase, previous years referrals were placed in the "Unknown" category.

# Number of Previous Referrals

Based on 33,117 Total Referrals for 1993

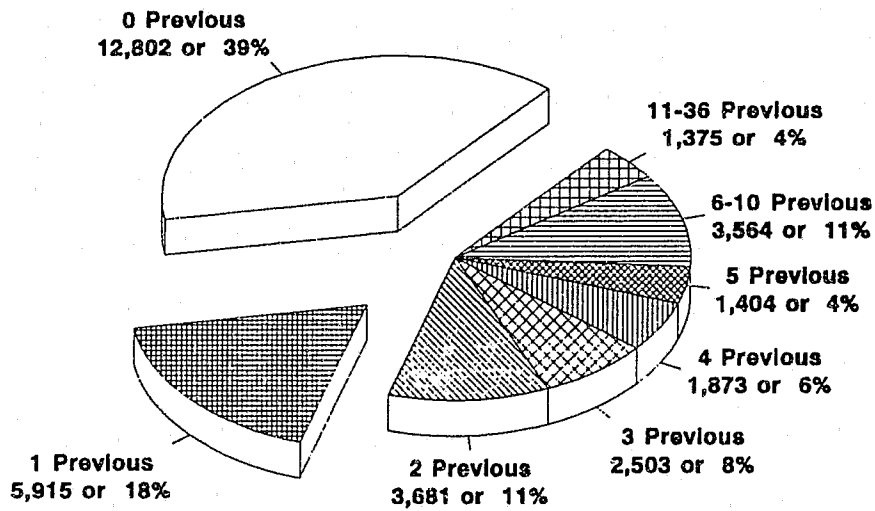

## MARICOPA COUNTY JUVENILE COURT CENTER

Number of Previous Referrals 1993	Violent	Grand Theft	Obstr	Fight	Drugs	Peace	Theft	Status	Hold	TOTAL
0 Previous	624	1,633	90	923	595	1,139	3,775	3,958	65	12,802
1 Previous	343	879	190	455	304	579	1,026	2,121	18	5,915
2 Previous	217	556	260	269	226	370	513	1,258	12	3,681
3 Previous	152	393	286	183	147	219	308	805	10	2,503
4 Previous	133	292	291	140	100	170	192	551	4	1,873
5 Previous	96	242	254	67	73	117	135	417	3	1,404
6 Previous	66	204	184	81	62	100	101	304	6	1,108
7 Previous	72	145	133	56	44	78	82	236	3	849
8 Previous	56	128	106	28	47	67	45	183	1	661
9 Previous	50	126	71	31	41	42	43	132	1	537
10 Previous	35	75	46	41	25	44	31	110	2	409
11 Previous	30	65	39	19	15	31	29	81	3	312
12 Previous	29	40	23	15	14	27	16	64	1	229
13 Previous	14	34	19	15	13	17	13	41	1	167
14 Previous	12	36	7	7	11	8	9	43	0	133
15 Previous	8	30	10	7	14	15	7	26	0	117
16 Previous	12	23	6	4	5	6	7	29	0	92
17 Previous	13	13	5	6	3	7	5	20	0	72
18 Previous	7	11	2	6	4	3	5	15	0	53
19 Previous	5	9	1	4	3	2	5	9	0	38
20 Previous	3	4	2	2	0	4	3	9	0	27
21 Previous	6	9	0	0	0	3	1	9	0	28
22 Previous	4	3	0	2	1	2	0	5	0	17
23 Previous	1	2	0	2	0	2	0	6	0	13
24 Previous	2	2	0	0	2	0	0	3	0	9
25 Previous	1	1	1	1	0	1	1	2	0	8
26 Previous	0	3	0	0	0	0	0	6	0	9
27 Previous	1	2	0	1	1	0	0	6	0	11
28 Previous	1	2	0	0	1	1	0	2	0	7
29 Previous	0	2	0	0	0	1	0	6	0	9
30 Previous	0	2	0	1	0	0	0	2	0	5
31 Previous	1	1	0	0	0	1	2	0	0	5
32-36 Previous	0	2	2	0	0	2	1	7	0	14
<b>TOTAL</b>	<b>1,994</b>	<b>4,969</b>	<b>2,028</b>	<b>2,366</b>	<b>1,751</b>	<b>3,058</b>	<b>6,355</b>	<b>10,466</b>	<b>130</b>	<b>33,117</b>

**MARICOPA COUNTY JUVENILE COURT CENTER**

<b>Number of Previous Referrals</b>	<b>1989</b>	<b>1990</b>	<b>1991</b>	<b>1992</b>	<b>1993</b>
<b>0 Previous</b>	10,883	11,284	10,888	10,715	12,802
<b>1 Previous</b>	4,608	5,035	4,875	4,700	5,915
<b>2 Previous</b>	2,769	3,137	2,391	2,890	3,681
<b>3 Previous</b>	1,926	2,150	2,126	2,078	2,503
<b>4 Previous</b>	1,441	1,627	1,542	1,573	1,873
<b>5 Previous</b>	1,132	1,265	1,211	1,197	1,404
<b>6 Previous</b>	867	1,025	971	931	1,108
<b>7 Previous</b>	696	798	783	775	849
<b>8 Previous</b>	538	623	632	603	661
<b>9 Previous</b>	400	496	479	461	537
<b>10 or more Previous</b>	976	1,582	1,928	1,701	1,784
<b>TOTAL</b>	<b>26,236</b>	<b>29,022</b>	<b>28,426</b>	<b>27,624</b>	<b>33,117</b>

# First Time Offenders

## Severity of Referral

39% of All Referrals Received in 1993

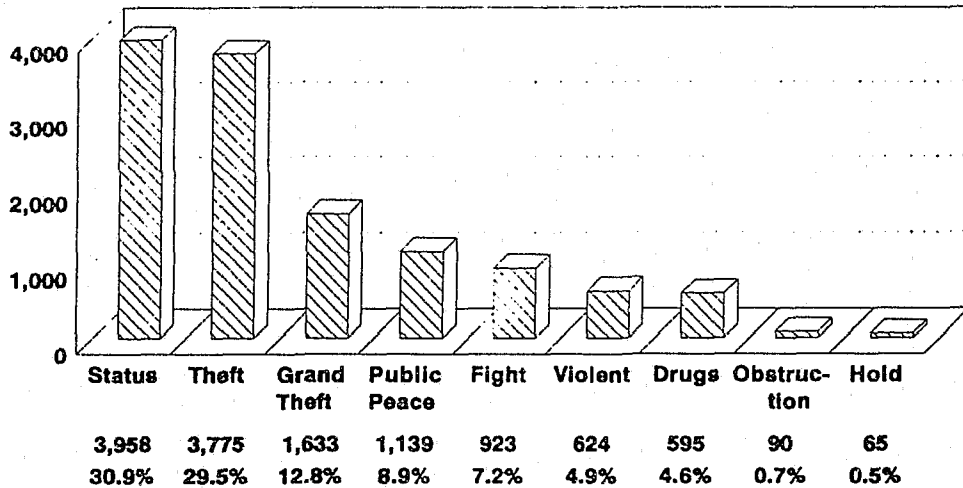

Number of Delinquent & Incurable Referrals  
Percentage Based on 12,802 Total Referrals in 1993

FIRST OFFENDER Severity of Referral	1989	1990	1991	1992	1993
Violent	445	538	595	621	624
Grand Theft	2,179	2,077	2,016	1,772	1,633
Obstruction	72	78	88	91	90
Fight	701	810	830	919	923
Drugs	355	289	289	367	595
Peace	976	1,149	1,068	1,125	1,139
Theft	3,767	3,849	3,712	3,635	3,775
Status	2,313	2,432	2,213	2,130	3,958
Hold	75	63	77	55	65
<b>TOTAL</b>	<b>10,883</b>	<b>11,283</b>	<b>10,888</b>	<b>10,715</b>	<b>12,802</b>
Percentage of All Referrals Received	42%	39%	38%	39%	39%

**MARICOPA COUNTY JUVENILE COURT CENTER**

**FIRST OFFENDER**

Sex of Referred 1993	Violent	Grand Theft	Obstruct	Fight	Drugs	Peace	Theft	Status	Hold	TOTAL
Female	98	367	23	354	162	250	1,467	1,921	11	4,653
Male	526	1,266	67	569	433	689	2,308	2,037	54	8,149
<b>TOTAL</b>	<b>624</b>	<b>1,633</b>	<b>90</b>	<b>923</b>	<b>595</b>	<b>1,139</b>	<b>3,775</b>	<b>3,958</b>	<b>65</b>	<b>12,802</b>

Sex of Referred	1989	1990	1991	1992	1993
Female	3,378	3,661	3,466	3,568	4,653
Male	7,505	7,622	7,422	7,147	8,149
<b>TOTAL</b>	<b>10,883</b>	<b>11,283</b>	<b>10,888</b>	<b>10,715</b>	<b>12,802</b>

Ethnicity of Referred 1993	Violent	Grand Theft	Obstr	Fight	Drugs	Peace	Theft	Status	Hold	TOTAL
Anglo	329	981	50	559	336	697	2,362	2,369	48	7,731
Black	86	112	6	100	28	97	335	194	2	960
Hispanic	196	463	30	235	208	309	904	1,238	5	3,588
Indian	10	57	4	23	21	26	127	75	2	345
Oriental	3	14	0	5	2	8	38	25	0	95
Other	0	6	0	1	0	2	9	54	8	80
Unknown	0	0	0	0	0	0	0	3	0	3
<b>TOTAL</b>	<b>624</b>	<b>1,633</b>	<b>90</b>	<b>923</b>	<b>595</b>	<b>1,139</b>	<b>3,775</b>	<b>3,958</b>	<b>65</b>	<b>12,802</b>

Ethnicity of Referred	1989	1990	1991	1992	1993
Anglo	7,422	7,148	6,901	6,418	7,731
Black	804	935	821	860	960
Hispanic	2,284	2,741	2,776	3,041	3,588
Indian	280	346	285	268	345
Other or Unknown	93	113	105	128	178
<b>TOTAL</b>	<b>10,883</b>	<b>11,283</b>	<b>10,888</b>	<b>10,715</b>	<b>12,802</b>

MARICOPA COUNTY JUVENILE COURT CENTER

FIRST OFFENDER

Age at Referral 1993	Violent	Grand Theft	Obstruct	Fight	Drugs	Peace	Theft	Status	Hold	TOTAL
8 Years	2	17	0	5	1	9	31	15	0	80
9 Years	10	38	0	11	0	12	68	20	0	159
10 Years	10	61	0	29	0	23	128	32	0	283
11 Years	38	72	1	44	6	31	194	62	1	449
12 Years	68	143	2	102	13	78	415	193	4	1,018
13 Years	92	212	6	157	63	159	636	487	6	1,818
14 Years	107	289	13	152	107	205	669	754	12	2,308
15 Years	102	260	21	161	104	189	621	891	13	2,382
16 Years	105	258	25	143	163	209	554	808	13	2,278
17 Years	86	257	22	117	135	219	448	681	16	1,981
Unknown	4	6	0	2	3	5	11	15	0	46
<b>TOTAL</b>	<b>624</b>	<b>1,633</b>	<b>90</b>	<b>923</b>	<b>595</b>	<b>1,139</b>	<b>3,775</b>	<b>3,958</b>	<b>65</b>	<b>12,802</b>

Age at Referral	1989	1990	1991	1992	1993
8 Years	76	78	84	82	80
9 Years	187	182	167	167	159
10 Years	276	325	313	290	283
11 Years	468	532	476	451	449
12 Years	782	838	854	850	1,018
13 Years	1,322	1,517	1,455	1,502	1,818
14 Years	1,758	1,930	1,815	1,962	2,308
15 Years	1,972	1,972	1,897	1,818	2,382
16 Years	2,011	1,990	1,951	1,822	2,278
17 Years	1,961	1,876	1,836	1,732	1,981
Unknown	70	43	40	39	46
<b>TOTAL</b>	<b>10,883</b>	<b>11,283</b>	<b>10,888</b>	<b>10,715</b>	<b>12,802</b>

MARICOPA COUNTY JUVENILE COURT CENTER

FIRST OFFENDER

School Grade of Referred 1993	Violent	Grand Theft	Obst	Fight	Drugs	Peace	Theft	Status	Hold	TOTAL
First	0	0	0	0	0	0	2	2	0	4
Second	1	7	0	2	1	7	16	6	0	40
Third	6	19	0	6	0	5	49	12	0	97
Fourth	10	54	0	25	1	15	108	21	0	234
Fifth	24	56	0	39	5	30	154	36	0	344
Sixth	52	91	3	57	4	57	290	65	1	620
Seventh	78	180	6	137	52	114	540	169	1	1,297
Eighth	95	257	6	152	81	160	589	276	0	1,616
Ninth	73	209	9	141	90	175	570	298	2	1,567
Tenth	80	186	14	96	94	135	474	225	2	1,306
Eleventh	53	134	7	60	86	124	323	149	1	937
Twelfth	19	55	4	40	28	65	147	52	0	410
College	1	6	0	1	0	0	7	0	0	15
Voc. Training	0	0	0	1	2	4	0	2	1	10
Not Attending	19	58	3	22	28	21	127	73	2	353
Unknown	113	321	38	144	123	227	379	2,552	55	3,952
<b>TOTAL</b>	<b>624</b>	<b>1,633</b>	<b>90</b>	<b>923</b>	<b>595</b>	<b>1,139</b>	<b>3,775</b>	<b>3,958</b>	<b>65</b>	<b>12,802</b>

School Grade of Referred	1989	1990	1991	1992	1993
First	3	7	4	9	4
Second	56	43	42	52	40
Third	112	138	146	125	97
Fourth	241	254	252	231	234
Fifth	370	378	376	358	344
Sixth	533	646	624	590	620
Seventh	1,034	1,164	1,135	1,186	1,297
Eighth	1,290	1,394	1,374	1,449	1,616
Ninth	1,344	1,402	1,378	1,376	1,567
Tenth	1,279	1,143	1,165	1,132	1,306
Eleventh	895	887	853	858	937
Twelfth	484	445	471	417	410
College	5	10	16	11	15
Vocational Training & GED	12	18	4	6	10
Not Attending	115	320	397	326	353
Unknown	3,110	3,034	2,651	2,589	3,952
<b>TOTAL</b>	<b>10,883</b>	<b>11,283</b>	<b>10,888</b>	<b>10,715</b>	<b>12,802</b>



# Detention

## Juveniles Brought to Detention Screening and Juveniles Detained

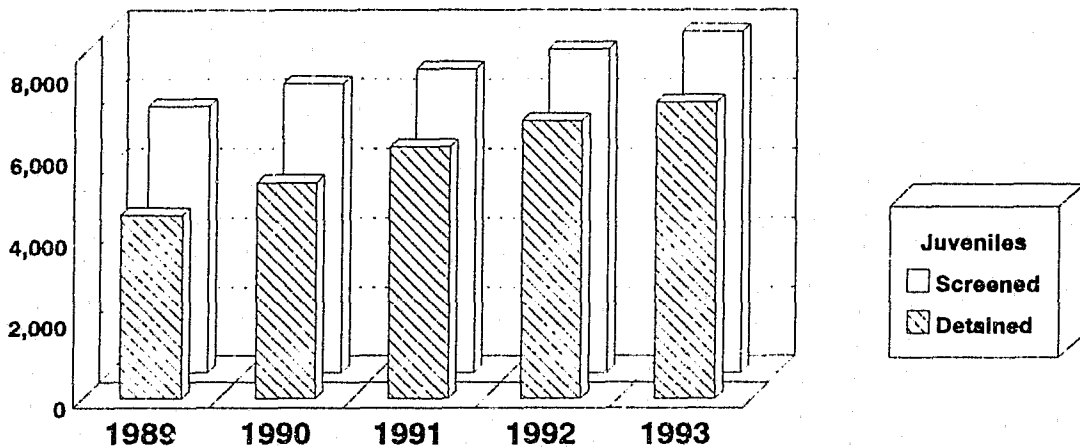

	1989	1990	1991	1992	1993
Screened	6,549	7,100	7,464	7,938	8,376
Detained	4,514	5,316	6,187	6,822	7,273
% Detained	68.9%	74.9%	82.9%	85.9%	86.8%

During 1993, there were 8,376 requests for detention. This resulted in detention of a juvenile 7,273 times, or 86.8% of the requests. A request for detention may occur when a Police Officer believes, for the safety of the community or the juvenile, that physical detention may be required. The juvenile is taken to either of the two Maricopa County Juvenile Detention Centers and interviewed by an Intake Screening Officer.

Based upon Supreme Court Rules and the Court Center's administrative criteria, the Intake Screening Officer has the option to release the juvenile to the parents or physically detain the juvenile pending court action. Intake Screeners are available 24 hours a day, seven days a week. If the juvenile is detained, a petition must be filed by the County Attorney, and a detention hearing held within 24 hours.

# Detention

## Average Daily Population, Length of Stay and Cost Per Juvenile

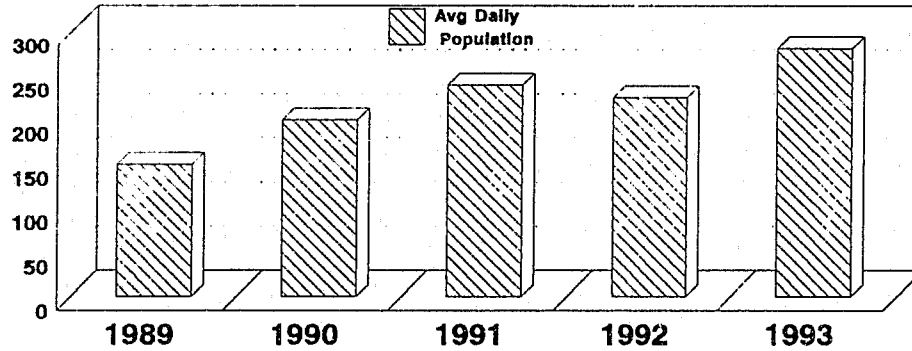

Avg Daily Population	149	199	239	225	281
Avg Days In Detention	11.3	13.3	13.6	11.8	13.3
Avg Daily Cost/Juv.	\$ 69.56	\$ 79.33	\$ 83.51	\$ 93.32	\$ 68.53

In 1993, 7,273 juveniles were detained. Of those, 3,417 were detained for delinquent or incorrigible acts, and the remainder of 3,856 juveniles were detained for such reasons as: court holds, courtesy holds, family counseling, family crisis, FOJ (from other jurisdiction), warrants, and home detention.

The average daily population in detention (including both facilities) was 281 juveniles. The average (mean) length of stay was 13.3 days. Length of stay does not have a normal distribution. Most juveniles stay less than 13 days while those who stay longer remain much longer than the 1993 average might suggest. The cost of a juvenile per day in detention was

\$68.53 in 1993. The reduction in cost is the result of over-crowding in detention in 1993.

### 1993

#### Detainee Profile

- Sex: Male (80%)
- Average Age: 15 yrs. 3 mths.
- Ethnicity: Minority (57%)
- School Status: Attending (61%)
- Severity: Grand Theft (30%)
- Offense: Vehicle Theft (13%)

**MARICOPA COUNTY JUVENILE COURT CENTER**

**JUVENILES DETAINED  
On Delinquent Referrals**

<b>Breakdown of Each Facility</b>	<b>Durango Facility</b>	<b>Southeast Facility</b>
<b>Total Juveniles Brought to Detention</b>	<b>5,077</b>	<b>3,299</b>
<b>Total Juveniles Detained</b>	<b>4,330</b>	<b>2,943</b>
<b>Average Daily Population</b>	<b>144.4</b>	<b>136.6</b>

<b>Severity of Referral</b>	<b>1989</b>	<b>1990</b>	<b>1991</b>	<b>1992</b>	<b>1993</b>
<b>Violent</b>	367	546	676	677	760
<b>Grand Theft</b>	624	1,055	1,135	1,178	1,020
<b>Obstruction</b>	51	44	75	66	91
<b>Fight</b>	268	355	374	385	365
<b>Drugs</b>	116	126	192	257	332
<b>Peace</b>	176	192	309	265	290
<b>Theft</b>	129	168	177	178	235
<b>Status</b>	281	286	240	205	302
<b>Hold</b>	1,048	1,159	248	20	22
<b>TOTAL</b>	<b>3,060</b>	<b>3,931</b>	<b>3,426</b>	<b>3,231</b>	<b>3,417</b>

<b>Sex of Referred</b>	<b>1989</b>	<b>1990</b>	<b>1991</b>	<b>1992</b>	<b>1993</b>
<b>Female</b>	691	788	584	551	697
<b>Male</b>	2,369	3,143	2,842	2,680	2,720
<b>TOTAL</b>	<b>3,060</b>	<b>3,931</b>	<b>3,426</b>	<b>3,231</b>	<b>3,417</b>

<b>Ethnicity of Referred</b>	<b>1989</b>	<b>1990</b>	<b>1991</b>	<b>1992</b>	<b>1993</b>
<b>Anglo</b>	1,507	1,685	1,433	1,412	1,460
<b>Black</b>	494	618	527	491	452
<b>Hispanic</b>	914	1,451	1,325	1,206	1,372
<b>Indian</b>	118	150	116	105	108
<b>Other or Unknown</b>	27	27	25	17	25
<b>TOTAL</b>	<b>3,060</b>	<b>3,931</b>	<b>3,426</b>	<b>3,231</b>	<b>3,417</b>

**MARICOPA COUNTY JUVENILE COURT CENTER**

**JUVENILES DETAINED  
On Delinquent Referrals**

<b>Age at Referral</b>	<b>1989</b>	<b>1990</b>	<b>1991</b>	<b>1992</b>	<b>1993</b>
<b>8 Years</b>	0	4	2	2	0
<b>9 Years</b>	3	3	2	5	3
<b>10 Years</b>	12	6	13	10	12
<b>11 Years</b>	26	25	36	26	32
<b>12 Years</b>	83	81	74	102	97
<b>13 Years</b>	198	310	248	241	291
<b>14 Years</b>	510	648	517	499	513
<b>15 Years</b>	653	659	731	673	762
<b>16 Years</b>	778	1,021	899	823	855
<b>17 Years</b>	790	969	900	839	847
<b>Unknown</b>	7	5	4	11	5
<b>TOTAL</b>	<b>3,060</b>	<b>3,931</b>	<b>3,426</b>	<b>3,231</b>	<b>3,417</b>

<b>Number of Previous Referrals</b>	<b>1989</b>	<b>1990</b>	<b>1991</b>	<b>1992</b>	<b>1993</b>
<b>0 Previous</b>	635	761	750	733	769
<b>1 Previous</b>	340	462	429	399	435
<b>2 Previous</b>	341	433	375	381	340
<b>3 Previous</b>	322	397	356	336	330
<b>4 Previous</b>	273	386	296	275	286
<b>5 Previous</b>	265	309	236	245	234
<b>6 Previous</b>	217	284	196	160	196
<b>7 Previous</b>	186	222	183	159	162
<b>8 Previous</b>	139	167	132	128	149
<b>9 Previous</b>	94	140	116	97	118
<b>10 or more Previous</b>	248	370	357	298	378
<b>TOTAL</b>	<b>3,060</b>	<b>3,931</b>	<b>3,426</b>	<b>3,231</b>	<b>3,417</b>

MARICOPA COUNTY JUVENILE COURT CENTER

**JUVENILES DETAINED  
On Delinquent Referrals**

Origination of Referral	1989	1990	1991	1992	1993
Avondale	22	43	30	31	23
Buckeye	12	7	11	12	6
Chandler	94	109	139	142	141
DPS (State)	43	51	47	52	48
El Mirage	19	22	26	23	26
Gilbert	24	23	30	26	38
Glendale	125	199	181	194	281
Goodyear	12	7	7	6	5
Guadalupe	19	7	0	0	0
MCSO (County)	73	104	96	89	100
Mesa	318	319	279	320	316
Paradise Valley	1	2	0	0	0
Peoria	25	38	57	59	54
Phoenix Police Dept.	1,666	2,304	2,157	2,018	2,127
Scottsdale	67	63	39	59	73
Surprise	8	7	13	6	5
Tempe	132	170	174	162	138
Tolleson	11	11	13	6	5
Wickenburg	8	10	1	3	5
Youngtown	0	1	0	0	0
Other Law Enforcement	6	8	23	6	11
<b>Sub Total</b>	<b>2,685</b>	<b>3,505</b>	<b>3,323</b>	<b>3,214</b>	<b>3,402</b>
Court	344	416	79	0	3
Parent	1	4	2	3	5
Probation Officer	28	5	21	11	6
School	0	0	1	0	0
Other Not Listed Elsewhere	2	1	0	3	1
<b>Sub Total</b>	<b>375</b>	<b>426</b>	<b>103</b>	<b>17</b>	<b>15</b>
<b>TOTAL</b>	<b>3,060</b>	<b>3,931</b>	<b>3,426</b>	<b>3,231</b>	<b>3,417</b>

# Field Probation

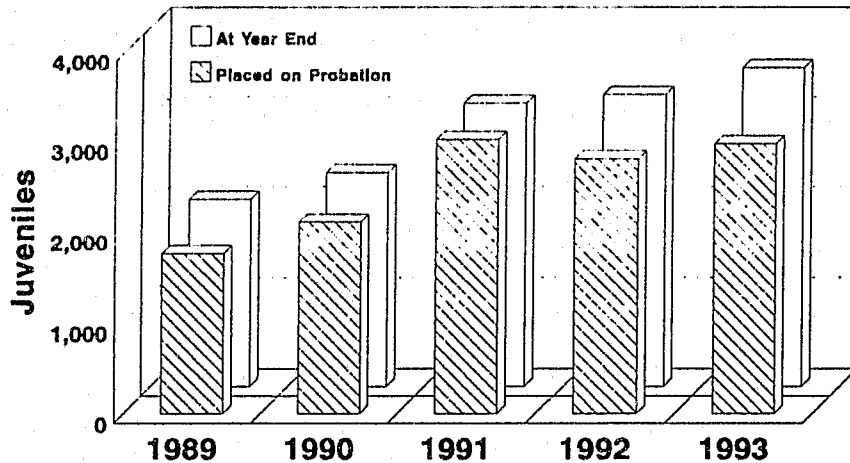

At Year End	2,062	2,352	3,127	3,222	3,526
Placed on Probation	1,761	2,104	3,022	2,807	2,976
Avg Mos. on Probation	14	14	13	13	15
Prior Referrals	1.4	1.8	1.8	1.8	1.7
PO Caseload	47	51	54	58	65

During 1993, 2,976 juveniles were placed on probation in the Field Division. The Field Probation Officer caseload has increased to a five year high of 65 cases under supervision. The average number of months a juvenile is on probation was 15 months, up from 13 months in 1992.

The average number of prior referrals a juvenile has when placed on probation has decreased slightly from 1992 of 1.8 referrals to 1.7 referrals in 1993.

## 1993

### Probationer Profile

Sex: Male (80%)

Age: 14 Years 6 Months

Ethnicity: Anglo (55%)

School Status: Attending (83%)

Severity: Grand Theft (38%)

Offense: Burglary (18%)

## MARICOPA COUNTY JUVENILE COURT CENTER

Assessments are imposed by the judiciary in cases allowed for probation service fees and placement service fees among others.

### Probation Fees Assessment and Collection

Probation assessments and collections in 1993 have increased by \$343,269 in assessments and \$123,112 in collections over 1992. Assessments increased significantly by 183% and collections increased 107% over 1992.

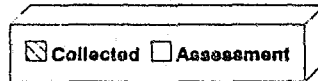
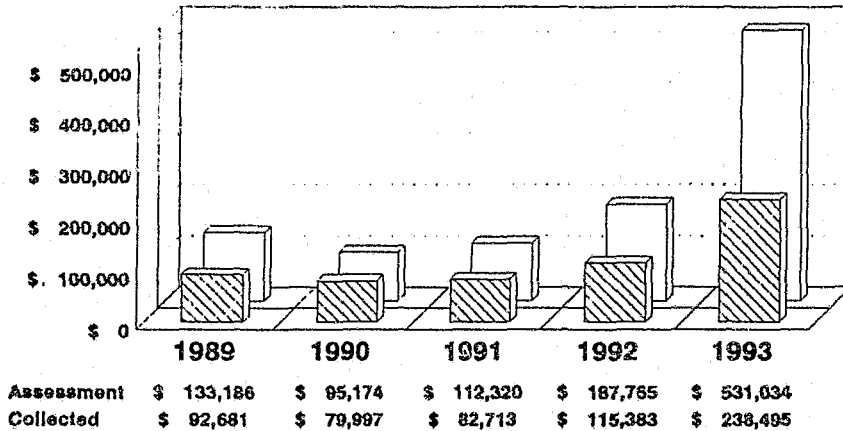

Placement assessments in 1993 have decreased 65% over 1992 by \$41,216.

Placement collections decreased by 50%, or \$22,953 over 1992.

### Placement Fees Assessment and Collection

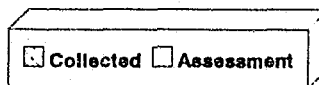
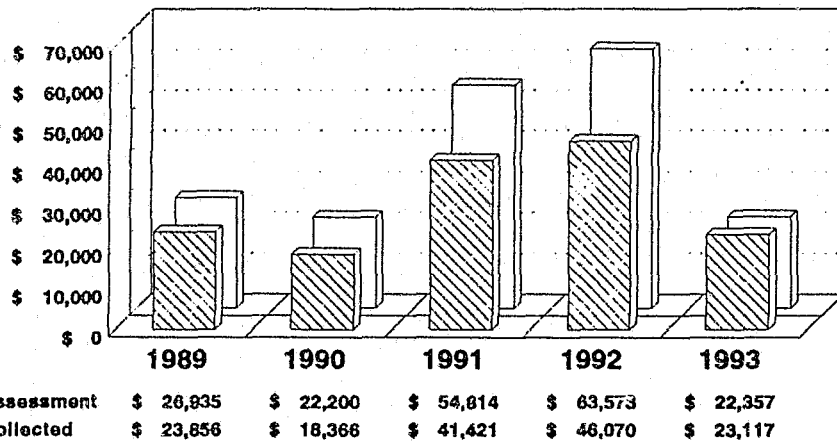

# Juveniles Committed or Awarded

## Arizona Department of Youth Treatment & Rehabilitation (ADYTR)

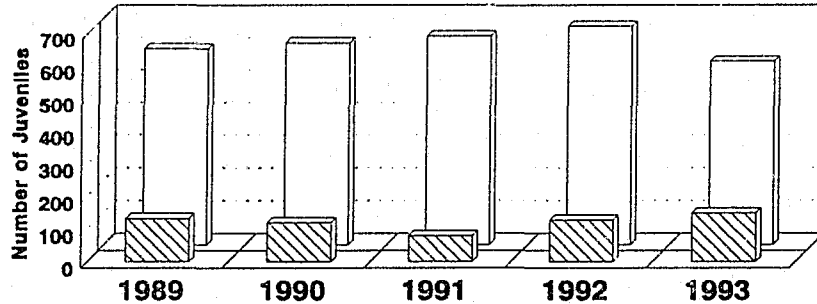

	1989	1990	1991	1992	1993
Committed	600	618	639	668	561
Awarded	132	120	80	127	149
Total to ADYTR	732	738	719	795	710
Avg Prior Referrals	4.4	4.9	5.4	6	6.3

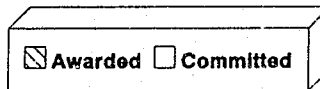

Commitments to the State Department of Youth Treatment & Rehabilitation (DYTR) has shown a decrease over 1992 of 107 juveniles committed to DYTR for a total of 561 juveniles in 1993. Juveniles awarded to DYTR increased by 22 from 1992 to 149 in 1993. The number of previous referrals prior to commitment have increased from 4.4 in 1989 to 6.3 in 1993.

### 1993

#### Committed Profile

- Sex: Male (85%)
- Age: 15 Years 2 Months
- Ethnicity: Minority (59%)
- School Status: Attending (65%)
- Severity: Obstructing (31%)
- Offense: Probation Viol. (30%)



# Juveniles Transferred to Adult Criminal Court

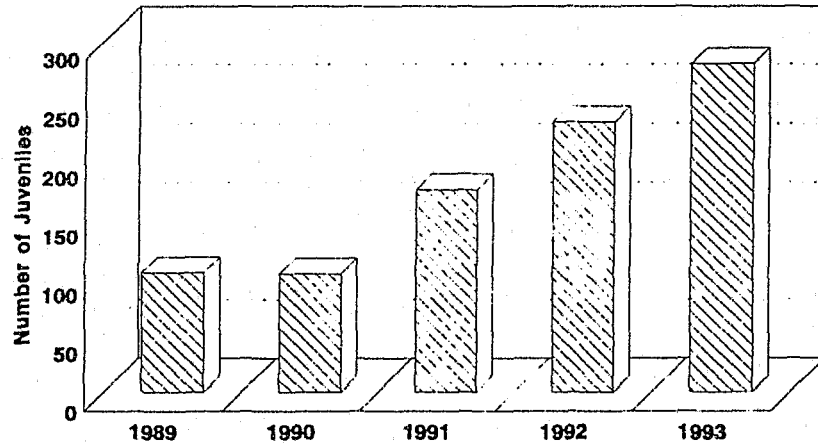

	1989	1990	1991	1992	1993
Transferred	102	101	173	231	280
Avg Prior Referrals	6.1	6.8	8.8	8.6	8.2

Originally in 1993 there were 281 juveniles transferred to Adult Court, one case was appealed.

A transfer hearing (or remand) is held on the motion of the County Attorney.

The Juvenile Court has the exclusive responsibility for making the decision to remand a juvenile for transfer for adult criminal prosecution.

The number of transfers to adult criminal court in 1993 increased by 21% over 1992 for a total of 280 juveniles being transferred. The number of prior complaints or referrals has decreased slightly from 8.8 in 1991 to 8.2 in 1993.

## 1993

### Transfer Profile

Sex: Male (94%)

Age: 16 Years 5 Months

Ethnicity: Minority (76%)

School Status: Not Attending (60%)

Severity: Violent (58%)

Offense: Agg. Assault (23%)

**MARICOPA COUNTY JUVENILE COURT CENTER**

**PROBATION, COMMITMENT, TRANSFER**

Severity of Referral 1993	Violent	Grand Theft	Obstr	Fight	Drugs	Peace	Theft	Status	Hold	TOTAL
Probation	519	1,206	28	218	275	251	351	201	29	3,078
Commitment	101	171	165	16	35	29	35	6	3	561
Transfer	180	78	2	1	17	1	1	0	0	280

Sex of Referred 1993	Probation	Commitment	Transfer
Female	626	83	18
Male	2,452	478	262
<b>TOTAL</b>	<b>3,078</b>	<b>561</b>	<b>280</b>

Ethnicity of Referred 1993	Probation	Commitment	Transfer
Anglo	1,676	229	68
Black	312	71	53
Hispanic	969	239	146
Indian	95	20	13
Other	26	2	0
<b>TOTAL</b>	<b>3,078</b>	<b>561</b>	<b>280</b>

## MARICOPA COUNTY JUVENILE COURT CENTER

Age at Referral 1993	Probation	Commitment	Transfer
8 Years	0	0	0
9 Years	7	0	0
10 Years	27	0	0
11 Years	57	0	0
12 Years	149	6	0
13 Years	339	44	0
14 Years	560	82	1
15 Years	688	139	20
16 Years	715	175	63
17 Years	536	115	196
<b>TOTAL</b>	<b>3,078</b>	<b>561</b>	<b>280</b>

Previous Legal Status of Referred 1993	Probation	Commitment	Transfer
None	2,859	73	78
Discharged from DYTR	7	5	31
Probation	3	459	34
Released from Probation	196	20	18
Committed to DYTR	5	1	111
Transferred from Other Jurisdiction	6	0	6
Unsuccessful Release	2	3	2
Ward of Other Agency	0	0	0
<b>TOTAL</b>	<b>3,078</b>	<b>561</b>	<b>280</b>

## Intake Caseload Cite-In First Set

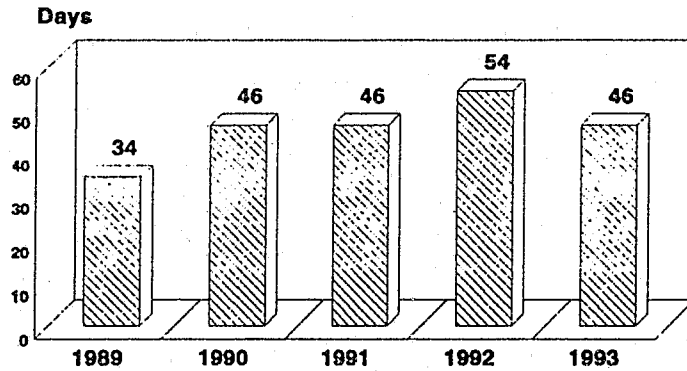

Average Number of Days from Complaint to Cite-In.

The intake cite-in is the interview of the referred juvenile and parent(s) at the Juvenile Court by an Intake Officer. Generally, these juveniles are first and second referral misdemeanors or status offenders. The Intake Officer has the discretion to handle the referral without initiating a formal court process.

The above graph shows the average number of days to first cite-in, measuring how quickly the Intake Division is able to get to the caseload assigned. In 1993, it took 46 days, the same as in 1990 and 1991. It took 54 days in 1992. A second measure is the number of pending (unfinished) cases is shown in the graph to the right. There were 3,956 pending cases in 1993, a 34% increase from 2,953 pending cases in 1992.

## Intake Caseload Cases Pending At Year End

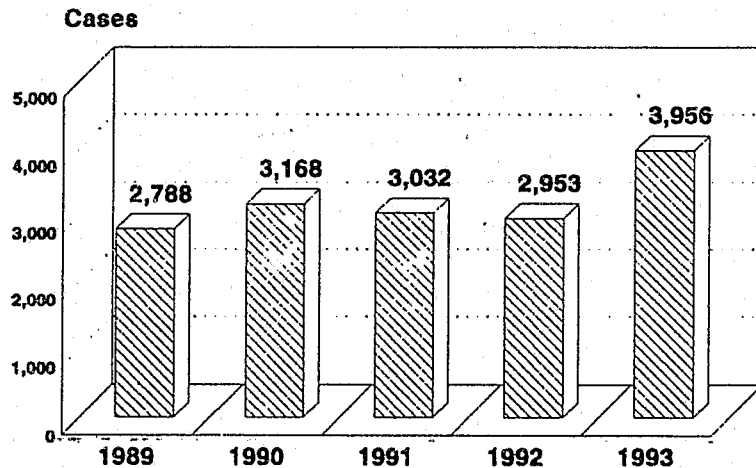

# Intake Caseload New Referrals Received

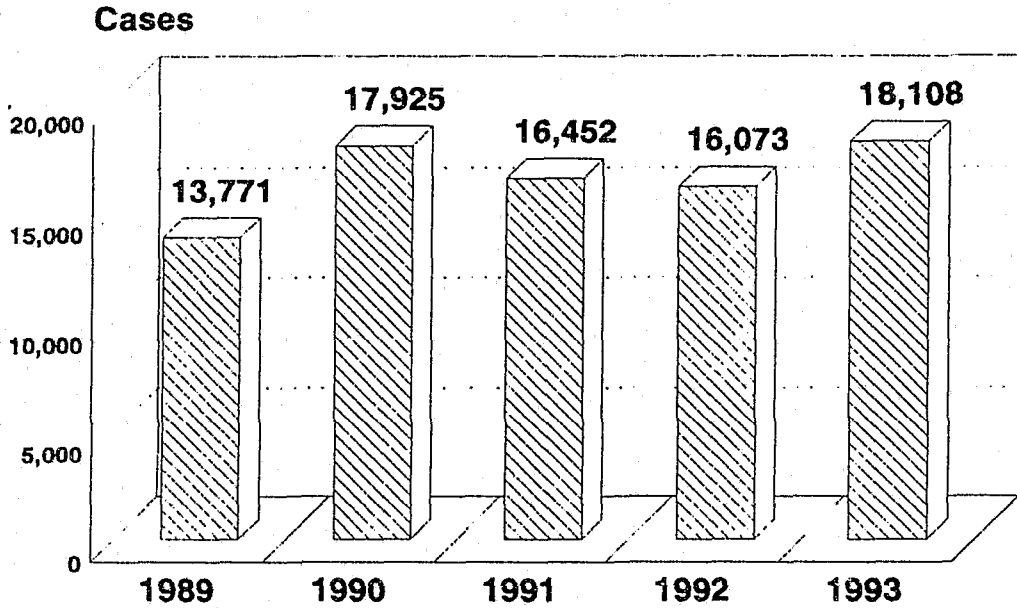

Referrals (complaints) where no formal petition is filed may be adjusted by the Intake Officer after the initial interview with the juvenile and parent(s). If the juvenile has acknowledged involvement in the alleged offense, the matter will not be adjusted until specific conditions established by the Probation Officer are met. Conditions of adjust may include referral to community agencies for family counseling, individual

counseling, specialized education, and awareness programs such as alcohol and drug abuse, restitution to victims, voluntary work hours in the community, and other similar options.

The number of New Referrals Received has shown an increase from 16,073 in 1992 to 18,108 New Referrals in 1993, a 32% increase in the last 5 years.

# PIC-ACT

## Assessment and Collection

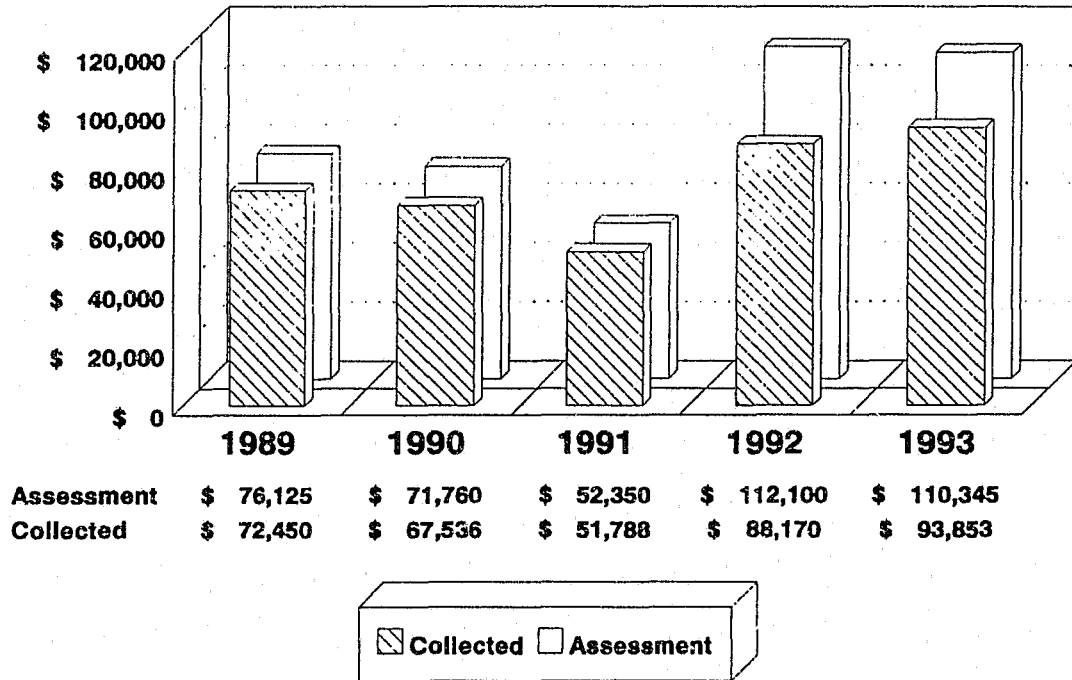

The Progressively Increasing Consequences Act (PIC-ACT) became effective through legislative action on July 1, 1984. If after conducting an intake interview with the alleged juvenile offender and parent(s), and the juvenile acknowledges responsibility for the delinquent act or alcohol offense, the Juvenile Probation Officer may adjust the delinquency complaint once the juvenile has complied with specific conditions.

Assessments made for Intake Services in 1993 have decreased 1.6% over 1992 to \$110,345, and collections have

increased 6.5% over 1992 to \$93,853 for 1993.

This legislation concentrates on first and second time offenders in hopes of eliminating future delinquent behavior patterns before they become firmly established. The development of PIC-ACT centers on the debate of whether holding youthful offenders more accountable for their delinquent behavior will result in a lower incidence of recidivism. Programs sponsored under PIC-ACT are currently in operation in all fifteen counties in Arizona.

# Home Detention

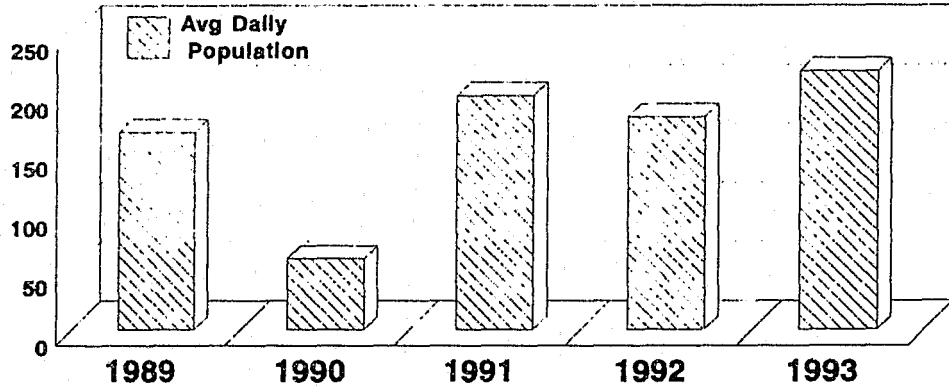

Juveniles Placed	1,234	1,608	1,667	1,640	1,839
Juveniles Released	1,171	1,596	1,700	1,618	1,796
Avg Daily Population	167	60	198	180	219
Avg Days in Home Detn	41.4	52.3	40.3	36.2	37.9

Home Detention is an alternative between structured institutional detention and unconditional release back into the community. Juveniles originally held in the juvenile detention facility, but being allowed to return home pending Court, may be assigned to Home Detention. In this program, the juvenile's freedom is greatly restricted and the Home Detention staff maintain frequent and close contact with the juvenile on an unannounced basis to assure

compliance with the conditions of release.

As compared to 1992, juveniles placed on Home Detention increased slightly from 1,640 to 1,839 in 1993. Juveniles released, also increased from 1,618 in 1992 to 1,796 in 1993. The average daily population in Home Detention is 219 juveniles with an average length of stay of 37.9 days in 1993.

# Placement

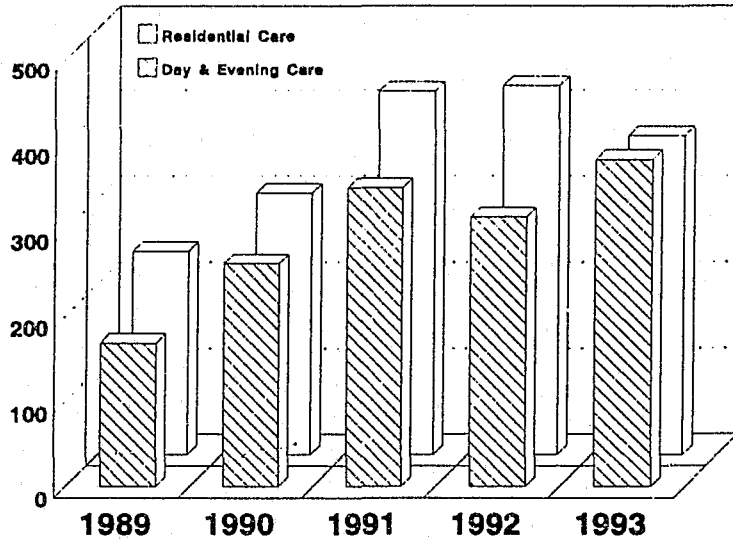

<b>Residential Care</b>	<b>237</b>	<b>305</b>	<b>423</b>	<b>430</b>	<b>371</b>
<b>Day &amp; Evening Care</b>	<b>168</b>	<b>260</b>	<b>348</b>	<b>314</b>	<b>381</b>

The number of juveniles in Placement during 1993 was 371 juveniles in Residential Care and 381 juveniles in Day and Evening Care.

Residential placement has increased by 57% from 1989 to 1993, with a peak of 430 juveniles in 1992. Day and Evening Care has increased 154% in the same 5 years.



# Diversion Programs

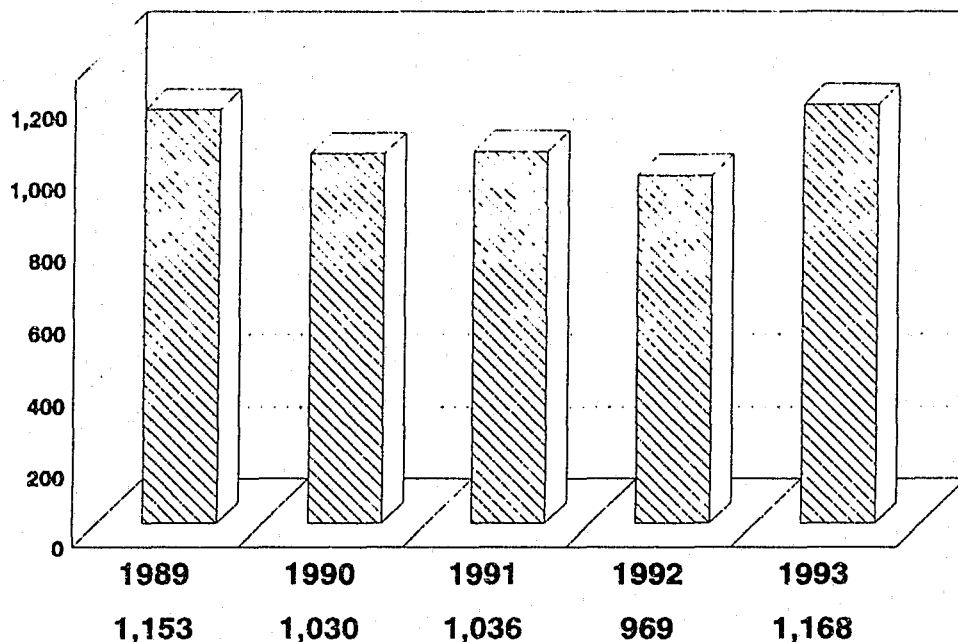

Diversion programs are established and supervised by various municipalities for the needs of some first time offenders in their communities. These programs are developed by agreement with the Court Center as provided by statute.

Several municipalities within Maricopa County have designed First Offender Programs to work with juveniles in the community.

Cities such as Phoenix, Mesa, Tempe, Glendale, Peoria, Scottsdale, Williams Air Force Base, Chandler, and Gilbert have various types of diversion programs for the first time offender.

The number of juveniles assigned to diversion programs in 1993 has not changed much from the number of juveniles assigned in 1989. 1992 had the lowest in the past 5 years with 969 juveniles.

## Recidivism Tracks a Juvenile for One Year After Referral

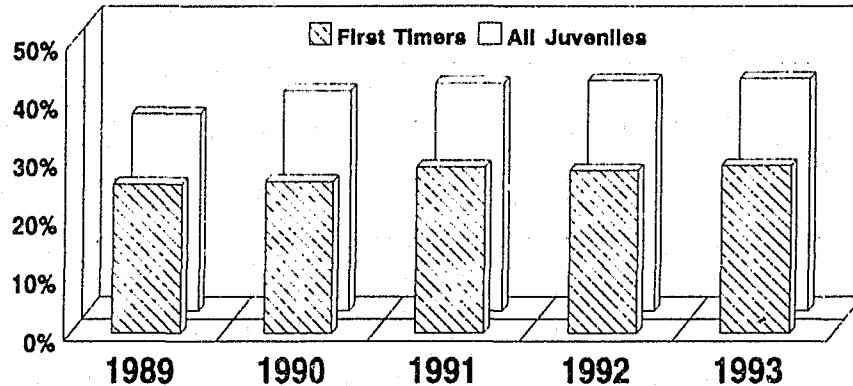

All Juveniles	33.9%	37.8%	39.1%	39.6%	39.9%
First Timers	25.5%	25.9%	28.4%	27.8%	28.7%

Excludes Juveniles who were 17 or older,  
Administrative Offenses, Probation Violation  
and Invalid Referrals.

In this table, recidivism is defined as the probability of a subsequent referral within one year of the initial referral, i.e., the probability of a subsequent arrest (guilt may not have been determined). Administrative offenses (Holds), and technical probation violations (i.e., no law violation charged) are not counted as initial referrals or subsequent referrals. Juveniles 17 years or older at the initial referral, are not considered. As soon as a juvenile reaches the age of 18, the Juvenile Court loses all jurisdiction over that person.

Two samples are used above. The sample called "First Timers" utilized only the first referral to Juvenile Court as the initial referral, while "All Juveniles" utilize any referral except an administrative offense or probation violation.

Juveniles recidivating has been gradually increasing over the past five years. In 1993, approximately 29% of all First Time Offenders recidivate, and approximately 40% of All Juveniles recidivate.

# 1993 Petitions Filed

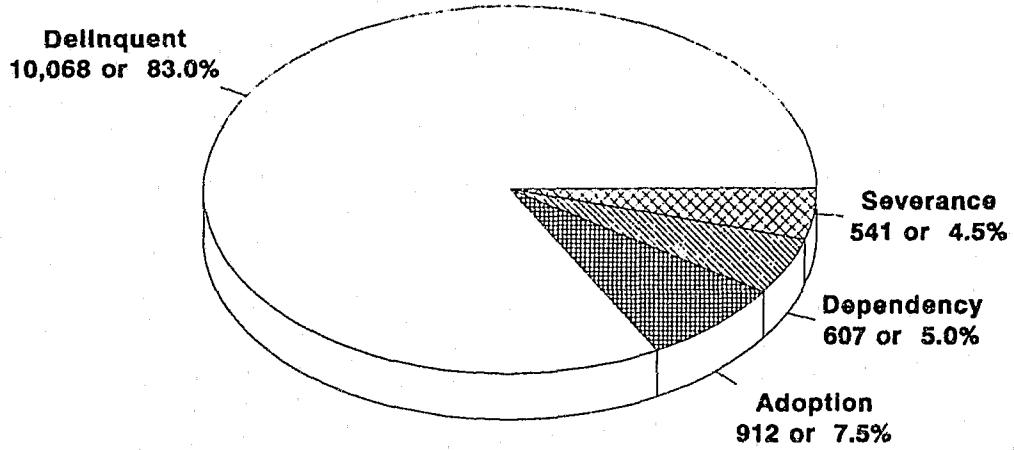

Petitions Filed	1989	1990	1991	1992	1993
Adoption	848	803	967	913	912
Dependency	622	532	491	529	607
Severance	605	558	557	543	541
Delinquency	7,033	8,031	9,126	9,360	10,068
<b>TOTAL</b>	<b>9,108</b>	<b>9,924</b>	<b>11,141</b>	<b>11,345</b>	<b>12,128</b>

# 1993 Court Hearings Summary

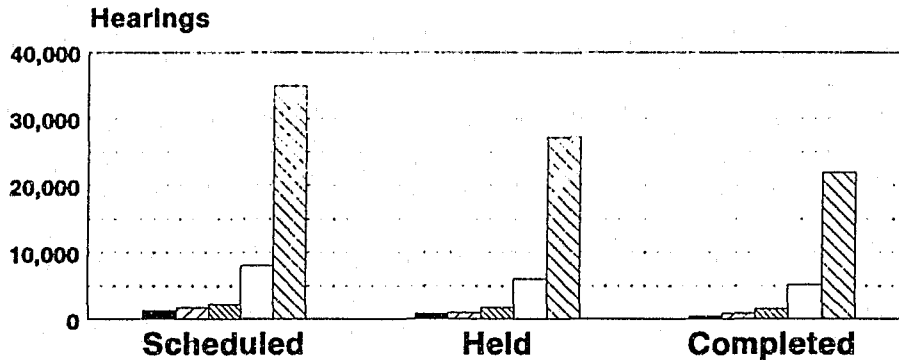

Severence	1,356	849	492
Adoption	1,768	951	847
Miscellaneous	2,191	1,715	1,510
Dependency	8,042	6,067	5,111
Delinquency	34,896	27,162	21,943

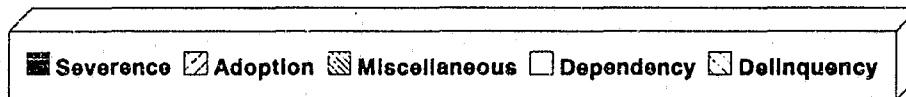

A Scheduled hearing is set before a particular judicial officer on a particular day and time, though for many hearings (advisories for instance) several may be "stacked" at the same time. A hearing categorized as Held, is one with a recorded start and end time. A Completed hearing is one showing a result of completed, under advisement, or conditional

(applying to dispositions).

In 1993, a total of 48,253 hearings were scheduled, 36,744 hearings were held, and 29,903 hearings were completed. Approximately 72% of these hearings were for delinquency matters.

**MARICOPA COUNTY JUVENILE COURT CENTER**

<b>Court Hearings Scheduled</b>	<b>1989</b>	<b>1990</b>	<b>1991</b>	<b>1992</b>	<b>1993</b>
<b>Adoption</b>	<b>1,179</b>	<b>1,757</b>	<b>1,199</b>	<b>1,375</b>	<b>1,768</b>
<b>Dependency</b>	<b>7,408</b>	<b>7,386</b>	<b>8,198</b>	<b>7,735</b>	<b>8,042</b>
<b>Severance</b>	<b>1,329</b>	<b>1,417</b>	<b>1,745</b>	<b>1,229</b>	<b>1,356</b>
<b>Delinquency</b>	<b>24,220</b>	<b>31,460</b>	<b>38,361</b>	<b>33,720</b>	<b>34,896</b>
<b>Miscellaneous</b>	<b>1,512</b>	<b>1,826</b>	<b>1,932</b>	<b>1,978</b>	<b>2,191</b>
<b>TOTAL</b>	<b>35,648</b>	<b>43,846</b>	<b>51,435</b>	<b>46,037</b>	<b>48,253</b>

**Total scheduled court hearings have increased 35% since 1989, from 35,648 hearings to 48,253 scheduled hearings in 1993.**

**There has been major increase in Delinquency hearings which increased 44% in the last 5 years.**

**Hearing types were re-adjusted in 1993 to re-classify the Miscellaneous category. Hearings for the years 1989 to 1993 were re-calculated as a result of this adjustment. Actual Total Hearings Scheduled did not vary significantly from the numbers previously published, but Miscellaneous and Delinquency Hearings were re-defined which did effect their total.**

MARICOPA COUNTY JUVENILE COURT CENTER

Disposition of Referrals  
1989-1993

NON-COURT DISPOSITIONS

		1989	1990	1991	1992	1993
Administrative	Invalid	66	114	97	88	30
	Withdrawn	8	10	14	12	6
	Non-Complaint Completed	0	0	0	2	7
	Unresolved (Loss of Jurisdiction)	849	817	923	880	776
	Missing Data	2	4	2	0	0
	Released (Traffic or Delinquency Warrant)	888	1,032	271	18	10
Record Only	Not Referred	0	0	2	2	0
	Victim Refuses Prosecution	46	46	43	60	47
	Referred - DYTR (Dept. of Youth Treatment & Rehabilitation)	158	267	495	245	57
	Referred - Dept. of Economic Security	7	9	7	9	5
	Referred - Diversion Program	1,153	1,030	1,036	969	1,168
	Referred - Other Jurisdiction	136	151	131	145	189
	Referred - Police Agency	986	1,003	923	731	720
	Referred - Other Agency	2	0	1	2	3
	County Attorney Choose Not To File	0	0	108	1,269	1,375
	Interviewed	Adjusted	592	901	1,854	1,869
Adjusted - Conditional		5,468	5,009	5,313	5,093	4,489
Adjusted - Counsel & Warn		12	17	12	24	7
Adjusted - Not Filed by County Attorney		2,459	3,107	2,690	1,719	1,248
Adjusted - From Other Jurisdiction		318	291	254	211	242
<b>TOTAL</b>	<b>NON-COURT DISPOSITIONS</b>	<b>13,148</b>	<b>14,498</b>	<b>14,176</b>	<b>13,348</b>	<b>12,168</b>

**MARICOPA COUNTY JUVENILE COURT CENTER**

**Disposition of Referrals  
1989-1993**

		1989	1990	1991	1992	1993
Traffic	Guilty	1,586	1,889	1,556	1,703	3,333
	Not Guilty	690	774	850	949	1,004
<b>TOTAL</b>	<b>TRAFFIC COURT DISPOSITIONS</b>	<b>2,276</b>	<b>2,663</b>	<b>2,406</b>	<b>2,652</b>	<b>4,337</b>

**COURT DISPOSITIONS**

		1989	1990	1991	1992	1993
Dismissed		1,566	2,225	2,546	2,308	2,185
Terminate & Close		144	127	80	96	97
Penalty	Penalty	410	629	639	402	310
	Penalty Terminate & Close	271	213	143	17	14
Judicial Adjustment		1	1	0	1	1
Probation	Probation	1,511	1,827	2,532	2,376	2,592
	Probation with Restitution	249	336	557	502	492
	Continued Probation	494	572	892	1,231	1,284
	Continued Probation - Restitution	41	68	157	184	162
DYTR	Committed - DYTR (Dept. Youth Treatment & Rehabilitation)	600	618	639	668	561
	Awarded - DYTR	132	120	80	127	149
Transferred	To Other Agency	59	50	58	64	73
Remanded	To Adult Court	102	101	173	231	280
Court	Other	1	0	0	2	1
<b>TOTAL</b>	<b>COURT DISPOSITIONS</b>	<b>5,581</b>	<b>6,887</b>	<b>8,496</b>	<b>8,209</b>	<b>8,201</b>

MARICOPA COUNTY JUVENILE COURT CENTER

**Appendix A**  
**Zipcode of Residence**  
**1993 Referrals**

Zipcode of Referral	Violent	Grand Theft	Obstr	Fight	Drugs	Peace	Theft	Status	Hold	TOTAL
85001	0	1	0	1	1	3	0	1	0	7
85002	0	1	0	0	0	0	0	0	0	1
85003	18	29	24	8	10	16	18	70	0	193
85004	7	14	5	4	3	8	7	36	0	84
85005	0	1	0	0	0	0	0	0	0	1
85006	76	150	56	39	55	73	76	254	2	781
85007	41	73	34	29	33	45	50	150	1	456
85008	45	157	53	41	39	52	165	224	6	762
85009	76	226	78	70	77	85	209	510	7	1,338
85010	0	0	0	0	0	0	0	2	0	2
85011	0	0	0	1	0	0	0	0	0	1
85012	2	7	4	4	2	3	7	19	0	48
85013	14	32	14	21	5	13	56	61	1	217
85014	18	61	16	24	9	14	61	114	1	318
85015	28	78	26	37	15	35	129	179	3	530
85016	16	78	27	20	16	20	67	128	3	375
85017	24	81	30	40	22	37	94	143	4	475
85018	8	45	8	11	14	20	46	92	3	247
85019	33	62	32	20	23	39	78	110	0	397
85020	19	64	22	21	11	18	82	177	2	416
85021	23	43	21	26	9	19	66	150	1	358
85022	13	50	10	22	14	31	65	176	0	381
85023	36	78	48	48	29	43	130	236	4	652
85024	4	34	12	14	8	12	40	84	1	209
85025	0	0	0	0	0	0	1	0	0	1
85027	26	85	27	21	24	40	75	159	2	459
85028	2	25	10	9	9	21	40	135	0	251
85029	27	74	42	48	15	39	107	214	2	568
85031	44	91	33	28	30	38	99	196	4	563
85032	36	104	48	71	58	76	184	452	1	1,030
85033	72	132	90	69	49	78	198	465	1	1,154
85034	30	71	17	15	18	25	28	130	1	335



## MARICOPA COUNTY JUVENILE COURT CENTER

Zipcode of Referral	Violent	Grand Theft	Obstr	Fight	Drugs	Peace	Theft	Status	Hold	TOTAL
85035	71	106	47	53	61	67	193	453	2	1,053
85036	0	2	0	0	1	0	0	4	0	7
85037	15	44	21	21	15	22	83	134	1	356
85038	0	0	0	0	0	0	1	0	0	1
85039	2	12	3	3	4	6	12	17	0	59
85040	132	208	83	86	65	137	215	406	5	1,337
85041	68	119	58	42	28	52	107	296	1	771
85043	11	17	7	13	7	12	36	61	2	166
85044	13	35	14	17	17	20	67	56	1	240
85046	0	0	0	0	1	0	0	0	0	1
85048	1	5	0	0	1	0	1	1	0	9
85051	15	41	52	57	17	34	86	156	2	460
85053	0	0	0	0	0	1	0	0	0	1
85060	0	0	0	0	0	0	0	1	0	1
85061	0	0	0	0	0	0	1	0	0	1
85066	0	0	0	0	0	0	1	0	0	1
85067	0	0	1	1	0	1	0	0	0	3
85068	0	1	0	0	0	0	0	0	0	1
85069	0	0	0	0	0	0	1	0	0	1
85071	1	0	0	0	0	4	1	1	0	7
85074	0	1	0	0	0	0	0	0	0	1
85075	0	0	0	0	0	0	0	1	0	1
85078	0	0	0	0	0	0	1	0	0	1
85080	0	1	0	0	0	0	0	0	0	1
85120	0	0	0	0	0	0	0	1	0	1
85201	39	133	33	60	30	94	155	115	6	665
85202	25	58	23	47	43	65	74	93	3	431
85203	22	77	23	34	21	64	118	65	0	424
85204	46	130	65	76	50	102	197	168	3	837
85205	18	73	13	26	13	46	86	49	2	326
85206	8	19	6	13	7	16	36	21	0	126
85207	5	53	16	13	16	13	61	24	1	202
85208	10	41	15	16	12	23	38	35	4	194
85210	30	62	47	40	25	64	109	105	0	482
85211	0	0	0	1	0	1	1	3	0	6

## MARICOPA COUNTY JUVENILE COURT CENTER

Zipcode of Referral	Violent	Grand Theft	Obstr	Fight	Drugs	Peace	Theft	Status	Hold	TOTAL
85213	14	31	8	16	10	16	45	26	0	166
85215	0	0	0	2	0	0	0	1	0	3
85217	0	0	0	0	0	0	1	2	0	3
85218	0	0	0	0	0	0	0	1	0	1
85219	1	16	0	0	3	3	18	1	0	42
85220	4	40	9	4	10	14	31	10	1	123
85221	3	5	2	0	0	2	6	1	0	19
85222	0	6	0	2	2	1	14	5	0	30
85223	0	1	0	1	0	0	3	1	0	6
85224	57	164	72	102	79	141	193	426	5	1,239
85225	32	63	39	34	44	60	63	252	1	588
85226	7	31	15	14	16	42	34	75	0	234
85227	0	1	1	2	0	2	0	0	0	6
85228	0	2	0	0	0	1	3	1	0	7
85229	0	0	0	0	0	0	0	1	0	1
85230	0	0	0	0	0	0	1	0	0	1
85231	0	1	0	0	0	0	3	1	0	5
85232	0	0	0	0	0	0	2	0	0	2
85233	2	1	0	1	1	2	1	10	0	18
85234	18	96	27	42	28	40	106	199	0	556
85236	3	10	3	2	1	2	12	8	0	41
85237	0	0	0	0	1	0	0	0	0	1
85239	0	1	0	1	1	1	1	0	1	6
85240	0	0	0	0	0	0	1	0	0	1
85242	2	5	1	6	6	10	9	8	0	47
85244	0	2	0	1	0	1	1	3	0	8
85247	0	7	3	0	2	4	5	4	0	25
85248	2	5	6	1	1	4	3	8	0	30
85249	1	5	2	1	3	4	3	10	0	29
85250	6	10	7	15	9	10	14	28	0	99
85251	12	40	14	19	14	30	50	67	1	247
85252	1	0	0	1	1	0	3	2	0	8
85253	5	14	4	2	8	5	14	26	0	78
85254	12	53	11	11	17	31	79	167	0	381
85255	0	2	0	1	2	3	5	9	0	22

MARICOPA COUNTY JUVENILE COURT CENTER

Zipcode of Referral	Violent	Grand Theft	Obstr	Fight	Drugs	Peace	Theft	Status	Hold	TOTAL
85256	4	9	3	3	9	5	33	13	0	79
85257	7	23	22	33	12	42	52	60	1	252
85258	6	10	3	6	8	15	26	29	0	103
85259	5	9	7	6	4	5	14	15	0	65
85260	9	20	5	6	8	14	34	37	0	133
85262	0	0	1	0	0	0	0	1	0	2
85264	0	0	0	5	1	2	2	0	0	10
85268	8	13	2	8	7	5	20	6	1	70
85269	2	1	0	1	3	0	1	3	0	11
85271	0	1	0	1	1	3	3	1	0	10
85272	0	1	0	0		0	0	0	0	1
85273	0	0	0	0	0	0	1	0	0	1
85281	35	79	27	60	23	74	121	146	1	566
85282	26	82	25	26	23	45	130	162	0	519
85283	35	74	28	34	33	69	123	196	0	592
85284	1	13	4	6	4	11	20	36	2	99
85285	0	0	0	0	0	0	1	0	0	1
85288	0	0	0	0	0	0	0	1	0	1
85291	0	0	0	0	0	0	1	0	0	1
85292	0	0	0	0	2	1	0	0	0	3
85296	1	0	0	0	1	0	2	0	0	4
85301	98	143	109	140	43	115	223	267	1	1,139
85302	21	42	16	40	16	26	58	79	0	298
85303	15	26	16	12	11	23	56	41	1	201
85304	18	37	14	34	22	35	73	54	2	289
85305	1	4	1	2	3	2	7	9	0	29
85306	21	35	17	30	13	26	73	63	0	278
85307	3	4	3	3	2	4	3	7	0	29
85308	24	44	19	32	27	50	50	67	1	314
85310	0	16	1	5	1	5	12	11	1	52
85311	0	2	0	0	0	1	0	1	0	4
85314	0	0	0	0	0	0	0	1	0	1
85318	0	0	0	0	0	0	0	4	0	4
85320	0	4	0	0	0	0	1	0	0	5
85321	1	0	0	0	0	0	0	2	0	3

**MARICOPA COUNTY JUVENILE COURT CENTER**

<b>Zipcode of Referral</b>	<b>Violent</b>	<b>Grand Theft</b>	<b>Obstr</b>	<b>Fight</b>	<b>Drugs</b>	<b>Peace</b>	<b>Theft</b>	<b>Status</b>	<b>Hold</b>	<b>TOTAL</b>
85323	34	74	23	33	24	46	68	118	0	420
85324	0	0	0	0	0	0	1	2	0	3
85326	12	35	9	9	10	20	31	53	1	180
85329	5	14	2	9	1	8	10	17	0	66
85330	0	0	0	0	0	0	1	0	0	1
85331	1	3	7	4	4	10	18	29	0	76
85332	0	0	0	1	0	0	2	1	0	4
85334	0	0	0	0	0	1	0	1	0	2
85335	24	31	14	20	24	20	26	45	1	205
85336	0	0	0	0	0	0	0	2	0	2
85337	3	13	2	7	1	3	2	18	0	49
85338	3	8	4	7	3	5	16	17	1	64
85339	4	18	5	3	5	0	11	23	0	69
85340	5	0	3	4	1	2	7	7	0	29
85342	0	0	2	1	0	0	3	0	0	6
85343	1	0	0	0	0	1	1	0	0	3
85344	0	1	0	0	0	0	0	2	0	3
85345	39	80	40	46	33	58	142	94	5	537
85347	0	0	0	0	0	1	0	0	0	1
85349	0	0	0	0	0	0	0	2	0	2
85350	1	0	0	0	0	0	0	0	0	1
85351	0	0	0	1	0	0	0	1	1	3
85353	11	14	7	7	3	9	37	46	0	134
85354	0	2	0	0	0	1	1	2	0	6
85355	1	3	0	1	3	0	4	4	0	16
85356	0	0	0	0	0	0	1	0	0	1
85358	0	2	3	6	0	6	13	9	2	41
85361	4	8	1	3	1	9	15	12	0	53
85363	0	1	1	0	0	0	0	1	0	3
85364	1	1	0	1	0	1	0	4	1	9
85373	1	3	1	0	1	3	0	1	0	10
85374	6	25	5	12	3	15	18	21	0	105
85377	0	0	1	0	0	1	4	9	0	15
85380	0	0	0	0	0	0	1	1	0	2
85381	2	6	0	6	8	8	14	7	0	51

## MARICOPA COUNTY JUVENILE COURT CENTER

Zipcode of Referral	Violent	Grand Theft	Obstr	Fight	Drugs	Peace	Theft	Status	Hold	TOTAL
85382	8	3	2	2	0	5	10	5	1	36
85384	0	0	0	0	0	0	0	1	0	1
85390	0	2	0	0	0	3	2	2	0	9
85430	0	0	0	0	0	0	0	1	0	1
85501	0	0	0	0	0	0	0	1	0	1
85502	0	1	0	0	0	0	1	0	0	2
85530	0	0	0	0	0	0	1	0	0	1
85532	0	0	0	0	0	0	1	0	0	1
85534	0	1	0	0	0	0	0	0	0	1
85540	0	1	0	0	0	0	0	0	0	1
85541	0	0	2	0	0	1	2	1	0	6
85544	0	0	0	0	0	0	3	0	0	3
85546	0	0	0	0	0	1	1	1	0	3
85547	0	0	0	0	0	0	2	1	0	3
85548	0	0	0	0	0	0	1	0	0	1
85550	0	0	0	0	0	0	2	0	0	2
85551	0	1	0	0	1	0	0	0	0	2
85552	0	0	0	0	0	0	2	2	0	4
85607	0	2	0	0	1	0	0	0	0	3
85614	0	0	0	0	0	0	1	0	0	1
85621	0	1	0	1	0	0	0	0	0	2
85631	0	2	0	0	0	0	0	0	0	2
85634	0	0	0	0	0	0	1	1	0	2
85635	3	0	0	0	0	0	3	2	1	9
85636	0	0	0	0	0	0	1	0	0	1
85636	0	0	0	0	0	0	0	1	0	1
85653	0	0	0	0	0	0	0	3	0	3
85701	0	0	0	0	0	0	0	1	0	1
85704	0	0	0	0	0	1	0	1	0	2
85705	0	1	0	0	1	0	2	3	0	7
85706	1	0	0	0	0	1	0	1	0	3
85710	0	2	1	0	0	0	2	1	0	6
85711	0	0	0	0	1	0	3	1	0	5
85712	0	0	0	0	1	0	0	0	1	2
85713	0	4	0	0	1	1	0	1	0	7

## MARICOPA COUNTY JUVENILE COURT CENTER

Zipcode of Referral	Violent	Grand Theft	Obstr	Fight	Drugs	Peace	Theft	Status	Hold	TOTAL
85714	0	1	0	0	0	0	0	1	0	2
85715	0	0	0	0	1	0	0	0	0	1
85716	0	0	0	1	0	0	1	0	0	2
85730	0	0	0	0	1	1	0	0	0	2
85737	1	0	0	0	0	0	0	1	0	2
85741	1	0	0	0	0	0	0	2	0	3
85743	0	0	0	0	0	0	0	3	0	3
85745	0	0	0	0	0	0	2	2	0	4
85746	0	0	0	0	1	2	1	0	1	5
85763	0	0	0	0	0	0	0	1	0	1
85901	0	0	0	0	0	0	2	1	1	4
85921	0	1	0	0	0	0	0	0	0	1
85925	0	0	0	0	0	0	0	1	0	1
85928	1	1	0	0	0	0	0	1	0	3
85929	0	0	0	0	0	0	1	1	0	2
85936	0	0	0	0	0	0	1	0	0	1
85938	0	0	0	0	0	0	0	0	1	1
Other	28	113	32	24	49	60	136	272	9	723
Unk.	0	1	0	0	0	0	0	2	0	3
<b>Total</b>	<b>1,994</b>	<b>4,969</b>	<b>2,028</b>	<b>2,366</b>	<b>1,751</b>	<b>3,058</b>	<b>6,355</b>	<b>10,466</b>	<b>130</b>	<b>33,117</b>

MARICOPA COUNTY JUVENILE COURT CENTER

**Appendix B**  
**Actual School of Referred by School District**  
**1993 Referrals**

Actual Schools 1993 By School Districts	Violent	Grand Theft	Obstruct	Fight	Drugs	Peace	Theft	Status	Hold	TOTAL
Agua Fria High	6	16	7	10	6	25	14	24	0	108
Agua Fria Union	14	13	6	8	8	11	9	27	0	96
School District: Agua Fria Union	20	29	13	18	14	36	23	51	0	204
Aquila	0	4	0	0	0	0	0	0	0	4
School District: Aquila Elementary	0	4	0	0	0	0	0	0	0	4
Alhambra Traditional	0	0	0	1	0	0	1	0	0	2
Andalucia	5	23	3	9	1	3	21	14	0	79
Barcelona	7	13	4	18	3	6	19	16	0	86
Catalina	7	8	4	9	2	7	16	9	0	62
Cordova	2	13	3	10	0	2	17	11	1	59
Grenada East	4	7	3	3	2	7	9	19	1	55
Grenada Primary	0	4	0	0	0	1	1	0	0	6
Sevilla	0	5	1	1	0	0	2	4	0	13
Simpson	3	8	1	10	3	9	19	26	0	79
Westwood	1	2	4	1	1	1	1	4	0	15
School District: Alhambra Elementary	29	63	23	62	12	36	106	103	2	456
Arlington	0	0	0	0	0	1	0	0	0	1
School District: Arlington Elementary	0	0	0	0	0	1	0	0	0	1,329
Avondale Elementary	1	0	0	1	0	0	0	0	0	2
Avondale Jr High	7	8	0	10	1	8	32	18	0	84
Coor	5	8	2	6	4	4	10	14	0	53
Pioneer	0	3	2	0	0	0	2	2	0	9
School District: Avondale Elementary	13	19	4	17	5	12	44	34	0	146
Balsz	1	3	0	3	0	3	7	6	0	20
Crockett	2	6	1	1	1	2	4	12	0	29
Griffith	2	4	0	0	0	2	5	6	0	19
Orangedale	1	5	1	3	0	0	5	6	0	21
School District: Baltz Elementary	6	18	2	4	1	7	21	30	0	89
Buckeye	1	12	1	1	2	0	12	11	0	40
School District: Buckeye Elementary	1	12	1	1	2	0	12	11	0	40
Buckeye Union High	10	24	9	4	7	16	18	35	0	123
School District: Buckeye Union	10	24	9	4	7	16	18	35	0	123
Borman	10	39	15	11	15	14	37	76	0	217
Byron	0	2	0	0	0	0	0	1	0	3
Cartwright	0	2	2	0	0	0	4	9	0	17
Desert Sands Jr High	18	32	7	17	12	22	50	60	0	218
Downs	1	0	0	1	0	0	8	1	0	9
Estrella Jr High	7	29	18	22	6	10	46	113	0	251
Harris	0	0	0	0	1	0	1	0	0	2
Heatherbra	1	1	1	0	1	0	5	7	0	16
Holiday Park	0	3	0	0	0	2	4	1	0	10
Long	0	2	2	0	0	0	5	5	0	14
Palm Lane	0	6	3	0	1	0	12	4	0	26
Palm Lane North	1	0	0	0	0	0	0	0	0	1
Peralta	2	3	2	1	0	1	5	7	0	21
Powell	0	0	0	0	0	0	0	0	0	0
Spitalny	0	1	0	1	0	1	8	3	0	14

## MARICOPA COUNTY JUVENILE COURT CENTER

Actual Schools 1993 By School Districts	Violent	Grand Theft	Obstruct	Fight	Drugs	Peace	Theft	Status	Hold	TOTAL
Starlight Park	3	6	1	1	0	0	11	13	0	35
Sunset	0	0	2	0	1	0	3	2	0	6
Tomahawk	0	3	0	0	0	1	0	4	0	8
School District: Cartwright Elementary	43	129	53	54	37	51	197	306	0	670
Black Mountain	0	0	0	0	0	0	1	0	0	1
Cactus Shadows H S	0	2	4	3	3	6	15	33	0	66
Cactus Shadows Middle	0	0	0	0	0	0	0	0	0	0
Desert Arroyo Middle	1	0	1	0	0	4	4	1	0	11
School District: Cave Creek Unified	1	2	5	3	3	10	20	34	0	78
Anderson Jr High	12	18	9	23	14	19	27	73	0	195
Bogle Jr High	4	23	10	8	5	9	21	38	0	118
Chandler Jr High	0	0	0	0	0	0	0	1	0	1
Chandler H S	15	31	19	19	21	43	45	86	0	279
Erie	0	3	0	0	0	4	4	1	0	12
Fry	0	2	2	0	0	1	2	0	0	7
Galveston	3	0	4	4	1	0	8	15	0	35
Goodman	0	1	0	0	0	0	0	0	0	1
Hartford	0	1	0	2	1	1	3	1	0	9
Humphrey	0	0	0	0	0	0	1	0	0	1
Jacobson	1	2	1	0	1	0	0	2	0	7
Knox	0	4	0	3	2	2	8	4	0	23
San Marcos	2	1	1	0	1	3	3	20	0	31
Shumway	0	0	0	1	0	0	1	2	0	4
Weinberg	2	0	0	0	0	0	1	0	0	3
Willis Jr High	10	30	18	21	18	26	13	134	0	270
School District: Chandler Unified	49	116	64	81	64	108	137	377	0	996
Creighton	19	58	25	16	20	15	60	100	0	313
Kennedy	0	8	0	0	0	0	0	7	0	15
Loma Linda	2	1	1	4	0	0	1	2	0	11
Machan	1	7	2	0	1	1	1	4	0	17
Monte Vista	0	1	0	4	1	0	5	7	0	18
Papago	0	4	1	2	2	2	6	10	0	27
Squaw Peak	1	1	0	1	0	0	6	9	0	18
School District: Creighton Elementary	23	60	29	27	24	18	79	139	0	419
Arrowhead	0	1	0	0	0	0	1	1	0	3
Bellair	0	0	0	1	0	1	2	0	0	4
Constitution	0	0	0	1	0	1	6	2	0	10
Deer Valley H S	14	46	15	29	20	45	44	56	0	269
Deer Valley Jr High	13	23	9	10	4	11	29	67	1	167
Deer Valley Vocational	0	1	1	2	0	0	0	5	0	9
Desert Sage	0	0	0	0	0	0	1	0	0	1
Desert Sky Middle	6	10	3	7	4	8	12	19	1	70
Desert Winds	2	1	0	0	0	0	0	0	0	3
Esperanza	0	0	0	1	0	1	2	1	0	5
Goldwater H S	14	66	29	21	19	29	67	95	0	340
Greenbrier	0	0	1	0	0	0	0	0	0	1
Hillcrest Jr High	3	15	5	9	7	5	9	10	0	63
Mirage	1	1	0	0	0	0	2	0	0	4
New River	0	2	0	0	0	1	0	0	0	3
Park Meadows	0	0	0	0	1	0	2	1	0	4
Sunrise	1	3	1	3	0	0	4	5	0	17
Village Meadows	0	0	1	0	0	0	5	4	1	11
School District: Deer Valley Unified	54	169	65	84	55	102	186	266	3	964
Dysart Elementary & Jr H	3	28	3	5	11	11	18	16	0	95
Dysart H S	21	23	9	17	7	18	20	25	1	141
El Mirage	2	0	1	0	5	1	2	0	0	11



## MARICOPA COUNTY JUVENILE COURT CENTER

Actual Schools 1993 By School Districts	Violent	Grand Theft	Obstruct	Fight	Drugs	Peace	Theft	Status	Hold	TOTAL
Kingswood	0	0	0	0	0	1	3	0	0	4
Surprise	2	5	0	0	1	3	0	5	0	16
School District: Dysart Unified	28	56	13	22	24	34	43	46	1	267
Four Peaks	0	1	0	1	0	2	4	0	0	8
Fountain Hills Jr/Sr H S	8	11	0	10	7	3	19	5	1	64
McDowell Mountain	0	0	0	0	0	0	0	0	0	0
School District: Fountain Hills Unified	8	12	0	11	7	5	23	5	1	72
Fowler	2	2	1	3	3	4	15	11	0	41
Sunridge	0	0	0	0	0	0	0	0	0	0
School District: Fowler Elementary	2	2	1	3	3	4	15	11	0	41
Gila Bend	1	9	0	5	0	0	3	0	0	18
Gila Bend H S	2	3	2	2	2	3	0	7	0	21
School District: Gila Bend Unified	3	12	2	7	2	3	3	7	0	39
Burk	0	0	0	0	0	0	5	0	0	5
Gilbert Elementary	0	4	0	2	0	0	6	3	0	15
Gilbert Jr High	2	19	5	8	5	5	29	44	0	117
Gilbert H S	15	61	18	30	18	32	60	109	0	343
Greenfield	0	1	0	0	0	1	0	1	0	3
Harris	2	0	0	1	0	1	5	2	0	11
Houston	0	2	0	0	0	0	0	1	0	3
Islands	0	2	0	0	0	1	0	0	0	3
Mesquite Jr High	4	7	5	3	2	7	11	26	0	65
Neely	0	0	0	0	0	1	2	1	0	4
Patterson	0	3	0	0	0	0	0	0	0	3
Pioneer	0	0	0	0	0	0	0	0	0	0
Val Vista	0	0	0	0	0	0	0	1	0	1
School District: Gilbert Unified	23	99	28	44	25	48	118	188	0	573
Glendale 1 Landmark	14	18	14	22	8	17	50	35	0	178
Glendale 2 Ives	2	1	1	0	0	8	1	0	0	13
Glendale 3 Smith	4	8	2	3	0	1	9	1	0	28
Glendale 4 Sine	0	0	0	1	0	0	3	3	0	7
Glendale 5 Jack	0	0	0	1	0	0	3	1	0	5
Glendale 6 Mesendick	2	3	0	7	0	2	13	3	0	30
Glendale 7 Burton	0	0	0	1	0	0	2	0	0	3
Glendale 8 American	0	0	1	2	0	1	2	0	0	6
Glendale 9 Bicent. N	0	0	0	0	0	0	0	0	0	0
Glendale 10 Horizon	1	2	0	1	0	0	2	1	0	7
Glendale 11 Challenger	11	24	20	21	3	20	50	40	0	189
Glendale 13 Discovery	0	2	0	0	0	0	3	2	0	7
School district: Glendale Elementary	34	58	38	59	11	49	138	86	0	473
Alternative High	0	0	0	0	0	0	0	0	0	0
Apollo H S	12	24	19	15	12	25	28	45	0	180
Cortez H S	5	17	15	11	3	11	22	54	0	138
Glendale H S	20	42	33	23	16	25	34	60	1	254
Greenway H S	6	29	10	7	16	16	31	75	0	190
Independence H S	13	12	9	10	11	15	32	21	1	124
Moon Valley H S	9	22	28	18	15	9	41	44	0	186
Sunnyslope H S	13	25	13	15	8	11	30	52	1	168
Thunderbird H S	8	27	7	9	4	11	28	77	0	169
Washington H S	14	27	26	14	15	9	41	42	0	188
School District: Glendale Union	100	225	160	122	100	132	285	470	3	1,597

## MARICOPA COUNTY JUVENILE COURT CENTER

Actual Schools 1993 By School Districts	Violent	Grand Theft	Obstruct	Fight	Drugs	Peace	Theft	Status	Hold	TOTAL
Higley Elementary	0	1	1	0	0	1	0	0	0	3
School District: Higley Elementary	0	1	1	0	0	1	0	0	0	3
East Valley	5	7	13	8	4	18	10	30	0	95
Estrella H S	0	2	0	0	0	0	0	0	0	2
Maricopa County Accom.	17	14	18	8	20	21	16	52	0	164
Thomas Pappas	3	9	7	10	5	4	16	11	1	66
West Valley Accom.	1	6	0	00	1	2	3	7	0	20
School District: Horse Mesa Accom.	26	36	38	24	30	45	45	100	1	347
Butler	0	1	0	0	0	1	9	19	0	30
Coe	2	2	2	2	0	0	10	4	0	22
Esperanza Primary	0	0	0	0	0	1	1	0	0	2
Isaac Jr High	25	53	24	27	19	32	76	159	0	415
Mitchell	3	1	0	0	0	2	6	2	0	14
Sutton	1	2	3	0	1	1	7	8	0	23
Zito	0	2	2	0	0	0	12	4	0	20
School District: Isaac Elementary	31	61	31	29	20	37	121	196	0	526
Akimol-A-AL Middle	1	5	0	2	2	4	6	1	0	21
Centennial Middle	2	5	3	5	2	8	10	4	0	39
Del Cielo	0	0	0	0	0	0	0	0	0	0
Del Norte	0	0	0	0	0	0	0	0	0	0
Del Pueblo	3	4	2	5	1	6	8	8	0	37
Del Sureno	0	0	0	0	0	0	0	0	0	0
De La Mariposa	0	0	0	0	0	0	0	0	0	0
De La Paloma	0	0	0	1	0	0	1	3	0	5
De Los Ninos	0	0	0	1	0	0	2	1	1	5
Kyrene Jr High	4	6	5	4	1	6	11	15	0	52
Monte Vista	0	0	0	0	0	0	0	0	0	0
School District: Kyrone Elementary	10	20	10	18	6	24	38	32	1	159
Cash	2	13	2	5	1	2	8	4	0	37
Estrella Mountain High	0	0	0	0	0	0	0	0	0	0
Laveen	0	3	1	0	0	0	1	1	0	6
School District: Laveen Elementary	2	16	3	5	1	2	9	5	0	43
Estrella Mountain	0	0	0	0	0	0	0	0	0	0
Liberty	0	1	0	2	1	0	0	1	0	5
School District: Liberty Elementary	0	1	0	2	1	0	0	1	0	5
Libby	0	0	0	0	0	0	0	0	0	0
Litchfield	0	1	0	0	0	0	0	0	0	1
School District: Litchfield Elementary	0	1	0	0	0	0	0	0	0	1
Littleton	0	3	1	3	1	6	2	5	0	21
Underdown Jr High	4	8	0	1	1	1	6	13	0	34
School District: Littleton Elementary	4	11	1	4	2	7	8	18	0	55
Madison Heights	0	0	0	0	0	0	0	0	0	0
Madison 1 Jr High	1	13	6	5	5	3	18	27	0	76
Madison 2 Park	5	1	1	0	0	1	7	23	0	38
Madison Meadows Jr High	0	0	1	1	0	0	8	5	0	15
Madison Rose Lane	0	0	0	0	0	0	0	0	0	0
Madison Simis	0	0	0	0	0	0	0	0	0	0
School District: Madison Elementary	6	14	8	6	5	4	31	55	0	129
Adams	2	5	0	2	0	1	5	0	0	15
Alma	0	0	0	0	1	0	0	0	0	1
Brimhall Jr High	4	13	1	9	2	9	22	6	0	68

## MARICOPA COUNTY JUVENILE COURT CENTER

Actual Schools 1993 By School Districts	Violent	Grand Thaft	Obstruct	Fight	Drugs	Peace	Theft	Status	Hold	TOTAL
Carson Jr High	13	35	9	18	11	19	74	45	0	224
Crimson	0	0	0	0	0	2	1	0	0	3
Dobson H S	13	47	14	17	28	52	44	48	0	283
Edison	0	1	0	3	0	2	5	0	0	11
Eisenhower	0	1	0	3	0	0	0	0	0	4
Emerson	1	0	0	0	1	1	3	2	0	8
Falcon Hill	0	0	0	0	0	0	0	0	0	0
Field	0	0	1	0	0	0	0	1	0	2
Franklin	0	1	0	1	0	0	5	0	0	7
Fremont Jr High	10	38	10	14	15	18	43	28	2	178
Frost	0	1	1	0	0	1	0	3	0	6
Hale	0	0	0	0	0	1	4	0	0	5
Hawthorne	1	0	0	0	1	0	2	0	0	4
Hendrix Jr High	9	31	5	20	7	25	42	66	1	208
Hermosa Vista	0	1	0	0	0	0	3	0	0	4
Highland	3	13	2	9	2	5	21	31	0	86
Holmes	0	2	0	0	1	0	1	3	0	7
Irving	1	6	1	0	0	0	1	0	0	9
Ishikawa	0	1	0	0	0	0	1	0	0	2
Jefferson	0	2	0	0	0	0	2	9	0	13
Johnson	0	0	0	2	0	0	0	1	0	3
Jordan	0	0	0	0	0	1	0	0	0	1
Keller	1	3	0	0	0	0	1	3	0	8
Kino Jr High	10	22	3	19	7	16	32	23	0	132
Lehi	2	0	0	1	0	0	7	1	0	11
Lincoln	0	2	0	1	0	0	8	1	0	10
Lindbergh	0	1	0	3	0	1	1	2	0	8
Longfellow	6	5	1	1	1	2	24	4	0	44
Lowell	1	0	0	0	0	0	1	0	0	2
MacArthur	0	0	0	0	0	0	0	0	0	0
Madison	1	3	0	3	0	0	3	0	0	10
Mendoza	0	0	0	0	0	1	2	0	0	3
Mesa Jr High	15	29	11	20	9	26	41	66	0	217
Mesa H S	20	55	17	12	20	37	39	22	0	222
Mesa Vista	32	105	71	28	36	84	80	125	1	560
Mesa Vo-Tech	0	5	1	4	8	5	3	7	0	33
Mountain View H S	7	10	5	8	6	18	46	18	0	118
O'Connor	1	0	0	0	0	1	1	0	0	3
Pomeroy	0	1	1	0	0	2	3	0	0	7
Poston Jr High	7	6	2	6	6	6	25	16	0	74
Powell Jr High	10	25	14	26	8	30	53	32	0	198
Red Mountain H S	5	62	14	12	12	23	44	8	0	180
Redbird	1	2	0	2	0	1	10	1	0	17
Rhodes Jr High	3	6	7	8	5	9	15	7	0	60
Robson	0	0	0	0	0	0	8	1	0	9
Roosevelt	2	1	0	0	0	0	3	2	0	8
Salk	0	0	0	3	0	3	1	4	0	11
Salt River Vista	0	0	1	0	0	0	2	0	0	3
SHARP	0	2	2	1	0	1	2	1	0	9
Shepherd Jr High	8	11	4	10	2	8	35	16	0	94
Sirina	0	2	0	0	0	1	4	2	0	9
Sousa	0	1	0	0	0	3	4	1	0	9
Stapley Jr High	0	0	1	0	0	0	1	0	0	2
Stevenson	2	5	0	0	0	3	4	0	0	14
Taft	0	2	0	0	0	0	0	0	0	4
TAPP	0	0	0	0	0	0	0	1	0	1
Taylor Jr High	6	6	4	8	6	4	26	15	0	75
Washington	0	0	0	0	0	0	0	0	0	0
Webster	0	2	2	0	0	1	2	2	1	10
Westwood H S	20	43	10	21	19	40	67	25	1	248
West Sky	0	2	0	2	0	0	3	0	0	7

## MARICOPA COUNTY JUVENILE COURT CENTER

Actual Schools 1993 By School Districts	Violent	Grand Theft	Obstruct	Fight	Drugs	Peace	Theft	Status	Hold	TOTAL
Whitman	0	7	1	2	0	0	5	0	0	15
Whittier	2	0	0	0	0	0	3	0	0	5
School District: Mesa Unified	219	624	216	297	214	463	688	649	6	3,576
Mobile	0	0	0	0	0	0	0	0	0	0
School District: Mobile Elementary	0	0	0	0	0	0	0	0	0	0
Garcia	2	0	1	3	3	0	2	14	0	25
Hamilton	5	9	5	1	3	5	5	18	2	53
Kuban	4	13	5	3	2	2	6	9	0	44
Sullivan	3	11	1	1	4	2	6	10	0	38
School District: Murphy Elementary	14	33	12	8	12	9	19	51	2	160
Nadaburg	3	3	1	4	1	4	6	6	0	28
School District: Nadaburg Elementary	3	3	1	4	1	4	6	6	0	28
Clarendon	2	6	0	1	0	1	9	10	0	29
Encanto	0	0	1	0	0	0	1	0	0	2
Grandview	0	1	0	0	0	0	0	0	0	1
Longview	1	8	0	2	1	3	7	7	0	29
Osborn Middle	16	33	4	18	2	9	38	57	0	177
Solano	1	3	0	0	1	0	6	1	0	12
School District: Osborn Elementary	20	51	5	21	4	13	61	75	0	250
Palo Verde	0	0	0	0	0	0	1	2	0	3
School District: Palo Verde Elementary	0	0	0	0	0	0	1	2	0	3
Paloma	1	0	0	0	0	0	0	0	0	1
School District: Palo Verde Elementary	1	0	0	0	0	0	0	0	0	1
Aire Libra	1	0	0	0	0	0	1	0	0	2
Arrowhead	1	0	0	0	0	2	3	1	0	7
Cactus View	0	0	0	0	0	3	1	0	0	4
Campo Bello	0	4	0	0	0	0	1	1	0	6
Cholla Middle	3	2	1	1	1	2	4	7	1	22
Desert Cove	0	0	0	0	0	0	1	1	0	2
Desert Shadows	1	2	1	1	0	0	8	4	0	17
Desert Shadows Middle	0	8	0	0	1	1	4	12	0	26
Desert Springs	0	0	0	0	0	1	1	0	0	2
Eagle Ridge	0	0	0	0	1	1	4	3	0	9
Echo Mountain	0	4	0	2	0	1	4	2	0	13
Foothills	0	0	0	0	0	0	1	0	0	1
Gold Dust	0	0	0	0	0	4	0	0	0	4
Greenway Middle	7	14	4	7	9	9	30	68	0	148
Hidden Hills	0	0	0	0	0	0	3	1	0	4
Horizon H S	9	42	15	9	20	23	68	136	0	322
Indian Bend	0	0	0	1	0	1	2	3	0	7
Larkspur	0	0	0	0	0	1	1	1	0	3
Liberty	0	0	0	0	0	0	0	0	0	0
Mercury Mine	0	0	0	0	0	0	1	0	0	1
North Canyon HS	3	14	6	3	7	13	15	30	0	91
Palomino	0	4	1	3	0	0	10	11	0	29
Paradise Valley H S	15	53	32	32	30	29	79	201	2	473
Polaris H S	0	1	2	1	1	1	4	11	0	21
Quail Run	0	0	0	1	0	0	4	3	0	8
Roadrunner	1	1	2	3	0	0	3	2	0	12
Sandpiper	0	0	0	0	0	0	2	3	0	5
Shadow Mountain H S	6	39	17	19	13	32	51	198	0	375
Shea	1	10	1	0	2	8	26	46	0	94
Sunrise Middle	4	8	0	5	4	4	16	39	0	80
TEAM	2	3	1	0	1	0	1	2	0	10

## MARICOPA COUNTY JUVENILE COURT CENTER

Actual Schools 1993 By School Districts	Violent	Grand Theft	Obstruct	Fight	Drugs	Peace	Theft	Status	Hold	TOTAL
Village Vista	0	0	0	1	0	0	0	4	0	5
Vista Verde Middle	6	25	7	9	11	10	30	53	0	151
School District: Paradise Valley Unified	60	234	90	98	101	146	379	643	3	1,954
Desert Horizon	4	7	2	7	3	4	26	14	0	67
Garden Lakes	1	3	0	2	0	0	2	0	0	8
Pendergast	0	4	0	2	1	1	5	3	0	16
Villa De Paz	2	11	0	3	0	1	4	3	0	24
Westwind	3	1	4	7	1	1	17	18	0	52
School District: Pendergast Elementary	10	26	6	21	5	7	54	38	0	167
Alta Loma	3	14	2	6	1	6	18	7	0	57
Apache	2	2	0	2	0	0	3	1	1	11
Cactus H S	17	23	13	15	6	20	42	24	0	160
Canyon	0	1	0	0	0	0	4	1	0	6
Centennial HS	6	16	13	7	18	11	21	15	2	109
Central	0	2	2	0	0	0	2	8	0	14
Copperwood	3	2	0	2	0	2	5	2	0	16
Cotton Ball	2	5	2	1	1	2	11	4	0	26
Davis	0	0	0	0	0	0	0	2	0	2
Desert Palms	2	4	0	3	0	3	5	0	0	17
Desert Valley	0	1	0	2	0	1	5	1	0	10
Foothills	2	3	0	1	0	0	6	1	0	13
Heritage	2	4	0	2	0	0	1	0	0	9
Ironwood H S	10	22	8	17	17	30	28	44	0	176
Kachina	0	1	0	9	0	4	8	2	0	24
Marshall Ranch	4	5	0	4	0	4	12	1	0	30
Murphy	0	3	0	1	0	4	4	3	0	15
Oakwood	0	0	0	0	0	0	3	3	0	6
Oasis	0	0	0	0	0	0	5	0	0	5
Peoria Elementary	3	2	3	3	1	3	11	6	0	32
Peoria H S	13	16	11	19	17	24	46	21	1	168
Pioneer	3	4	1	3	0	2	9	2	0	24
Sahuaro Ranch	1	1	1	0	0	1	2	6	0	12
Sky View	4	3	0	4	0	2	2	1	0	16
Sun Valley	1	0	0	1	0	0	4	2	0	8
Sundance	0	2	2	0	1	3	2	0	0	10
School District: Peoria Unified	78	136	58	102	62	122	259	157	4	978
Bethune	4	10	0	4	1	1	4	13	0	37
Capitol	2	6	0	0	0	1	1	1	0	11
Desert Vly Learning Ctr	14	27	2	4	3	5	2	24	0	61
Dunbar	0	3	0	2	0	0	4	1	0	10
Edison	11	7	2	3	3	3	2	18	1	50
Emerson	0	1	1	1	0	0	1	3	0	7
Faith North	0	0	0	0	0	0	1	0	0	1
Garfield	7	10	2	3	3	5	0	10	0	40
Heard	3	8	2	1	1	1	4	8	0	26
Herrera	5	11	2	2	2	2	3	13	0	40
Kenilworth	0	3	1	0	0	1	1	4	0	10
Lowell	0	0	0	0	2	0	3	8	0	13
Magnet Traditional	0	0	0	0	0	0	2	0	0	2
Ott	0	5	0	0	0	0	1	9	0	15
Phoenix Prep. Academy	38	57	40	13	21	35	35	115	1	356
Shaw Augi	1	3	1	1	0	1	4	9	0	20
Whittier	0	1	3	0	0	0	0	4	0	8
School District: Phoenix Elementary	85	150	56	34	36	55	69	240	2	727
Alhambra H S	22	65	33	23	21	46	70	106	2	388
Bostrum Alternative	8	24	8	8	5	15	10	35	0	113
Browne H S	43	66	28	28	39	48	89	197	0	538

## MARICOPA COUNTY JUVENILE COURT CENTER

Actual Schools 1993 By School Districts	Violent	Grand Theft	Obstruct	Fight	Drugs	Peace	Theft	Status	Hold	TOTAL
Camelback H S	23	132	35	25	29	39	98	118	2	501
Central H S	33	80	36	34	29	40	83	172	0	507
Cyesis East H S	1	0	0	0	1	0	0	0	0	2
Cyesis West H S	0	0	0	0	1	0	1	0	0	2
Desiderata H S	10	15	11	16	11	10	10	23	0	106
Hayden H S	33	83	33	17	19	42	74	182	0	483
Maryvale H S	39	84	34	33	39	35	81	177	0	502
Metro Tech VIP	34	40	31	17	13	20	38	68	1	262
North H S	31	91	24	16	22	34	62	110	1	391
South Mountain H S	98	120	70	50	38	75	126	216	1	792
School District: Phoenix Union	375	780	343	267	265	404	742	1,404	7	4,587
Queen Creek Elementary	0	0	0	0	0	0	0	0	0	0
Queen Creek Jr High	0	3	1	3	2	2	1	0	0	12
Queen Creek H S	1	0	2	1	2	7	8	3	0	24
School District: Queen Creek Unified	1	3	3	4	4	9	9	3	0	38
Riverside	0	5	2	1	7	0	2	4	1	22
School District: Riverside Elementary	0	5	2	1	7	0	2	4	1	22
Barr	8	10	4	9	2	6	4	13	0	54
Bush	0	1	1	0	0	2	2	3	0	9
Conchos	2	1	1	1	1	1	5	5	0	17
Davis	1	2	3	0	1	2	6	14	0	29
Greenfield	5	22	7	6	3	4	19	46	0	112
Jorgensen	5	7	1	2	1	6	1	11	0	34
Julian	5	11	3	6	5	13	15	9	0	67
Kennedy	1	2	0	1	0	1	5	0	0	10
King	1	1	0	0	0	0	2	2	0	6
Lassen	1	4	2	2	3	3	3	16	0	34
Palmdale	0	8	1	1	1	5	2	2	0	20
Rich	6	7	4	6	1	3	9	4	0	40
Rio Vista	1	4	2	1	1	1	7	26	1	44
Rose Linda	2	7	1	3	2	2	2	9	0	28
Sierra Vista	3	8	2	4	0	3	4	16	0	40
Southwest	3	8	6	5	0	0	8	1	0	31
Sunland	2	10	3	1	3	1	5	19	0	44
Valley View	2	1	3	1	1	1	6	6	0	21
School District: Roosevelt Elementary	46	114	44	49	25	54	105	202	1	640
Fisher	0	0	0	0	0	0	0	0	0	0
School District: Ruth Fisher Elementary	0	0	0	0	0	0	0	0	0	0
Alternative High	1	3	0	1	1	1	0	6	0	13
Anasazi	0	0	0	0	0	1	0	0	0	1
Arcadia H S	4	22	5	6	1	9	9	40	0	96
Chaparral H S	2	19	7	5	18	15	30	40	0	136
Cherokee	0	0	0	0	0	0	0	0	0	0
Cocopah	0	2	0	1	4	1	5	10	0	23
Coronado H S	7	21	17	23	14	29	33	45	0	189
Devereaux	2	2	1	3	0	7	3	4	0	22
Hohokam	0	0	0	0	0	0	0	1	0	1
Hopi	0	0	0	1	0	0	2	0	0	3
Ingleside	1	5	2	1	0	2	8	10	1	30
Kiva	0	1	0	1	0	1	1	0	0	4
Laguna	0	0	0	0	0	0	1	0	0	1
Mohave	3	9	2	6	0	9	16	10	0	55
Mountain Side Middle	1	1	1	2	1	2	12	2	0	22
Navajo	0	2	0	0	0	0	6	0	0	8
Pima	0	0	0	3	0	1	2	1	0	7
Pueblo	0	4	2	1	0	0	6	1	0	14

## MARICOPA COUNTY JUVENILE COURT CENTER

Actual Schools 1993 By School Districts	Violent	Grand Theft	Obstruct	Fight	Drugs	Peace	Theft	Status	Hold	TOTAL
Saguaro H S	18	38	15	22	25	37	48	61	0	264
Sequoia	0	0	0	0	0	0	3	0	0	3
Supai Middle	4	24	4	15	4	22	28	16	0	117
Tavan	0	0	0	0	0	0	1	0	0	1
Tonalea	0	1	0	0	0	0	1	1	0	3
Voc. Tech. Center	0	2	1	0	1	0	0	1	0	5
Yavapai	0	5	0	2	0	1	2	0	0	10
Zuni	0	0	0	0	0	1	0	0	0	1
School District: Scottsdale Unified	43	161	57	93	69	139	217	249	1	1,029
Sentinel	0	0	0	0	0	0	1	0	0	1
School District: Sentinel Elementary	0	0	0	0	0	0	1	0	0	1
Aguilar	0	1	0	0	0	0	1	0	0	2
Arredondo	0	4	0	0	0	0	4	0	0	8
Broadmor	0	0	0	1	0	0	0	0	0	1
Bustoz	0	0	0	1	0	0	0	0	0	1
Carminati	0	0	0	0	0	0	0	0	0	0
Connolly Jr High	2	18	7	10	4	11	25	35	0	112
Curry	0	1	0	1	0	0	4	0	0	6
Fees Intermediate	7	15	0	6	4	9	25	57	0	123
Frank	2	2	0	1	0	2	4	2	0	13
Fuller	0	0	0	0	0	1	0	0	0	1
Gilliland Middle	13	41	6	16	9	18	56	50	0	209
Holdman	1	3	1	0	0	0	0	2	0	7
Hudson	2	0	0	0	0	3	1	0	0	6
Laird	0	0	0	0	0	0	0	0	0	0
McKemy Middle	4	16	5	5	3	8	24	22	0	67
Meyer	1	0	0	0	0	0	2	0	1	4
Nevitt	0	1	0	1	0	0	3	1	0	6
Rover	0	0	0	0	0	3	1	0	0	4
Scales	0	2	0	0	0	0	1	2	0	5
Thew	1	6	1	1	0	1	2	2	0	14
Wood	1	0	0	1	0	0	3	0	0	5
School District: Tempe Elementary	34	110	20	44	20	56	156	173	1	614
Corona Del Sol H S	10	27	20	12	6	30	35	57	0	199
Marcos De Niza H S	11	29	20	20	25	30	70	95	0	300
McClintock H S	14	45	18	19	22	48	66	93	0	325
Mountain Pointe H S	11	44	13	18	15	15	65	34	0	215
Tempe H S	16	48	16	25	12	29	75	91	0	312
School District: Tempe Union	62	193	87	94	82	152	311	370	0	1,351
Tolleson Elementary	0	0	0	0	0	0	4	0	0	4
Tolleson Jr High	5	3	1	4	0	6	9	8	0	36
School District: Tolleson Elementary	5	3	1	4	0	6	13	8	0	40
Tolleson Union H S	9	19	14	9	17	14	36	66	0	184
Westview H S	16	52	25	20	16	17	39	91	0	276
School District: Tolleson Union	25	71	39	29	33	31	75	157	0	460
Union Elementary	0	5	0	0	0	0	1	0	0	6
School District: Union Elementary	0	5	0	0	0	0	1	0	0	6
Acacia	1	0	1	2	0	1	0	2	0	7
Alta Vista	0	1	0	1	0	2	5	0	0	9
Arroyo	0	0	0	0	0	1	2	1	0	4
Cactus Wren	0	0	0	1	0	2	0	0	0	3
Chaparral	0	5	2	4	0	2	6	3	0	22
Cholla Elementary	0	0	0	0	1	0	0	2	0	3
Cholla Jr High	0	7	5	6	5	3	14	12	0	52

## MARICOPA COUNTY JUVENILE COURT CENTER

Actual Schools 1993 By School Districts	Violent	Grand Theft	Obstruct	Fight	Drugs	Peace	Theft	Status	Hold	TOTAL
Desert Foothills Jr High	2	6	5	8	5	4	25	34	0	89
Desert View	3	3	0	0	1	0	8	7	0	22
Ironwood	2	3	0	2	1	1	2	2	0	13
Jacobs	0	0	0	0	0	0	0	0	0	0
Lakeview	1	2	0	3	0	2	3	2	0	13
Lookout Mountain	0	0	0	1	0	0	1	0	0	2
Manzanita	2	3	0	1	0	0	1	2	0	9
Maryland	0	0	0	0	0	2	3	1	0	6
Miller	0	1	0	0	0	0	0	0	0	1
Moon Mountain	0	2	0	2	0	3	5	5	0	17
Mountain Sky	7	9	5	3	3	5	24	64	0	120
Mountain View	4	19	9	8	6	10	25	8	0	89
Ocotillo	1	0	0	2	0	0	8	2	0	13
Orangewood	1	1	0	1	0	0	5	1	0	9
Palo Verde Jr High	7	13	9	20	3	9	30	84	0	175
Road Runner	5	3	4	6	1	0	7	15	0	41
Royal Palm Jr High	14	29	10	17	1	10	60	146	0	267
Sahuaro	2	4	4	3	3	10	10	12	0	45
Senita	0	0	0	0	0	0	0	1	0	1
Shaw Butte	1	2	0	1	0	0	6	3	0	13
Sunburst	1	0	0	0	0	0	1	1	0	3
Sunnyslope	2	4	1	2	0	0	16	9	0	34
Sunset	2	0	0	0	0	0	3	1	0	6
Sweetwater	0	0	0	1	0	0	1	0	0	2
Tumbleweed	0	0	0	1	0	0	1	1	0	3
Washington	0	1	0	1	0	1	4	5	0	12
School District: Washington Elementary	56	118	55	97	30	68	276	426	0	1,128
Garcia	0	0	0	0	0	0	0	1	0	1
MacLennan	0	0	0	0	0	0	0	0	0	0
Vulture Peak	0	2	3	7	0	6	11	6	0	35
Wickenburg H S	0	3	2	2	0	4	9	4	1	25
School District: Wickenburg Unified	0	5	5	9	0	10	20	11	1	61
Williams AFB Accom. School District: Williams AFB Accom.	0	0	0	1	0	2	3	4	0	10
Wilson	2	5	1	2	1	2	3	11	0	27
Wilson Primary	0	1	0	0	0	0	0	9	0	10
School District: Wilson Elementary	2	6	1	2	1	2	3	20	0	37
Glendale Comm. College	2	8	5	1	3	1	8	10	0	38
Mesa Community College	1	2	0	0	0	1	0	0	0	4
Maricopa Tech. College	1	0	0	1	0	0	0	0	0	2
Phoenix College	5	2	0	1	1	2	1	6	0	18
Scottsdale Comm.College	1	0	0	0	0	1	2	0	0	4
College Total:	10	12	5	3	4	5	11	16	0	66
Bourgade Catholic H S	0	1	0	0	2	0	1	2	0	6
Brophy Prep	2	12	1	4	5	6	5	31	0	66
Christ Lutheran	0	3	0	0	0	0	1	0	0	4
Good Shepherd Lutheran	0	1	0	0	0	0	0	0	0	1
Grace Christian	0	0	0	0	0	0	1	0	0	1
Grace Lutheran	0	0	0	0	0	0	1	0	0	1
Most Holy Trinity	1	0	0	0	0	0	0	0	0	1
Our Lady of Perpetual Help - Glendale	1	0	0	0	0	0	0	0	0	1
Our Lady of Perpetual Help - Scottsdale	0	0	0	0	0	0	1	1	0	2
Phoenix Christian	0	0	1	1	0	0	3	1	0	6
Scottsdale Christian	0	0	0	0	0	2	0	3	0	5



## MARICOPA COUNTY JUVENILE COURT CENTER

Actual Schools 1993 By School Districts	Violent	Grand Theft	Obstruct	Fight	Drugs	Peace	Theft	Status	Hold	TOTAL
Saton H S	0	1	0	1	0	1	2	1	0	6
St Agnes	0	0	0	0	0	0	0	1	0	1
St Frances Xavier	0	0	1	1	0	0	0	2	0	4
St Gregory	0	0	0	0	0	0	0	1	0	1
St Jerome	0	0	0	0	0	0	1	0	0	1
St Johns	0	0	0	0	0	0	2	1	0	3
St Mary's Elementary	0	0	0	0	0	0	1	0	0	1
St Mary's H S	0	0	1	2	2	6	14	11	0	36
St Matthew	0	0	1	0	0	0	0	1	0	2
St Simon	1	0	0	0	0	0	0	0	0	1
St Theresa	0	0	0	1	0	0	0	0	0	1
St Thomas	0	0	0	0	0	0	1	0	0	1
St Vincent	0	0	1	0	0	0	0	0	0	1
Southwest Indian	0	0	1	0	0	1	0	1	0	3
Thunderbird Adventist	0	0	0	0	0	0	0	2	0	2
Tempe 7th-Day Adventist	0	0	0	0	0	0	1	0	0	1
Xavier H S	1	0	1	0	1	0	9	6	0	18
Parochial Schools Total:	6	18	8	10	10	16	44	65	0	177
Excelsus	0	1	1	0	0	0	1	2	0	5
Garfield Girl's	1	1	1	2	0	0	1	0	0	6
Judson	3	1	0	1	0	0	4	1	0	10
New Way	0	0	0	0	0	1	0	1	0	2
Ombudeman	18	73	59	31	19	44	31	82	2	359
Phoenix Country Day	0	0	0	0	0	0	2	0	0	2
Wayland	3	3	5	6	2	0	2	8	0	29
Misc. Other Total:	25	79	66	40	21	45	41	94	2	413
Other Not Listed Above	117	243	144	148	88	157	342	355	15	1,809
Unknown or No School:	169	474	102	175	196	291	527	2,238	72	4,244
Total	1,994	4,969	2,028	2,366	1,751	3,058	6,355	10,466	130	33,117