

SM 14.2 MARCH 1988

(Supersedes SM 14.2  
dated July 1972,  
which may be used.)

---

# RESCUE SKILLS AND TECHNIQUES

FORMERLY FG-E-11.1

STUDENT MANUAL

138379

---

federal emergency  
management agency



U.S. Department of Justice  
National Institute of Justice

138379

This document has been reproduced exactly as received from the person or organization originating it. Points of view or opinions stated in this document are those of the authors and do not necessarily represent the official position or policies of the National Institute of Justice.

Permission to reproduce this copyrighted material has been granted by  
Public Domain/Federal Emergency  
Management Agency

to the National Criminal Justice Reference Service (NCJRS).

Further reproduction outside of the NCJRS system requires permission of the copyright owner.

# RESCUE SKILLS AND TECHNIQUES

NCJRS

AUG 31 1992

ACQUISITIONS

SM 14.2, March 1980  
(Supersedes SM 14.2, July 1972)



**FEDERAL EMERGENCY MANAGEMENT AGENCY**

## CONTENTS

Chapter	Page
1. Organization and functions .....	1
Purpose of this guide.....	1
Mission of rescue.....	1
Command structure.....	1
Agreement among services.....	2
Operating unit.....	2
Squad leader; deputy squad leader; team leader; deputy team leader; rescue truck driver/storekeeper; rescue workers.....	3
Training.....	4
Individual and team training; continuing training; rescue training facilities.....	4
Standard operational procedures.....	4
2. Care and use of equipment.....	5
Squad equipment.....	5
Recommended rescue squad equipment.....	5
Rope.....	8
Terminology; care of manila rope; coiling manila rope, care and use of wire rope; knots; life basket.....	9-12
Ladders.....	13
Terminology; care and handling of ladders; setting and raising ladders; raising straight ladder; raising regular extension ladder with two men; raising regular extension ladder with three men.....	13-17
Lifting devices.....	19
Levers; jacks; block and tackle; care and use of block and tackle; reeving a tackle; gain in power; precautions; other lifting devices.....	19-23
Protective breathing equipment.....	23
Filter-type mask; self-contained breathing apparatus; demand breathing apparatus; special precautions; training; use of lifeline.....	23-25
Cutting tools.....	26
Tunneling and debris removal tools.....	26
Lighting and power equipment.....	26
Equipment available from other services.....	26
3. Rescue techniques.....	28
Lashings.....	28
Square lashing; diagonal lashing; figure-eight lashing; round lashing.....	28-29
Holdfasts.....	29
Deadmen and pickets.....	30
Rigging.....	32
Gin pole; sheerlegs (A-frames); tripod; jib; use of ladders in rigging; ladder gin pole; ladder sheerlegs.....	32-36
Slings.....	37
Debris tunneling.....	37
Timbering and lining tunnels.....	38
Trenching.....	42
Breaching walls.....	42
Ventilation.....	43
Raising and supporting structural elements.....	44
Shoring; raking shore; flying shore; dead or vertical shore; strutting; removing walls.....	44-48
Debris handling.....	49

<i>Chapter</i>	<i>Page</i>
4. Casualty handling .....	50
Emergency first aid .....	50
Controlling bleeding; giving artificial respiration; mouth-to-mouth technique of artificial respiration; splinting of fractures; reducing shock; emergency treatment of burns .....	50-57
Removal of casualties .....	57
Carries and drags; removal with equipment .....	57-62
Hoisting and lowering casualties .....	69
Horizontal methods; using a ladder as a stretcher; vertical methods; backboard as stretcher; carrying stretchers; other methods .....	69-73
Disposition of casualties .....	73
Tagging casualties .....	76
5. Appreciation of damage to buildings and utilities .....	78
Damage to buildings .....	78
Types of collapse and formation of voids .....	78
Preattack inspections .....	80
Hazards from industrial chemicals and damaged utilities .....	80
Water; domestic gas; electricity; sewers .....	80-81

## ORGANIZATION AND FUNCTIONS

### PURPOSE OF THIS GUIDE

1.1 This guide has been prepared for use as a textbook in rescue training courses at FEMA-approved training schools and is to be used in rescue training programs of State and local governments. This publication explains rescue skills and techniques to those who are training for rescue service in peacetime or attack-caused emergency. It describes the rescue squad's tools and equipment and gives instructions for their use. The wide range of operations that squadmen perform; such as, rope and ladder work, lashing and rigging, shoring, tunneling, trenching, and casualty handling, are covered in detail. This guide also contains information on basic types of building construction and the ways in which buildings may collapse as a result of blast or other causes.

### MISSION OF RESCUE

1.2 The FEMA supports and encourages peacetime development of rescue units and capabilities, partly because of their lifesaving value in peacetime emergencies, and partly because of the base they provide for developing the larger rescue capabilities that would be needed in an attack-caused emergency.

1.3 The peacetime utility of rescue operations extends to all emergencies that can result in persons being trapped or located in inaccessible places. This can include, among other things, people trapped in structures damaged by earthquakes, explosions or fires, trapped miners, injured hunters or mountain climbers, or victims of severe electric shock.

1.4 Rescue operations would be needed in a massive scale during attack emergencies. The aim of rescue would be to save the lives of victims who were unable to assure their own survival without assistance. This includes, but is not limited to freeing survivors trapped in damaged buildings. A much greater need would exist to assist injured people in uncontrollable-fire areas to reach safer places.

1.5 Some of these "immediate rescue" operations would be conducted by rescue, fire, police and other forces working from the "outside in," until firespread terminated rescue operations. But in most cases, disabled survivors would have to be released, and if necessary assisted to escape areas threatened by uncontrollable fires, through opera-

tions from the "inside out." Such rescue would be provided by uninjured survivors, including police, fire, or other emergency service forces in the area. Time would obviously be of the essence in immediate-rescue operations, and not many heavily trapped people could be released.

1.6 "Re-entry rescue" operations would be undertaken, after fires had subsided, and as levels of radioactivity allowed, to locate and release heavily trapped persons still surviving. Time would not be as critical, though still important, and heavy rescue techniques involving the use of equipment could be applied. This could include rescue vehicles obtained through the civil defense program as well as other equipment normally available in the locality.

Rescue is regarded, for civil defense purposes, as a function. Responsibility for rescue is often assigned to the local fire or police department, or to a division of the public works engineering department. These departments train and maintain skilled rescue units or squads to provide rescue service in peacetime accidents or incidents. In some communities, the rescue unit may not be closely affiliated with a major department of local government.

1.7 Peacetime rescue units should be used as a cadre or nucleus around which a greatly expanded rescue organization would be built by training and organization during crisis periods. This emergency rescue capability or service should be developed by whatever governmental department is responsible for the rescue function in peacetime. If no department has peacetime rescue functions, responsibility may be assigned to the police, fire, or public work engineering department.

1.8 Volunteer rescue squads (that are in some cases autonomous) should participate in planning, and form part of the cadre for crisis training and expansion. The same is true for various types of specialized units—for example, industrial, mining or mountain rescue units—that are manned with experienced rescuemen.

### COMMAND STRUCTURE

1.9 A chief of rescue should be designated by the head of the department to which the rescue service is assigned, and rescue should be under the general direction of the chief of rescue.

1.10 The chain of command should be the same for rescue as for other divisions of the major

governmental departments to which rescue is assigned.

1.11 Within the chain of command, a rescue officer should be designated to command each rendezvous area (prearranged assembly point for rescuemen and equipment). (Any self-extrication from shelter rescue effort will be under the direction of the shelter manager, and as possible, will be coordinated with outside-of-shelter rescue efforts, if any.)

### AGREEMENT AMONG SERVICES

1.12 Regardless of what department of government has the major rescue responsibility, other departments will be responsible for a limited amount of rescue and for cooperation with the rescue service. For example, even though rescue may be under the public works department, firemen will continue to rescue persons from burning buildings as part of their normal duties. Both

in and out of shelter nearly all of the protective services engaged in civil defense operations will participate in rescue to some degree. Therefore, operating plans for rescue should take into consideration operating plans of other services and agreements reached on what service does what, who assumes command when more than one service is involved in a rescue operation, and what communications nets will be used.

### OPERATING UNIT

1.13 FEMA recommends a squad of 26 men as the basic operating unit of a rescue organization in the postshelter emergency period. Rescue squads are of two types:

(a) Light-duty squads, trained and equipped for operations in areas where damage to structures is expected to be light. If organized, in-shelter rescue efforts and rescue efforts from shelters directed at the immediate vicinity would involve

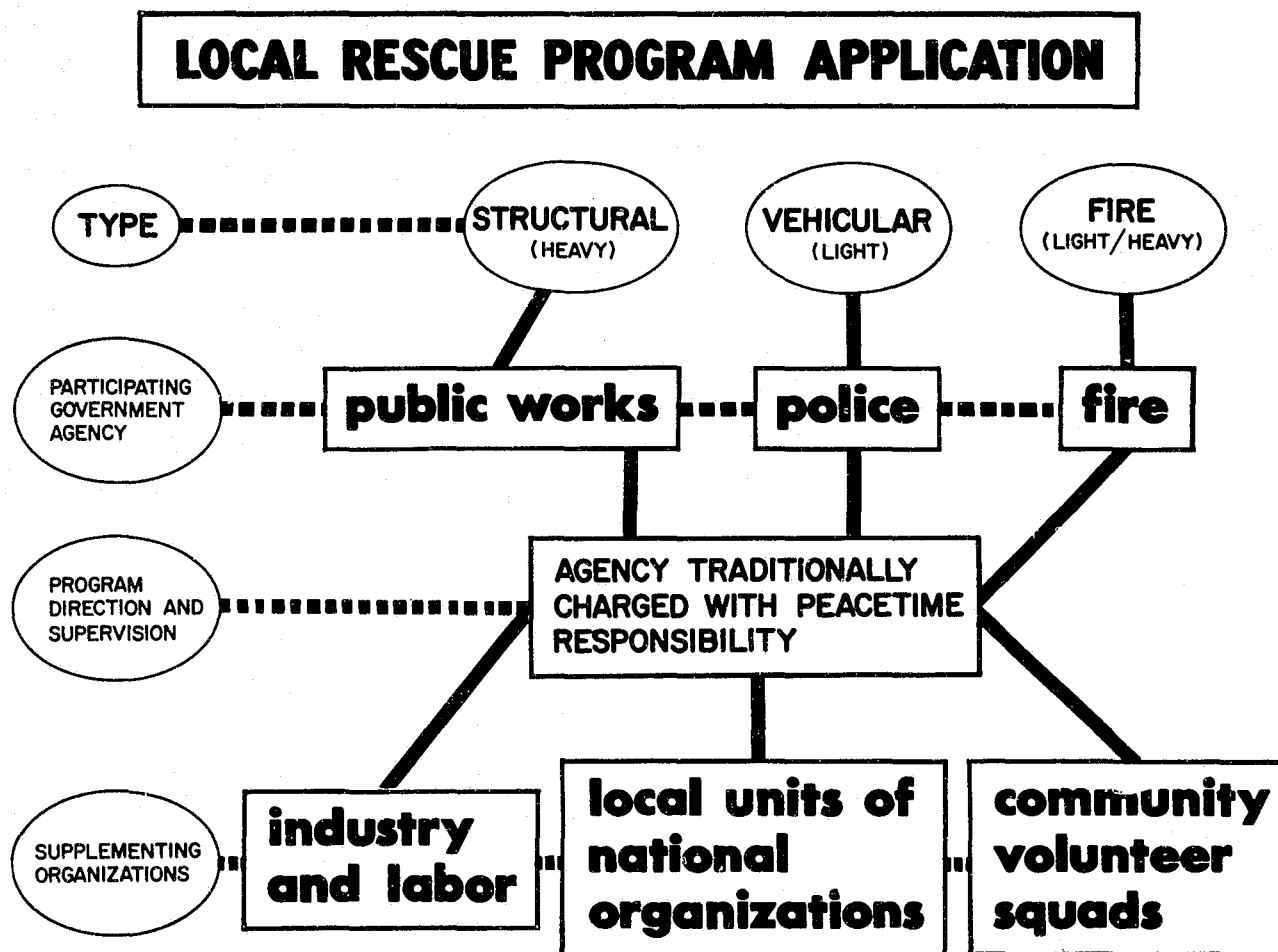

FIGURE 1.—Local rescue program application.

light duty rescue squads or the smaller light duty rescue teams. The light duty squad has a leader, a deputy leader, and six teams of four men each, one of whom is the team leader.

(b) Heavy-duty squads, trained and equipped for rescue in areas of heavy damage. The heavy-duty squad has a leader, deputy leader, and three teams of eight men each, one of whom is a team leader.

### **SQUAD LEADER**

1.14 Operation of the rescue squad is the responsibility of the squad leader.

In preparation for emergency he should:

- (a) Organize the squad into teams.
- (b) Supervise training.
- (c) Develop and enforce regulations for squad and team operation.
- (d) Supervise obtaining, replacing, and maintaining equipment.
- (e) Conduct reconnaissance and inspection, locating and identifying any special hazards in his in his area such as underground storage or pipelines of volatile liquid or gases.

(f) Direct the squad during exercises.

1.15 In an emergency he should:

- (a) Report to the scene of rescue operations.
- (b) Conduct reconnaissance.
- (c) Make assignments to team leaders at the scene of operations.
- (d) Arrange for spot training of expanded rescue forces (including training during the in-shelter period, as appropriate).
- (e) Ensure that correct rescue methods and techniques are used.
- (f) Request additional men, tools and assistance as needed.
- (g) Arrange for relief periods for teams.
- (h) Arrange for food and rest for squadmen.
- (i) Designate a team leader to act as squad leader in the absence of the squad leader and deputy.
- (j) Keep a log of squad activities.
- (k) Make reports, as required, following completion or suspension of each operation.

### **DEPUTY SQUAD LEADER**

1.16 The deputy squad leader should assist the squad leader in organizing and training the squad.

He must be able to assume command in the leader's absence.

### **TEAM LEADER**

1.17 In preparation for an emergency each leader should:

- (a) Assist in organizing the team.
- (b) Direct the training of team members, individually and as a team.
- (c) Furnish detailed information to team members about shelters and structures from which they may have to effect rescue.
- (d) Conduct rescue training exercises.
- (e) Supervise team members in the use and maintenance of equipment.
- (f) Maintain team discipline.

1.18 In an emergency he should:

- (a) Carry out the squad leader's orders.
- (b) Conduct emergency spot training of expanded rescue forces (including training during the in-shelter period, as appropriate).
- (c) Supervise his team in performing assigned rescue work.
- (d) Enforce safety regulations.
- (e) Ensure proper tagging of casualties.
- (f) Supervise the use of the equipment and of the rescue service truck when assigned to him.
- (g) Report to the squad leader any injury to personnel or damage to equipment and the need for replacement of personnel or equipment.
- (h) Request additional help when needed.

### **DEPUTY TEAM LEADER**

1.19 The deputy team leader assists the team leader in carrying out his duties. The deputy must be able to take charge in the leader's absence and to direct part of the team when it is split into smaller operating units.

### **RESCUE TRUCK DRIVER/STOREKEEPER**

1.20 In addition to his duties as a regular team member, the driver/storekeeper is responsible to the squad leader for the maintenance and operation of the rescue truck. He should:

- (a) Keep the truck clean and in running order.
- (b) Maintain the truck and accessories in accordance with instructions in the handbooks accompanying the equipment.
- (c) Keep each tool in its proper place, ready for operational use at all times.

(d) Report needed repairs and supplies to the team leader.

During the in-shelter period, he becomes a member of the shelter safety team.

## **RESCUE WORKERS**

1.21 All rescue workers should know civil defense rescue methods and techniques and the plan of rescue operations.

1.22 Good sources of rescue manpower are existing rescue organizations and building trades.

1.23 Most auxiliaries will probably have little, if any, rescue experience and will require training in all the elements of rescue operations; specifically in:

(a) Rescue skills and techniques, including self-extrication from shelter and first aid.

(b) Use of squad equipment.

(c) Maintenance of personal equipment so that it will be ready for use at all times.

(d) General maintenance of rescue truck and equipment.

(e) Following local instructions on mobilization and work assignments.

Against the possibility that may exist that there may only be one trained rescueman in a particular shelter, where possible, every rescueman should also be able to organize for and conduct in-shelter rescue training.

## **TRAINING**

1.24 Complete and thorough training in rescue techniques and in the use of equipment is necessary for capability in the discharge of emergency responsibilities. Squad leaders, team leaders, and other keymen of the rescue organization should plan and direct rescue training in cooperation with civil defense training officials. After initial training is completed, frequent practice sessions should be held to maintain interest, proficiency, and discipline.

## **INDIVIDUAL AND TEAM TRAINING**

1.25 Each man must be individually trained in rescue techniques and operations and in working as

a member of a team. He must know what he is to do during each of the shelter phases. Team training will develop mutual trust and understanding among members, team spirit, and confidence in leaders. It will also benefit leaders by giving them experience in making decisions while teams are in action.

## **CONTINUING TRAINING**

1.26 After team members have learned the fundamentals of rescue and the value of teamwork, they should participate in practice sessions that approximate actual rescue operations. Some exercises should be carried out in darkness and in heavy smoke. Simulated casualties should be used in these exercises. This training should be realistic and be conducted frequently on a regular schedule to help maintain member interest and keep teams at peak efficiency.

## **RESCUE TRAINING FACILITIES**

1.27 Rescue training is most effective when conducted under realistic conditions. FEMA will provide, upon request, plans and specifications for the construction of optimum rescue training facilities. Pending the availability of (or in lieu of) optimum training facilities, excellent training facilities can be improvised in any community where abandoned or condemned buildings are available. Such buildings can be readily adapted for rescue training, including self-extrication-from-shelter techniques.

## **STANDARD OPERATIONAL PROCEDURES**

1.28 Under emergency conditions, rescue squads may be ordered to unfamiliar areas to work with rescue units with which they have had no previous contact. Effective cooperative operations will depend in large measure on similarity of procedures, techniques, training and equipment. FEMA publications, training courses, and equipment lists are designed to promote standardization for rescue units throughout government.



## CARE AND USE OF EQUIPMENT

### SQUAD EQUIPMENT

2.1 Certain tools and equipment are essential for effective rescue squad operation. The equipment listed in this chapter is the optimum; however some rescue organizations may want to add specific items, depending on local situations or preference.

2.2 The equipment listed is in two categories—light duty and heavy duty. Quantities in each are ample for a team.

2.3 Many types of tools and heavy machinery not part of the regular rescue squad equipment may be needed during rescue operations. Equipment, such as tractors, cranes, air compressors, and pavement breakers, should be available to rescue team leaders from the engineering services.

2.4 Transport must be provided for a squad's members and equipment. The best transport is a special purpose vehicle which carries a rescue team and its equipment. The equipment should be readily accessible in special compartments. FEMA has designed and approved such vehicles which may be procured by States and local civil defense organizations under the Federal contributions program.

2.5 Existing vehicles may be converted to transport vehicles if the compartments are constructed in accordance with FEMA standards. Standardization simplifies their use by relief teams of mobile support forces.

2.6 Trailers may be used to transport rescue equipment, or the equipment may be stored in tool boxes ready for loading on a flatbed truck.

### RECOMMENDED RESCUE SQUAD EQUIPMENT

2.7 Standard light duty rescue tools and equipment per team of four men:

Description	Quantity per set
Band, webbing, for casualty handling (set of 4).	1
Bar, wrecking, ½" x 12" long, gooseneck, claw and pinch point.	2
Bar, wrecking, 1" x 30" long, gooseneck, claw and pinch point.	2
Blanket (cotton and wool).....	4
Boots, rubber, pullover, shoe (pair).....	4
Box, tool, 19" x 7" x 7".....	1
Bucket, galvanized, 14-qt. (heavy gage)...	2
Can, safety, oil, 1-gal.....	1
Canteen, wo/cup.....	4
Chain, 6', 5,000 lb., close link, type A, class I, grade II, grab hook and ring.	1
Chisel, hand, cold, ¾" x 12".....	2
Coat, rain, jacket, medium length.....	4
Container, debris, bucket-type.....	2
Container, water, drinking, 5-gal. cap....	1
Cord, sash, cotton braided, 15' long.....	4
Cord, whipping, ball.....	2
Coveralls, 2 medium, 2 large.....	4
Crayon, lumber marking, red, yellow....	6
Extinguisher, water, hand pump, 4 gal..	1
Gloves, heavy debris (pair).....	4
Gloves, leather, protective (pair).....	1
Gloves, rubber, insulating (pair).....	1
Goggles, dustproof, shatterproof.....	4
Hacksaw, frame, w/10 blades.....	1
Hammer, sledge, 4-lb. w/handle.....	1
Hammer, sledge, 8-lb. w/handle.....	1
Hatchet, carpenter's.....	2
Helmet, protective, wo/lighting bracket..	4
Hydraulic spreading and pulling set, 4-ton cap., in case.	1
Jack, screw, 5-ton cap., w/handle.....	2
Kit, first aid, belt type, filled, w/1 refill..	4
Ladder, extension, 20'—2-section.....	1
Light, safety approved, battery.....	4
Plier-wrench, type U, class 1, style 1, 8½"	2
Pliers, 8", elec., wire-cutting, w/ins. handle.	2
Rope, manila, ½" dia., 50' lengths.....	4
Rope, manila, ½" dia., 150' lengths.....	2
Rope, manila, ¾" dia., 100' lengths.....	3
Rope, wire, ⅜" dia., 10' long, type VIIa spliced loop ends.	2
Ruler, folding, carpenter's, 6'.....	2
Saw, hand, 26" cutting edge.....	2
Screwdriver, 16½", common.....	2
Sheeting, rubber, black, 45" wide, 84" long.	4

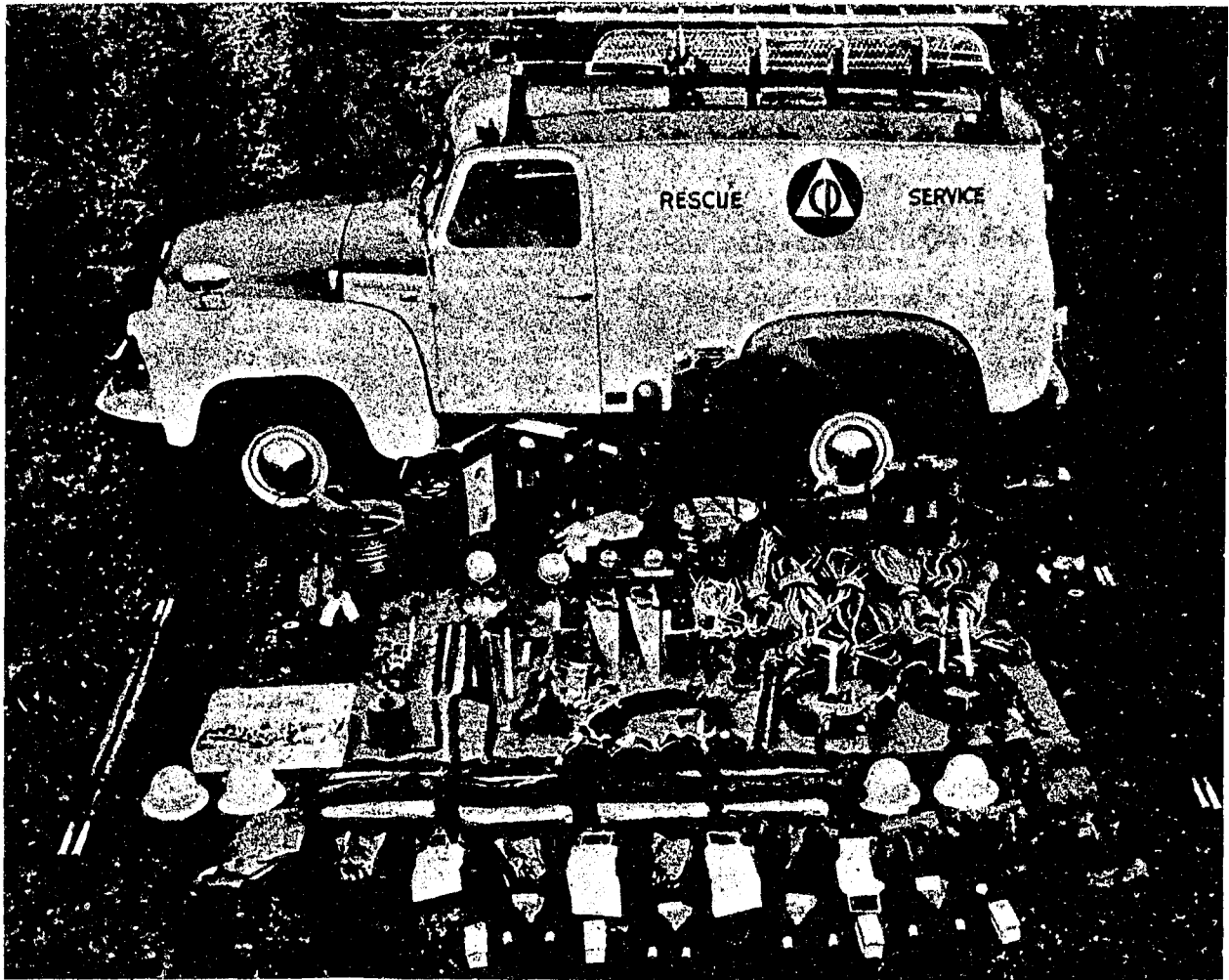

FIGURE 2.—Light duty rescue truck and equipment.

Description	Quantity per set	Description	Quantity per set
Shovel and pick combination.....	2	Hoist, winch type, portable, ¼-ton cap..	1
Snatch block, steel; heavy duty, type II, class 2, size 1, 8" (for wire rope).	1	Inhalator, portable, w/case.....	1
Snips, tin, 8½", type II, class A.....	1	Jack, ratchet, 5-ton cap., w/lever.....	2
Stake, metal, 30" long, 1" dia.....	4	Ladder, roof, 12' w/folding hooks.....	1
Stretcher, latest Army type (canvas)....	2	Light, flood, portable, generator powered.	2
Stretcher, Stokes type.....	1	Light, red-flashing, battery powered.....	2
Tackle block, manila rope, 4" (2-sheave) w/becket.	2	Power unit, gas driven, 1 kw. portable, A.C.	1
Wrench, pipe, adjustable, heavy duty, 14".	2	Protective mask, canister type, with carrying case, available in 4 sizes.....	4
		Radio, mobile, 2-way.....	1
		Radiological dosimeter charger.....	1
		Radiological dosimeter, self-reading.....	4
		Radiological survey meter.....	1
		Saw, pruning, dbl. edge, 18" blade.....	1

2.8 Supplemental light duty rescue equipment:

Cord, extension, 100', for flood lights w/ wye.	1
Cord, extension, 50', for flood lights w/ wye.	2
Clipper, bolt, ½", 18" long, type II, class C.	1
Hammer, cross-peen, 3-lb., w/handle....	1

2.9 Standard heavy duty rescue tools and equipment per team of eight men:

Apparatus, self-contained, breathing, each w/3 canisters.	2
Axe, 4-lb., single bit, w/handles.....	2

Description	Quantity per set
Bag, burlap, 60-lb. cap., sand	48
Band, webbing, for casualty handling	2
Bar, pinch, 30'' long	1
Bar, wrecking, 3/4'' gooseneck, claw and pinch point, 30'' long, offset type.	2
Bit, 1'' auger	2
Blanket, asbestos, protective w/canvas container.	1
Blanket (cotton and wool)	8
Boots, rubber, pullover, shoe, short, United States Rubber or equal (pairs).	8
Brace, ratchet head, 12'' sweep	1
Bucket, galvanized, 14-qt. (heavy gage)	6
Can, safety, gasoline, 1-gal.	1
Canteen, wo/cup, 2 qt.	8
Chain, 6' long, 1,700 lb. cap.	2
Chain, 6' long, 2-ton cap., w/grab hook and ring.	1
Chisel, hand, cold, 3/8'' x 8''	2
Chisel, hand, cold, 3/4'' x 12''	2
Chisel, hand, 3/4'' x 18''	2
Coat, rain, jacket, medium length	8
Container, debris, bucket type	8
Container, water, drinking, 5-gal. cap.	1
Container, gas, safety, 5-gal. cap.	1
Cord, extension, 100', for floodlights, w/ twist lock waterproof connectors.	5
Cord, extension, 50', for floodlights, w/ connectors.	2
Cord, sash, cotton braided, 15' long, No. 8	8
Coveralls, 4 medium and 4 large	8
Crayon, lumber marking, red and yellow	12
Crowbar, 66'' length, w/chisel edge (pinch point).	2
Crowbar, 72'' long, 1 1/2'' hexagon handle, w/mushroom and flat ends.	2
Cutter, bolt, 36'' long, 3/8''	1
Cutter, pipe, 3/8'' to 2'', 3-wheel type	1
Gear, lifting tackle, 1 1/2 ton cap., 112'' lift.	1
Gloves, heavy debris (pairs)	16
Gloves, rubber insulating (pairs)	2
Goggles, dustproof, shatterproof	8
Hacksaw, frame, w/10 blades	1
Hammer, claw, 16-oz. w/handle	4
Hammer, ball-peen, 3-lb. w/handle	2
Hammer, sledge, 4-lb. w/handle	2
Hammer, sledge, 8-lb. w/handle	2
Hammer, sledge, 16-lb. w/handle	1
Hatchet, carpenter's	2
Heater, unit, single-burner, pressure type, gas-burning for boiling water.	1
Helmet, protective, wo/lighting bracket	8
Jack, ratchet, 5-ton cap., w/lever	2
Jack, ratchet, 15-ton cap., w/lever	2
Jack, screw, 5-ton cap.	2
Kit, first aid, belt type, each w/8 refills in separate container.	8
Ladder, roof, 12' w/folding hooks	1
Ladder, extension, 28'—2-section	1
Ladder, collapsible, 10'	1

Description	Quantity per set
Light, red-flashing, battery powered	4
Light, flood, portable, generator powered	3
Light, safety approved, battery	8
Mask, gas, filter type, w/canister	4
Outfit, cutting, oxygen-acetylene, w/goggles and gloves, 2 spare oxygen tanks, 1 spare acetylene.	1
Pick, point, and chisel, w/handle	2
Pick, poll, or mining, w/handle	2
Pliers, 8'', comb., slip joint w/cutter	4
Pliers, 8'', wire-cutting, w/ins. handle	1
Pole, pike, 8'	1
Power unit, gas. drive, 2 1/2 kw. portable, AC.	1
Pump, stirrup, w/20' hose and jet nozzle	1
Rope, manila, 1/2'' dia., 50' lengths	8
Rope, manila, 1/2'' dia., 150' lengths	4
Rope, manila, 3/4'' dia., 200' lengths	1
Rope, manila, 3/4'' dia., 300' lengths	1
Rope, manila, 1'' dia., 300' lengths	1
Rope, wire, 3/4'' dia., 15' lengths, w/ capped and eye ends for lashings.	6
Rope, wire, 3/8'' dia., 10' lengths, w/ shackle and eye ends.	2
Rope, wire, 3/4'' dia., 50' lengths, w/hook and eye.	2
Ruler, folding, carpenter's, 6'	1
Saw, chain, elec., 18'' w/extra chain	1
Saw, crosscut, 4 1/2'' blade	1
Saw, hand, 26'' cutting edge	1
Saw, floor, silver steel, 10-pt., 18'' long	1
Saw, power, elec., portable, 8'' w/case	1
Blades: Combination	2
Nailcutting	2
Carboly	2
Saw, pruning, dbl. edge, 18'' blade	1
Screwdriver, common, 16 1/2''	1
Shears, tinnerns, 12'' (snips)	1
Sheeting, rubber, black, 45'' wide, 84'' long.	8
Shovel, round, pointed, long handle	2
Shovel, square mouth, D-handle	2
Shovel, tunneling, short D-handle, 18'' long.	2
Stake, metal, 30'' long, 1'' dia.	8
Stretcher, latest Army type (canvas)	4
Stretcher, Stokes type	1
Tackle block, manila rope, 8'' (snatch)	1
Tackle block, manila rope, 6'' (2-sheave)	2
Tackle block, manila rope, 6'' (3-sheave)	2
Tackle block, manila rope, 6'' single-sheave snatch.	3
Tackle block, manila rope, 4'' (2-sheave)	8
Tackle block, 3/8'' wire rope (single snatch)	2
Tape, 50' metallic, graduated in inches and sixteenths.	1
Tarpaulin, 8' x 10'	1
Telephone set, self-energizing, w/400' of wire, complete.	1
Wrench, pipe, 24'' Stillson	2
Wrench, adjustable, crescent, 12''	1



FIGURE 3.—Heavy-duty rescue truck and equipment.

## ROPE

2.10 Rope is one of the most important tools of a rescue unit. Squads will use both steel wire and manila ropes, and the efficiency with which rope can be used will depend to a great extent on proper care and maintenance.

2.11 Ropes will be used to erect derricks and jibs, lift materials and equipment, rescue injured persons, join equipment such as ladders, lower stretchers, and for lifelines. Practice and drill are the only methods by which squadmen can become proficient in the use of rope.

2.12 Table 1 shows working strengths of various sizes of rope, with adequate safety factors considered. Strengths shown for the various sizes are based on new rope. If the age and condition of rope are not known, the rope should be

thoroughly inspected and tested before it is approved for service.

TABLE 1.—Working strengths of rope

Size-diameter	Wire	Manila
Inch	Pounds	Pounds
3/8	2,100	270
1/2	3,600	530
5/8	5,500	880
3/4	7,900	1,080
1	14,000	1,800

## TERMINOLOGY

2.13 The following is standard rope and knot terminology:

(a) *Standing part*.—That part of a rope taking the load.

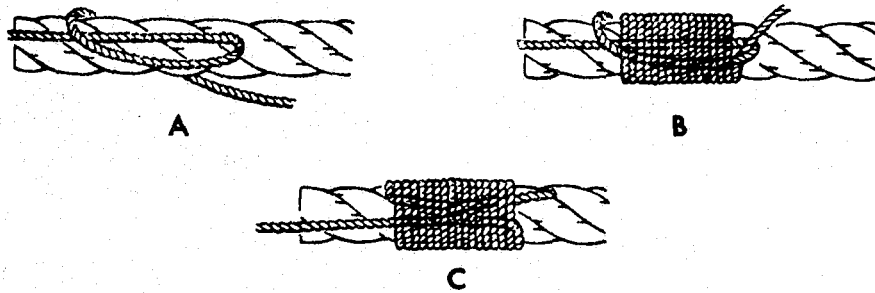

FIGURE 4.—Method of whipping rope.

(b) *Running part*.—Free end of rope.

(c) *Anchored*.—Fastened to some immovable object.

(d) *Whipping*.—Process of tying end of rope to prevent strands from unraveling.

(e) *Bight-in-rope*.—Formed by bending rope, keeping sides parallel.

(f) *Round turn*.—Formed by looping running part of rope over an object or standing part.

#### CARE OF MANILA ROPE

2.14 The following rules should be observed in the care of manila rope:

(a) For easy handling, new manila rope should be stretched its entire length before use.

(b) Rope ends should be whipped or temporarily knotted to prevent fraying. (Fig. 4 shows a method of whipping rope.)

(c) Rope should be kept as dry as possible. If it gets wet it should not be dried by heat, but should be stretched on a ladder or suspended from supports so air can get to the fibers. When dried by heat, manila rope loses its natural oil and becomes brittle.

(d) Do not let rope strands be cut by sharp edges. If necessary to pass a rope over a sharp edge, pad the edge with a board or sandbag. Rope should not be dragged along the ground. Sand and grit will work into the rope, cutting it and causing abrasions of the inner fibers. After use, rope should be carefully inspected for cut strands.

(e) In storage, ropes should be off the ground, free from extreme temperatures, and away from contact with materials containing acids or strong alkalis.

(f) Oil or grease must not be applied to manila rope. They allow dust and grit to collect on the rope and prevent air from reaching the fibers.

(g) When not in use, rope should be coiled and ready for an emergency.

#### COILING MANILA ROPE

2.15 The following methods of coiling rope are essential to rescue work:

(a) *Regular coil*.—Should be clockwise, or to the right, because of the natural twist in the rope. (See fig. 5.) If the rope kinks when coiled, it is because a reverse twist has been given it while in use. To remove this, coil it counterclockwise.

(b) *Rescue coil*.—(See fig. 6.) Commonly used method of coiling heavy rope for ease in carrying and for dropping from high places. It will readily uncoil without kinking and drop quickly and accurately. The coil is made on a special frame approximately 22 inches on center or on the end of a ladder. Many ropes used for rescue, particularly those of  $\frac{3}{4}$ -inch diameter or larger, have a loop or eye at one end, generally formed by an eye splice. Start with the eye end, allowing the eye to protrude approximately its own length. If there is no eye, leave about an arm's length of rope for a handle. For a 100-foot length of  $\frac{3}{4}$ -inch rope, coil seven turns of rope around the frame in the first layer and six turns in the second layer, making sure that the rope is reasonably tight and that the second layer falls neatly into the grooves formed by the first layer of rope. Next, coil rope at right angles to the two layers so prepared (A, fig. 6). When the coil is finished, remove it from the frame. Then double the remaining portion of rope and pass it through loop opening in end of coil (B, fig. 6)

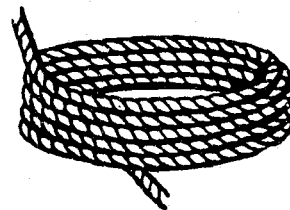

FIGURE 5.—Regular coil of rope.

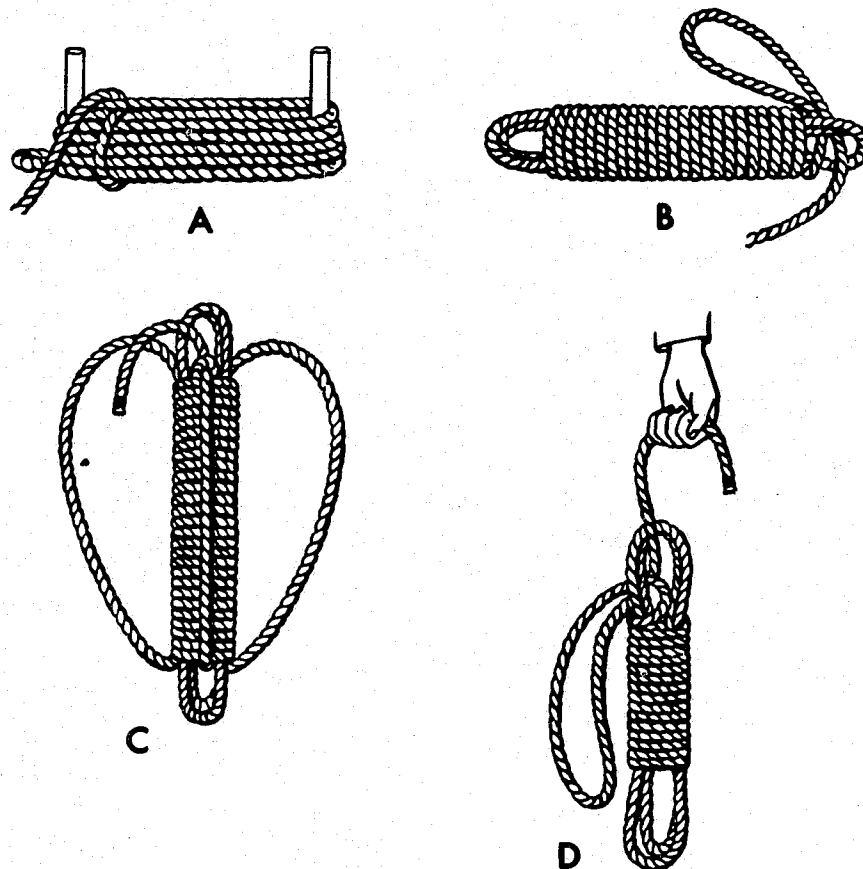

FIGURE 6.—Steps in making rescue coil.

and through the loop opening in the opposite end of the coil. This makes two loops to go over the shoulders so rope can be carried on the back (C, fig. 6). Adjust shoulder straps by loosening or pulling the double rope. When the straps are adjusted bring the remaining single rope up the side of the coil and tie a becket in the small loop formed by the shoulder straps as they protrude through the coil loop. To uncoil, untie becket and shoulder carry. Then holding the loop end, pull two or three lengths of rope from the coil so it will uncoil freely as it is dropped (D, fig. 6). When making a rescue coil with rope of other lengths or thickness, the number of turns required around the frame can best be determined by trial. After a proper length has been established, a piece of friction tape may be put on rope to indicate enough has been coiled on the frame.

#### CARE AND USE OF WIRE ROPE

2.16 Wire rope is used for lashing and slings and on the winch of rescue trucks for hoisting and dragging heavy objects and pulling down walls. It is about nine times stronger than manila rope of the same size.

2.17 Wire rope should be straight, without loops, before any pull is exerted. A pull on a loop will cause a kink, damaging the strands. After each use, wire rope should be cleaned and oiled to prevent rusting. It should be kept away from fire as even a slight burn will weaken the rope and render it dangerous for further use. In coiling for storage, care should be taken to avoid bending the rope too sharply.

#### KNOTS

2.18 Although there are many knots which can be used and practiced, those listed should be adequate. Squadmen should be able to tie the following knots automatically and in pitch darkness:

(a) *Thumb or overhand knot.*—(See fig. 7.) Used temporarily on the end of a rope to prevent

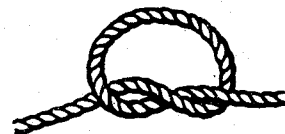

FIGURE 7.—Thumb knot.

fraying, and sometimes tied on the end of a rope to prevent the rope from running through a block. To tie, form a loop, making sure the running end of the rope crosses the standing part, then pass the end around the standing part and through the loop.

(b) *Figure-eight knot*.—(See fig. 8.) As a stopper knot, the figure-eight knot is larger, stronger, and easier to untie than the thumb or overhand knot. It is equally secure, but less damaging to the rope fibers.

(c) *Half hitch*.—(See fig. 9.) Basis of many knots, and one method used to attach a rope to a pole or hook. To tie, pass the short end of a rope around a pole (or another rope) and over the standing part, so that when pulled, one part of the rope binds on the other. Two half hitches often are placed on a pole or rope; they won't slip under strain.

(d) *Clove hitch*.—(See fig. 10.) Useful for hoisting timbers and rescue tools, and fastening a rope onto another rope stretched between two points. May be used at end or middle of a rope. To tie, make two half hitches. Or, pass running end around pole, bringing it out underneath standing end, and pass the running end over the



FIGURE 8.—Figure-eight knot.



FIGURE 9.—Half hitch.

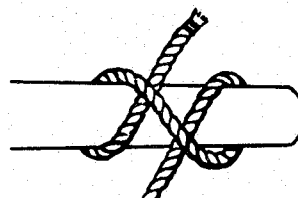
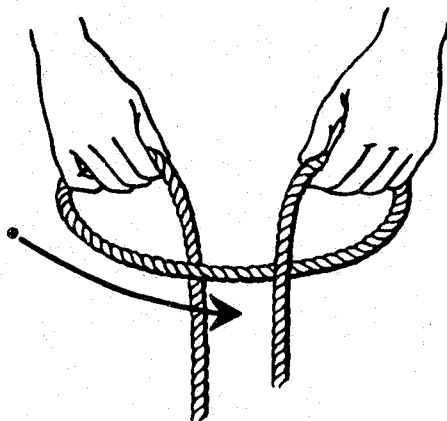

FIGURE 10.—Clove hitch.

standing end and around the pole again. Then bring the running end under itself to tighten, pulling both the running and standing end. To tie in the middle of a rope (see fig. 11), form two counterclockwise loops, one in the left hand and one in the right hand, the latter being passed in front of the left hand loop. Pass both loops over pole and draw tight.

(e) *Single sheet bend or becket*.—(See fig. 12.) Useful for joining two ropes of different sizes together, will not slip under conditions of varying tension or when rope is wet. To tie, make a loop in the end of the thicker rope, pass the end of the other through it and form a half hitch around the loop of the first rope.



A

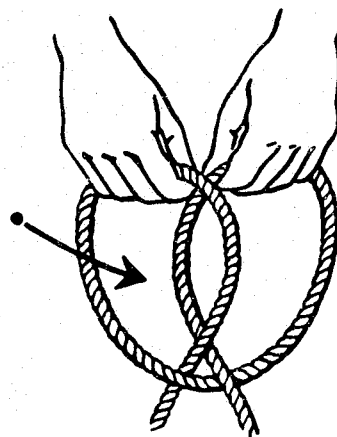

B

FIGURE 11.—Making clove hitch in middle of rope.



FIGURE 12.—Single sheet bend or becket.



FIGURE 13.—Double sheet bend or double becket.

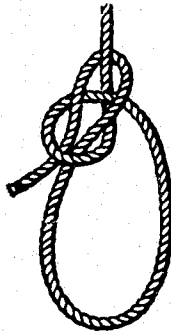

FIGURE 14.—Bowline.

(f) *Double sheet bend or double becket.*—(See fig. 13.) More secure than the single sheet bend. Used for joining ropes when there is great difference in their sizes. Formed in a manner similar to a single sheet bend except, after forming the first half hitch, continue with short end to make another turn around the two thicknesses of the thick rope and toward the bight.

(g) *Bowline.*—(See fig. 14.) A good securing knot; also makes a nonslipping loop in the end of a rope. Used to tie a lifeline to a rescue worker and used frequently in raising and lowering heavy objects and tools. To tie, throw a loop in the rope,

then pass the free end through the underside of the loop, around the standing line and back through the loop.

(h) *Bowline-on-a-bight.*—(See fig. 15.) Most useful in raising or lowering a stretcher or ladder horizontally. Its double loop provides greater safety than a single loop. To tie, use a double rope and form a loop as in tying a bowline. Pass the free end through the loop as in tying a bowline (A, fig. 15). Then bring the free end toward you, drop it, and bring the two loops through it (B, fig. 15), pulling on the two ropes which form the right side of the loop. This will draw the loop which has been passed through the bight behind the loop in the double rope, forming a bowline-on-a-bight (C, fig. 15).

(i) *Timber hitch.*—(See fig. 16.) A quickly made temporary knot for lifting spars, poles, and planks. Commonly used with a half hitch at the other end of the timber when lifting. Formed by passing the running end around the object and making a half hitch on the standing part of the rope and twisting the long running end back around itself.

(j) *Square knot.*—(See fig. 17.) Used to tie triangular bandages in first aid. To tie, hold both ends, one in each hand. Lay one rope on the other, and pass one end around the other rope. Do the same thing a second time, using the opposite rope on top, and draw tight.

#### LIFE BASKET

2.19 A life basket (see fig. 18) combines several of the knots described in paragraph 2.18. It provides safe, comfortable support in raising or lowering casualties or rescuers in confined areas, or

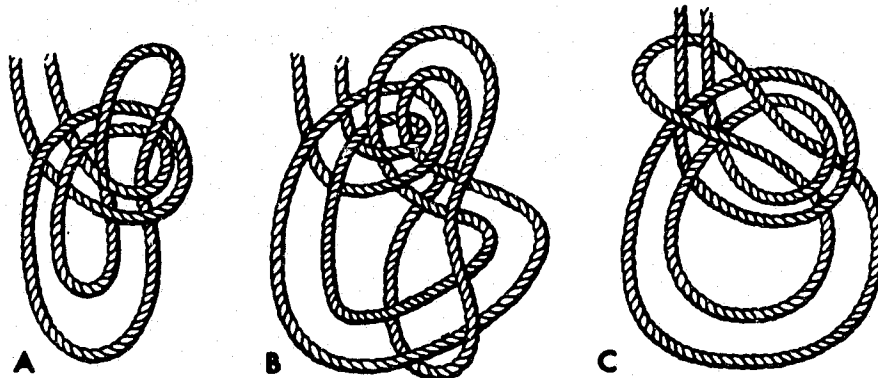

FIGURE 15.—Bowline-on-a-bight.



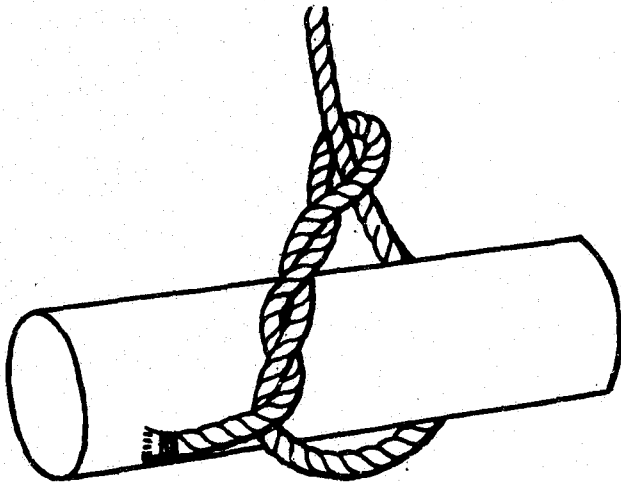

FIGURE 16.—Timber hitch.

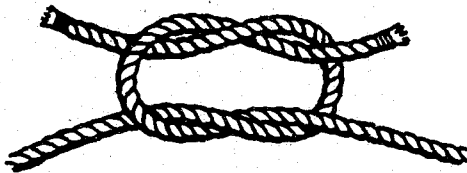

FIGURE 17.—Square knot.

lowering them from heights. To make a life basket, form a bowline-on-a-bight (A, fig. 18) as explained in paragraph 2.18(h). Place bowline in position on body (B, fig. 18) with standing end forming a half hitch around chest. Secure chest hitch by: passing lower bight through upper bight (C, fig. 18); passing tail end from bowline-on-a-bight through chest bight (D, fig. 18); and hauling up on standing end from chest hitch until bight a passes completely through bight b, pulling tail end c through with it (E, fig. 18). Completed life basket in position on body ready for raising or lowering is shown in F, figure 18.

## LADDERS

2.20 Ladders are used not only for climbing, but also as bridges, derricks, stretchers, and for other purposes. Squadmen should understand their care and handling, practice with them, and become proficient in their use. To develop team work, practice with ladders is essential. Familiarity in working with ladders at heights can only be acquired by many hours of practice. This chapter covers the handling and placing of ladders, the correct use of ladders in climbing and the care of this equipment. The use of ladders in handling casualties is described in chapter 4.

## TERMINOLOGY

2.21 The following is standard ladder terminology:

- (a) *Rail or beam.*—Main structural part of a ladder.
- (b) *Rungs.*—Cross members used in climbing a ladder.
- (c) *Straight ladder.*—A one-section ladder.
- (d) *Extension ladder.*—A ladder built in sections.
- (e) *Bed.*—Lower section of extension ladder.
- (f) *Fly.*—Upper section of extension ladder.
- (g) *Heel or butt.*—Bottom or ground end of ladder.
- (h) *Top or tip.*—Top of ladder.
- (i) *Heelplate.*—Metal at heel of ladder.
- (j) *Fly rope.*—Rope used to hoist fly.
- (k) *Pulley.*—Small grooved wheel through which fly rope is drawn.
- (l) *Paul (or dog).*—Rung latch on heel of fly.

2.22 DCPA light and heavy rescue equipment lists include ladders that are adequate for the rescue service. If longer or larger ladders are needed, they can be obtained from fire or other services.

## CARE AND HANDLING OF LADDERS

2.23 Ladders should be varnished, but never painted, since paint conceals defects. They should be inspected regularly for cracks or flaws and cleaned frequently. Ladders should be handled carefully. They should be used only for purposes for which they are intended, and never overloaded.

2.24 The safest method of carrying a roof ladder (see fig. 19) is to place it on either shoulder, passing the arm through the ladder at the middle of its length, hooks to the front.

2.25 Figure 20 shows how one man can carry an extension ladder. The heel should always be forward so the ladder can be set and raised in one operation.

2.26 When two men carry a ladder, they should stand on the same side (A, fig. 21). Each passes an arm through the ladder and grasps the rail on the second rung forward. When carrying it through a crowded place, the lead man takes a position well to the front, using his outside hand to prevent injury to persons in the line of travel.

2.27 When two men lift a ladder off the ground, each should grasp a rung, with the palm of the hand turned downward. When the ladder

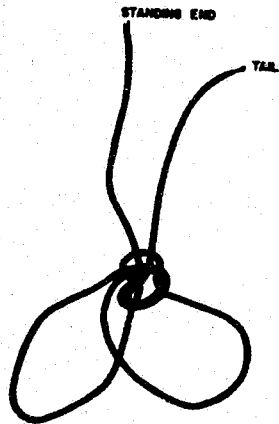

A-BOWLINE-ON-A-BIGHT

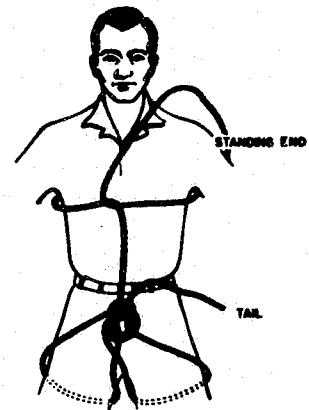

B-BOWLINE IN POSITION ON BODY

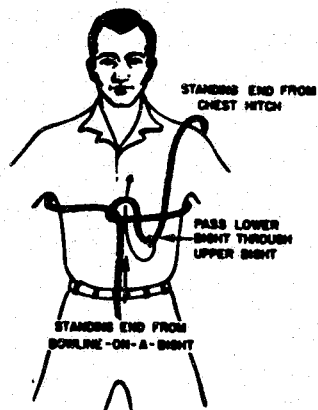

C-STEP 1 IN SECURING CHEST HITCH

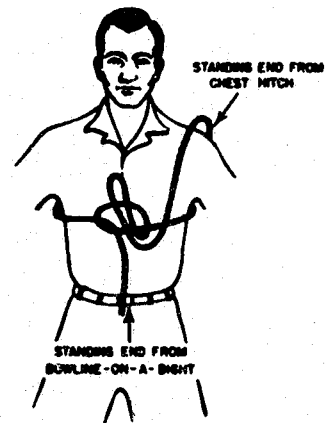

D-STEP 2 IN SECURING CHEST HITCH

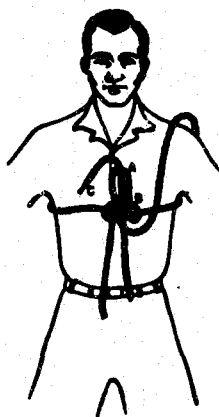

E-STEP 3 IN SECURING CHEST HITCH

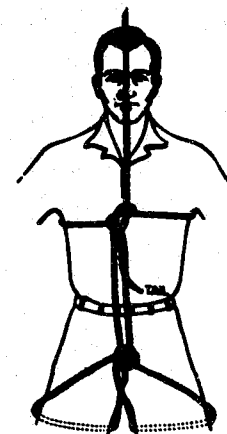

F-COMPLETED LIFE BASKET

FIGURE 18.—Steps in making life basket.

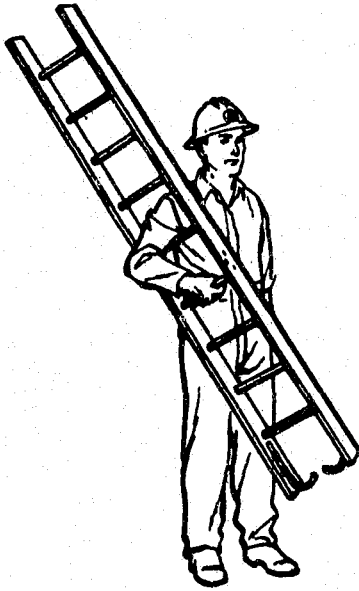

FIGURE 19.—Carrying roof ladder.

is lifted it will fall naturally alongside their bodies (B, fig. 21).

**SETTING AND RAISING LADDERS**

2.28 To establish the proper angle for safe climbing and assure maximum strength under

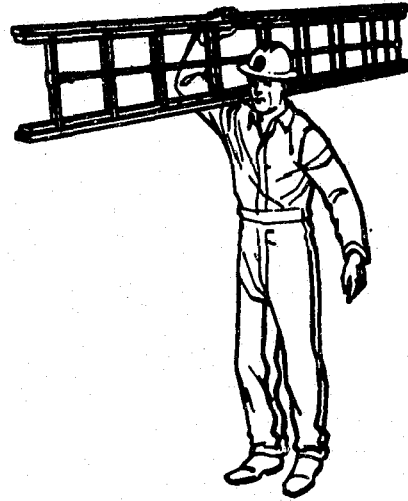
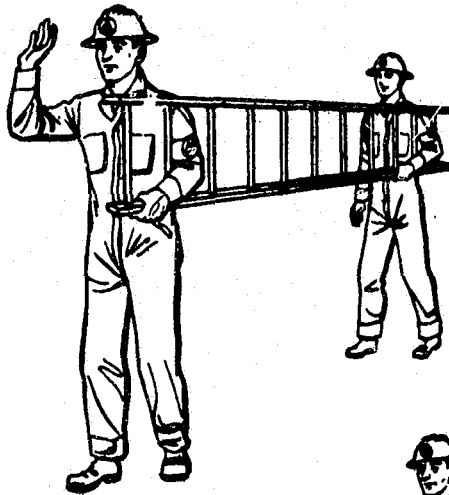

FIGURE 20.—One man carrying extension ladder.

heavy loads, either of the following methods is used to determine the distance the heel should be placed from the buildings:

(a) Divide the extended length of the ladder by 5 and add 2. For example, if a 25-foot extended ladder is used, the proper distance of the heel from the building is 7 feet, since one-fifth of 25 is 5, and 2 feet are added.



A

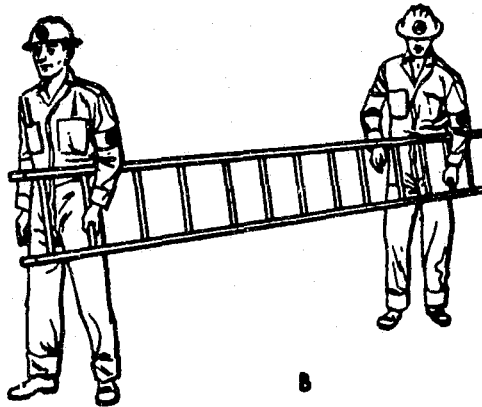

B

FIGURE 21.—Two-man ladder carry.

(b) Take one-fourth of the length of the extended ladder and place the heel that distance from the building. The proper position of the heel of a 25-foot ladder would be approximately 6 feet from the building, since one-fourth of 25 is approximately 6.

2.29 Ladders should be placed so the climber's body is perpendicular to the ground at all times. When the climber's arms are extended for climbing and his body is perpendicular to the ground, climbing is easy and safe. (See fig. 22.) If the heel of the ladder is too far from the building, the climber must lean forward. If it is too close, he must hug the ladder to keep from falling backward.

2.30 Ladders should be placed so climbers can get in and out of the windows easily. Place the ladder against the sill to either the far side or opposite the working side of the window, *not in the center*.

#### RAISING STRAIGHT LADDER

2.31 In raising straight ladders, the number of men required to carry the ladder will usually be the number required to raise it. For a one-man raise, the following procedure is recommended:

- (a) Remove ladder from truck.
- (b) Carry ladder to location as described in paragraph 2.25.



FIGURE 22.—Safe ladder-climbing position.

(c) Place heel of ladder on ground against building or some stationary object.

(d) With both hands, raise ladder to vertical position by walking toward the heel, simultaneously grasping and pushing forward on alternate rungs. (See fig. 23.)

(e) With both hands grasp ladder on two rungs about three rungs apart. Lift ladder off ground and carry heel back to proper position for climbing.

(f) To lower, reverse procedure.

#### RAISING REGULAR EXTENSION LADDER WITH TWO MEN

2.32 Although one man can raise a 24- or 26-foot regular extension ladder, two are recommended. For longer ladders, at least three men should be used. Two men raising a regular extension ladder should:

(a) Remove ladder from truck and carry it to location as described in paragraph 2.26.

(b) Position ladder parallel to building, with heel directly below point where top is to rest.

(c) Turn ladder over on rail to raise it.

(d) To "heel" the ladder, one man places his forward foot on bottom rail, reaches out, and grasps top rail with hands well spaced. His other foot is held as far back as possible to act as a counterweight. The heel man aids in raising the ladder by pulling as much as possible with his



FIGURE 23.—One-man ladder raise.

extended hand, steadying the ladder as it is raised, and holding down the heel with his foot (A, fig. 24.)

(e) The second man faces top of ladder, and with his inside hand, palm back, grasps rung about one-third of the distance back, and raises the ladder over his head. He swings under it and pushes the ladder upward while walking toward the heel (B, fig. 24).

(f) Once the ladder is upright, the two men move into position on opposite sides, facing each other through the ladder. The inside man (nearer building) steadies the ladder, while the outside man facing the building raises the fly and secures it into place by seating the dogs and tying the fly rope.

(g) The outside man places one foot on lowest

rung of the ladder and eases top of ladder against building (C, fig. 24).

(h) To lower the ladder, reverse the procedure.

2.33 To raise ladder at right angles to building, use same procedure, pivoting ladder before raising fly.

### RAISING REGULAR EXTENSION LADDER WITH THREE MEN

2.34 To raise a regular extension ladder with three men, the following procedure is recommended:<sup>1</sup>

(a) Remove ladder from truck and carry it to location, placing heel at proper distance from

<sup>1</sup> This procedure also applies to raising longer extension ladders without the use of poles.

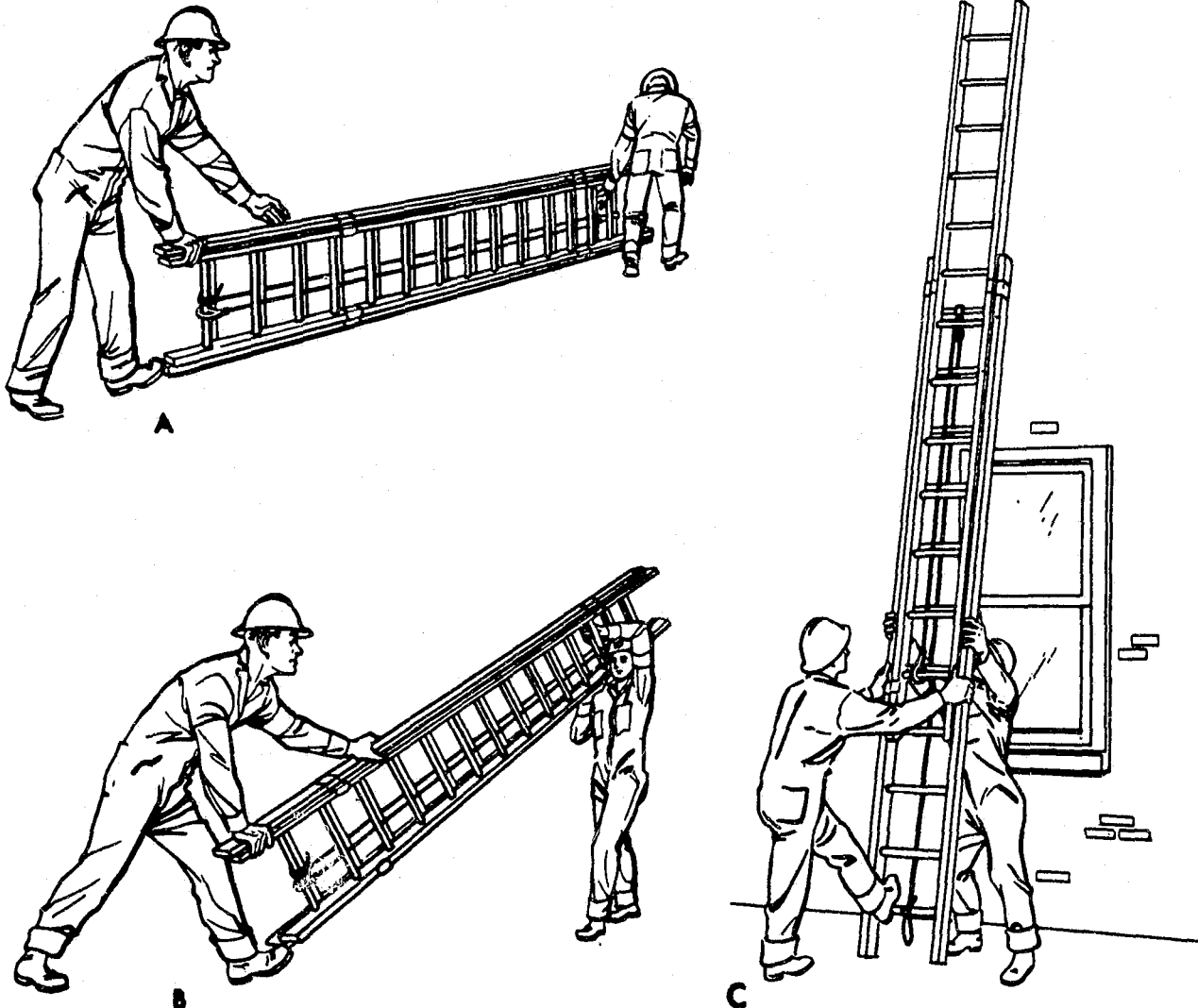

FIGURE 24.—Two-man ladder raise.

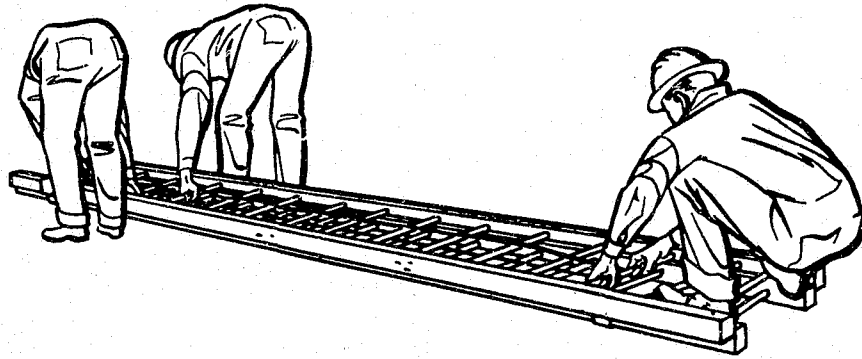

FIGURE 25.—Three-man ladder raise.

building before ladder is raised. (The heel man determines proper position.)

(b) The ladder is laid flat, with fly on bottom. (See fig. 25.)

(c) With his back to the building, No. 1 man stands on first rung, reaches forward and grasps a rung with both hands and assists in raising ladder.

(d) Facing the top of the ladder, No. 2 and No. 3 men space themselves about one-third of the distance from the top of the ladder. They reach down with their inside hands, grasp rung and raise ladder, turning their bodies under it while raising, thus facing the heel of the ladder.

(e) Both men then walk toward the heel of the ladder, pushing upward on the rail hand-over-hand, until ladder is in an upright position. All men should watch the top of the ladder.

(f) No. 1 on the building side and No. 2 on the outside steady the ladder while No. 3 raises the fly. No. 1 then steps back, allowing the ladder to lean slightly toward the building to counteract the strain made by pulling on the fly rope.

(g) No. 1 man locks the dogs by pulling down on the rope from the under side.

(h) The ladder is then eased against the building by all three men, while each of the two men on the outside places his inside foot on the lowest rung to steady it.

(i) To lower the ladder, reverse procedure.

2.35 The 10-foot collapsible ladder is especially useful for inside work, for openings in debris, or in below-surface voids where ordinary ladders are cumbersome. To open a collapsible ladder, place it in a vertical position, grasp each rail, and push them apart.

2.36 The 12-foot roof ladder has two hooks mounted on movable sockets which permit them to fold inward when not in use. Placed over roof

peaks, ledges, sills, walls, or openings these hooks make the ladder safe and reliable, whether or not the heel rests on a solid footing.

2.37 In climbing ladders perfect rhythm is essential. To acquire this rhythm, step on every rung and grasp alternate rungs while ascending. Never climb with the hands on the rails of the ladder unless you are carrying a heavy object. Climb near the center of the rungs on the balls of the feet, and keep the upper part of the body at arm's length from the ladder. Always look toward the top, not the bottom. Never run up or down a ladder, but climb briskly, steadily, and smoothly.

2.38 When necessary to work from a ladder, use a leg lock for safety. (See fig. 26.) To do this, pass the foot opposite the working side over the second rung above the one on which you are standing. Then pass the foot back to the rail.

2.39 If extension ladders are not available, lash two ladders together to reach a desired height.



FIGURE 26.—Ladder leg lock.

When joining them, lash the rails together, not the rungs, placing two lashings on each side. Separate ropes should be used on each tie. Make each lashing snug and tight, using a clove hitch with an overhand knot as a binder. If possible, the rails of one ladder should fit snugly between the rails of the other. (See fig. 27.)

## LIFTING DEVICES

### LEVERS

2.40 The simplest lifting device used in rescue work is the lever or pry bar. Squadmen will use levers of various lengths and of several types. The force a man must exert on a bar to lift a load (and the mechanical advantage he gains by using the bar) depends on the ratio of his distance from the pivot and the distance of the load from the pivot. For example, if he applies force on a bar 10 feet from the load and the pivot is 1 foot from the load, the man gains a 9-to-1 advantage. His advantage increases or decreases as the pivot is moved toward or away from the load.

2.41 Thus, as illustrated in figure 28, distance AC is 10 feet. Pivot B is 1 foot from the center of the weight W. If the weight is 720 pounds, the man must exert a force of 80 pounds on the bar to lift the weight. Mathematically, the problem is solved by the following proportion:

$$\text{LOAD/FORCE} = \text{BC/AB}$$

$$720/F = 9/1$$

$$9F = 720$$

$$F = 80$$

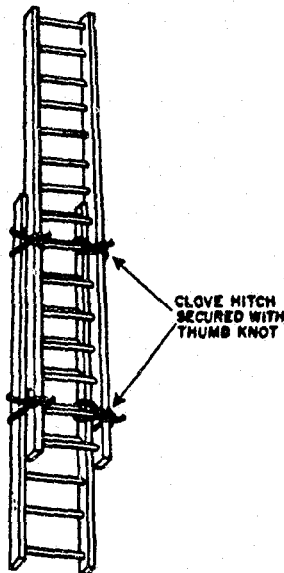

FIGURE 27.—Lashing ladders for additional length.

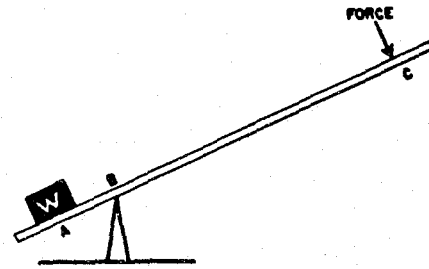

FIGURE 28.—Lever force exerted downward or upward.

2.42 The pivot or fulcrum must be of material that will not slip or crumble. If a metal beam is being lifted with a metal bar, place a piece of wood between the bar and the beam so the beam will not slip.

2.43 Loads should be blocked up as they are lifted to take the weight off the bar, or to obtain an additional mechanical hold to lift the weight higher.

### JACKS

2.44 Jacks are used in lifting heavy loads and are of three general types:

(a) *Ratchet*.—A simple jack which raises a load by means of a lever working against a ratchet which supports the load between each lifting stroke of the lever. Ratchet jacks are simple in construction, and are manufactured in various sizes and lifting capacities. They will be used frequently in rescue work. Recommended heavy rescue equipment (par. 2.9) includes two ratchet jacks of 5-ton capacity, and two of 15-ton capacity.

(b) *Screw*.—A simple jack operated by means of a lever which rotates a screw, which in turn raises the load. The screw jack is probably the safest type since all danger of slip-back is eliminated. Recommended rescue equipment includes two 5-ton screw jacks.

(c) *Hydraulic*.—This jack is operated by means of the resistance offered when a liquid, usually oil, is forced through a small opening to move a plunger and raise the load. It is useful since it can be made to lift heavy weights and is not unwieldy. However, the load should not be allowed to rest on a hydraulic jack for any appreciable length of time, since the jack may leak and allow the load to drop.

2.45 For safe and efficient use of jacks, the following rules should be observed:

(a) Under a load, a jack should stand squarely on a heavy timber or other substantial footing to prevent its slipping or sinking into the ground.

The footing must be dry and free from grease so the jack will not slip.

(b) As the weight is lifted, solid material supports should be placed under it to prevent damage if the jack should fail. The weight of raised sections of walls and floors should not be allowed to rest entirely on the jack while rescue workers crawl under. Cribs should be set under heavy weights or sections of floors to prevent settling after lifting operation is completed. Cribbing can be done with timbers of various sizes ranging from 2 to 8 feet in length, depending on the weight to be supported and the available working space. Be sure that the ground is level at the point where the crib is to be set. (It is better to level off high spots than to fill in low ones.) The crosstie crib (fig. 29) will see frequent use, since it is a safe method of supporting heavy weights. Space several timbers well apart and parallel, then put another level of timbers on top of and at right angles to the ones on the first level. Each added level is at right angles to the one below it. The number of layers needed will depend on how high the load is to be lifted.

(c) Jacks should be inspected and tested regularly. They should be kept clean, with working parts well oiled and greased.

(d) When using several jacks under one load, be sure all jacks lift or lower together so that the load will not tip nor put too much weight on one jack.

(e) When jacking a metal object, be sure that a wood plank is placed between the jack and the object to prevent slipping.

(f) Be sure the "up" and "down" latch dogs are not cracked on ratchet jacks.

(g) Be sure the jack handle fits the handle socket.

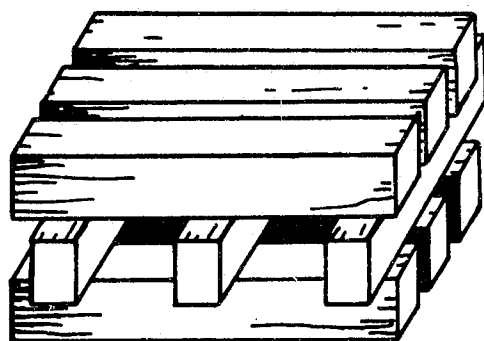

FIGURE 29.—Crosstie crib.

(h) Always remove the jack handle when it is not in use.

(i) Since the base of a jack is small, comparatively, use a plank or board to obtain a greater bearing surface.

### BLOCK AND TACKLE

2.46 Another lifting device used to raise or move heavy weights, beams, sections of floors, and heavy timbers is the block and tackle. Like levers and jacks, this device provides a mechanical advantage, enabling rescue workers to overcome otherwise immovable obstructions. Single, double, and triple sheave blocks, as well as snatch blocks, will be used, depending on the job to be done. A block is composed of a frame made either of wood or metal, and a wheel or sheave, usually made of steel or hard wood.

2.47 The following is standard block and tackle terminology:

(a) *Block*.—A grooved pulley or sheave in a frame or shell provided with a hook or strap by which it may be attached to another object (fig. 30).

(b) *Tackle*.—An assemblage of ropes and pulleys arranged for hoisting or pulling.

(c) *Pulley or sheave*.—A grooved wheel held in the frame over which ropes must pass.

(d) *Snatch block*.—A single block with an opening or gate on one side through which a rope can be inserted or "snatched" into the sheave without threading the end through (fig. 31).

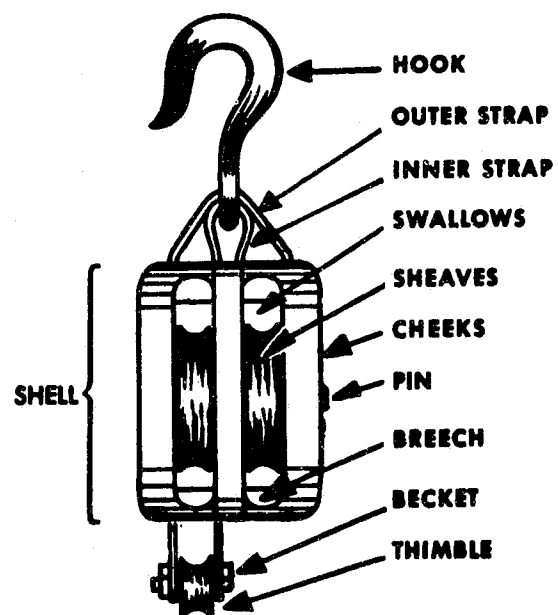

FIGURE 30.—Block or pulley in a shell.



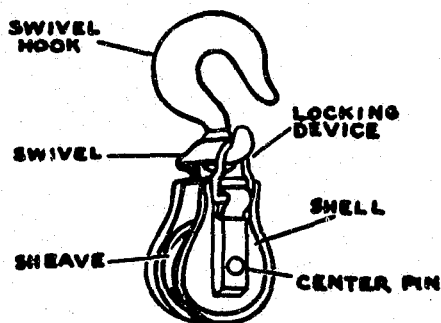

FIGURE 31.—Snatch block.

(e) *Frame or shell.*—The part of the block which holds the sheave, and to which the strap, hook, or ring is attached.

(f) *Strap.*—The part to which a hook is attached.

(g) *Standing block.*—The block fastened to the support from which the load is being moved, when more than one block is necessary.

(h) *Running block.*—The block attached to the object to be moved when more than one block is necessary.

(i) *Overhauling the blocks.*—Process of separating two blocks a desired distance (at least the distance the load is to be moved) before attaching the running block to the load.

(j) *Running in the blocks.*—The process of bringing the blocks closer together in a lifting or moving operation.

(k) *Chock-a-block.*—When two blocks have been run in as far as they can possibly go.

(l) *Becket or ring.*—Metal ring fastened to block for attaching rope or chain.

(m) *Standing end of tackle.*—End of rope fixed to the block at the becket.

(n) *Running end of tackle.*—End of rope on which the pull is exerted.

(o) *Reeving the tackle.*—Process of passing rope over sheaves of a block in proper order.

(p) *Mousing of hook.*—Cord or marline tied across jaws of hook to prevent rope or sling from jumping out (fig. 32).

(q) *Twisting of the tackle.*—A motion of the tackle during pulling usually caused by a peculiar lay in the rope.

(r) *Returns.*—Moving sections of rope between blocks.

(s) *Power gain, or mechanical advantage.*—Increase in lifting or moving capacity gained by using the block and tackle.

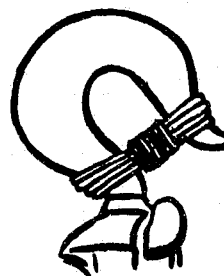

FIGURE 32.—Mousing of hook.

(t) *Heave.*—Signal for members of the team to exert pull on rope; also the act of pulling.

(u) *Gain.*—Distance the weight is lifted or moved.

### CARE AND USE OF BLOCK AND TACKLE

2.48 For care of rope which is assembled as the tackle, see paragraph 2.14. Blocks and sheaves should be inspected for flaws regularly. The bushings should be well greased. Be sure, however, that grease or oil does not get on the rope.

2.49 Twisting of the tackle, especially if the rope is new, is hard to prevent. The force required to lift a load almost doubles if the rope has one complete twist. Further, there is the danger of a heavy load breaking loose and injuring the workers. The twisting is due to the lay of the rope. There is no special method of reeving which will prevent it, although with a new rope, stretching will help.

2.50 During a lifting or moving operation the tackle may be prevented from twisting by insertion of a pick handle or crowbar through a knot at the fixed end of the rope, and at right angles to and between the returns. The pick handle can be controlled with a lightweight rope used as a guy and tied to one end of the pick handle by a clove hitch. (See fig. 33.)

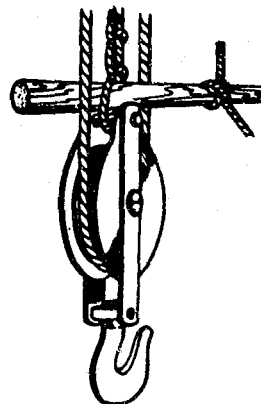

FIGURE 33.—Method of preventing tackle from twisting.

**REEVING A TACKLE**

2.51 To "rope up" or reeve a tackle, lay blocks about 3 feet apart, hooks out, so one is horizontal and the other vertical. For sequence of steps, follow numbers in figures 34, 35, and 36.

**GAIN IN POWER**

2.52. A block is named from the number of sheaves it contains, and the number of sheaves determines the power gain. (See fig. 37.) Generally, the weight that can be lifted is equal to the applied force times the number of ropes leaving the movable block. For example, if a man can exert a force of 120 pounds on the pull line

of a 3-sheave tackle, he will lift 6 times 120 pounds, or 720 pounds.

2.53 The rescue worker must be able to determine the length of rope required for a set of blocks and tackle to lift a weight a given height. He can determine this length by multiplying the total number of sheaves in both blocks plus 1, by the height which the weight is to be lifted plus the distance measured from the top of 1 sheave to the bottom of the other sheave when chock-a-block. For example, to raise a load 30 feet with a 3- and 2-sheave block, at 4 feet when chock-a-block, 204 feet of rope are necessary. The latter figure was computed by  $(5+1)(30+4)$  or  $6 \times 34 = 204$ .

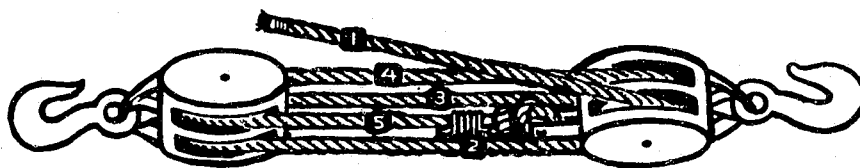

FIGURE 34.—Double and double reeving.

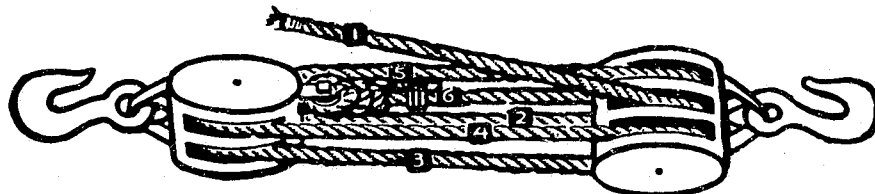

FIGURE 35.—Triple and double reeving.

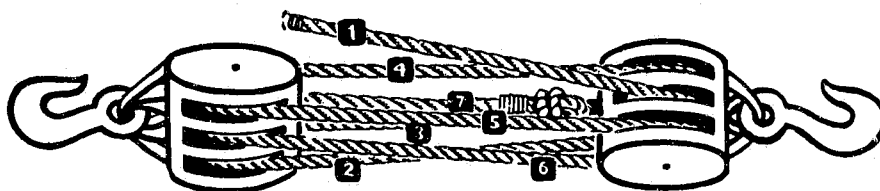
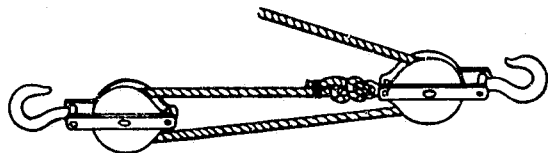
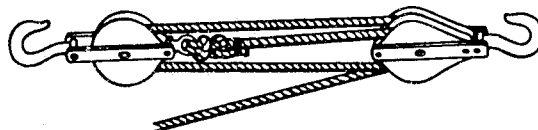

FIGURE 36.—Triple and triple reeving.



power gain—2



power gain—3

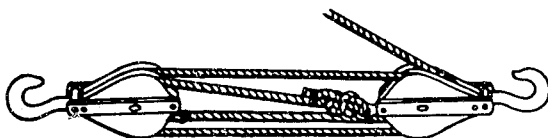

power gain—4

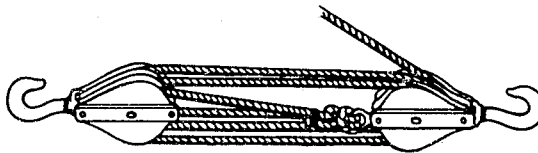

power gain—6

FIGURE 37.—Tackle combinations and power gains.

## PRECAUTIONS

2.54 In using block and tackle, the following safety precautions should be observed:

(a) Always check blocks and sheaves to see that they are in good condition. Keep them clean and the bushings well greased.

(b) Be sure the tackle used is the right size rope for the block.

(c) Be sure the tackle used is the right size rope for the weight to be lifted. (See table 1, par. 2.12.)

(d) When pulling on a line, everyone should exert a steady pull simultaneously. Only the leader in charge should give orders. On the heave, all should pull together, and hold onto the gain.

(e) When lifting a load, be sure the support holding the top block will hold the load, as well as the pull.

(f) To prevent wear on the rope, be sure to pull in a direct line with the sheaves. Whenever possible, the pull should be downhill.

(g) All those pulling should stand so they will not be in danger if the tackle or support should fail.

(h) Easing off on a suspended weight should be done gradually and without jerking.

(i) When several men are pulling on a line, they should work alternately on opposite sides of the rope to keep it in a straight line.

(j) Never use wire rope on a block with sheaves designed for manila rope, and vice versa.

## OTHER LIFTING DEVICES

2.55 Chain hoists also will be useful. These may be found on wreckers or tow cars. Generally, they are used for raising and lowering weights. They depend on the gear ratio of the hoist mechanism for the ratio of the weight lifted to the required pull on the lifting chain. Chain hoists may be difficult to operate at night and are not practical for use in a horizontal pull.

2.56 Gear-lifting tackle, employing a gear train with a handle and ratchet, is valuable in rescue work. It can be used on both vertical and horizontal pulls, and does not have lengths of loose chain to become entangled. It may be set up faster than block and tackle and requires less space to operate.

2.57 Winches on tow trucks, wreckers, and rescue service trucks will be useful, especially when walls must be pulled down. Also, with snatch

blocks, a winch can be used to advantage in lifting heavy weights.

## PROTECTIVE BREATHING EQUIPMENT

2.58 A bombing attack on modern cities may cause the release of gases in mains, sewers, refrigeration plants, and other industrial installations. Irritant and toxic mixtures of these gases can become hazards and create serious difficulties for rescue workers. In addition, fires, heavy smoke, and dust will make it impossible to conduct rescue operations in safety unless squadmen are provided with personal protection from these hazards.

2.59 For protection, rescue squads will use at least two types of masks:

(a) Filter mask.

(b) Self-contained breathing apparatus.

### FILTER-TYPE MASK

2.60 Recommended rescue squad equipment includes four filter type masks, using permissible universal canisters. As the wearer inhales, atmospheric air is filtered through the canister where dust, gases, and other impurities are removed.<sup>2</sup> **THIS MASK DOES NOT PROVIDE OXYGEN, AND SHOULD NEVER BE WORN WHEN THE OXYGEN CONTENT OF THE AIR IS LESS THAN 16 PERCENT—THE AMOUNT NECESSARY TO SUSTAIN LIFE.** (See par. 2.62.)

2.61 As the purified air leaves the canister, it is drawn through a corrugated tube into the facepiece, where it passes over the lenses before it is inhaled.<sup>3</sup> Upon exhalation, the air leaves the facepiece through a valve. A check valve prevents rebreathing exhaled air.

### SELF-CONTAINED BREATHING APPARATUS

2.62 Recommended heavy rescue squad equipment includes self-contained breathing apparatus. These operate independently of outside air and can be used in heavy concentrations (when oxygen content of the air is below 16 percent) of toxic gases, vapors, and carbon monoxide.

2.63 In the self-generating oxygen mask, as the wearer exhales, the exhalation flows from the facepiece through the right-hand breathing tube, into the center tube of the canister to the bottom of the canister. It then passes through the chemical

<sup>2</sup> Harmful gases and vapors removed from the air by this canister are listed on the canister label.

<sup>3</sup> A nose clip and mouthpiece are not required with this mask.

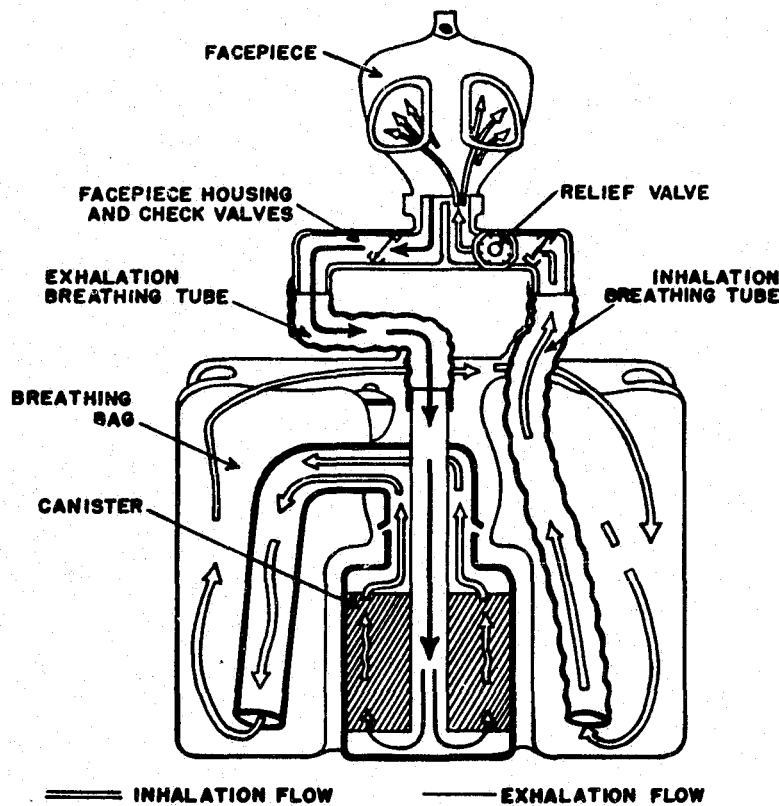

FIGURE 38.—Flow diagram of self-contained breathing apparatus.

which absorbs the carbon dioxide and moisture, liberating oxygen from the chemical. The oxygen flows up through the top of the canister to the bottom of the right side of the breathing bag, then to the left side of the breathing bag and into the facepiece through the left-hand breathing tube. (See fig. 38.)

### DEMAND BREATHING APPARATUS

2.64 The demand breathing apparatus is a self-contained apparatus for use in toxic or oxygen-deficient atmospheres. It gives respiratory protection during strenuous physical exertion.

2.65 The demand apparatus can be either an oxygen or air unit, as the user prefers. The choice is governed to a large extent by the type of breathing gas available in the area. If an air apparatus is selected, only certified pure air should be used for refilling the cylinder. The parts of the masks are—

(a) A facepiece assembly consisting of a facepiece with headbands, an exhalation valve, and breathing tubes.

(b) A demand regulator which reduces the high-pressure gas to a breathable pressure and

supplies the wearer in direct response to his breathing requirements.

(c) A flexible hose which conducts the high pressure gas from the cylinder to the demand regulator.

(d) A cylinder which is the reservoir for the supply of compressed breathing gas.

(e) A back plate upon which the cylinder is mounted, and a heavy-duty harness by which the entire apparatus is worn.

### SPECIAL PRECAUTIONS

2.66 Special precautions are necessary in the use of protective breathing equipment where the presence of chemical warfare agents is suspected. Immediate use of protective masks (and impermeable clothing in case of liquid nerve gas) is important. A canister-type mask developed by the Federal Government, CD V-800, will protect the eyes, nose, and respiratory tract against all known chemical and biological warfare agents.

### TRAINING

2.67 The rescue worker must realize that protective breathing equipment is provided for his

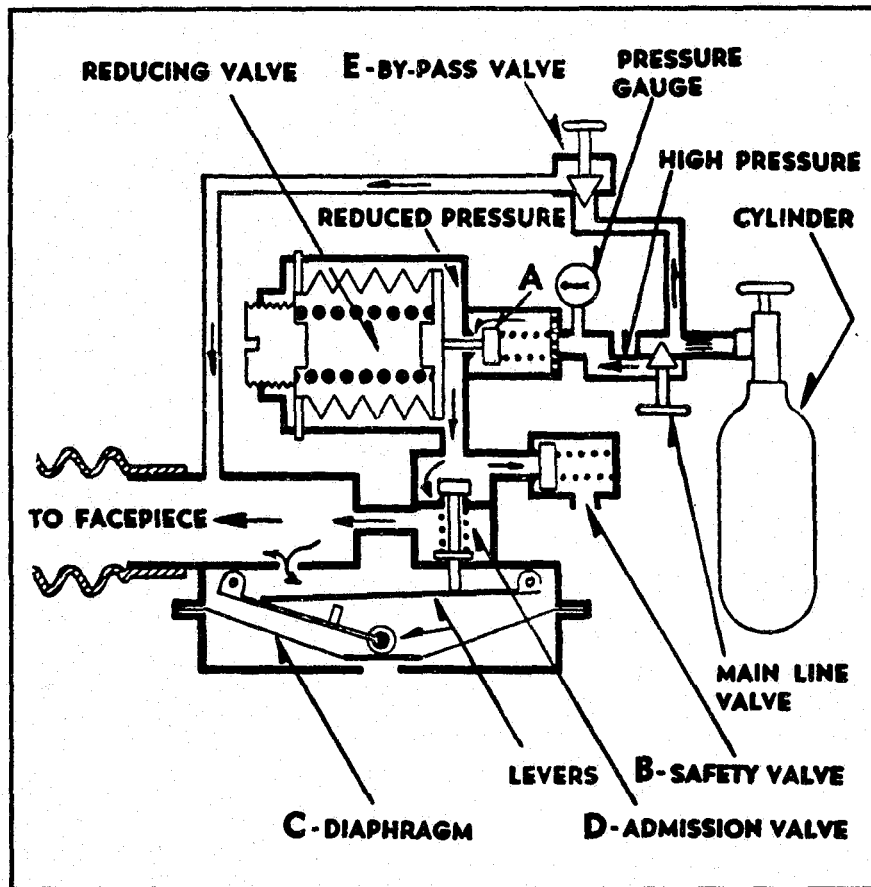

FIGURE 39.—Flow diagram of demand breathing apparatus.

personal safety. His life may depend on his training in the use of this equipment, his knowledge of its limitations, and the care that he gives it. Each squadman should be thoroughly familiar with the particular type of equipment used by his squad. He should follow the instructions of the manufacturer for proper fitting of the mask, testing for tightness, replacement of the canister, care and maintenance, and proper equipment terminology.

2.68 Regular training, especially under simulated rescue conditions, will instill confidence. Learning to wear and work in such equipment is not difficult if the wearer understands its limitations and has confidence in it. The rescue worker should first learn to walk with the equipment on, then climb stairs, and gradually progress to more strenuous activities such as sawing a board or using a shovel. In this way he will become accustomed to breathing restrictions and learn to work in relative comfort without becoming quickly exhausted.

2.69 Rescue workers should not over-exert

while working or training with protective breathing equipment. The leader is responsible for observing the condition of his men, and providing for their relief, especially during strenuous operations.

#### USE OF LIFELINE

2.70 Before entering a toxic atmosphere with a mask, a worker should attach a lifeline by a bowline under one arm and over the shoulder. This will enable him to remain in contact with a person in fresh air by sending and receiving rope signals. The lifeline should be kept taut to transmit signals properly. Standard rope signals are:

- (a) 1 pull.—Stop (if traveling), OK (if at rest).
- (b) 2 pulls.—Advance.
- (c) 3 pulls.—Retreat, come out at once (from the outside).
- (d) 4 pulls.—Distress, need help.

2.71 At least two persons should work together. One should remain in the fresh air while the other enters. The person in fresh air should be ready

to don his mask and enter the toxic area to assist the other should he need help. When two persons work in a toxic atmosphere, a third person should remain behind in fresh air, equipped and prepared to go to the assistance of the others.

## **CUTTING TOOLS**

2.72 Rescue workers may have to cut through heavy wood or iron beams and steel girders, or force openings in masonry walls and concrete floors. In addition to bolt cutters, pipe cutters, and hand and power saws, heavy rescue squad equipment includes an oxygen acetylene cutting outfit.

2.73 An oxygen acetylene cutting torch operator should have training and practice in the use of this tool, since it is dangerous if not properly handled.

2.74 Suitable goggles should be worn by the operator to protect him from sparks, flying embers, and glare. The torch should be lighted with the striker provided. In handling the torch, the operator must make sure that in turning the flame away from the work, he is not turning it on a fellow worker. The rubber hose, like most of the cutting apparatus, must not be exposed to heat, sparks, oil, or grease. These materials can be easily set afire by oxygen under pressure, injuring rescue personnel and equipment and disrupting operations.

2.75 The proper flame for cutting is attained by adjusting the valves on the torch. The two inner flames visible in the cone should be adjusted to become one. The metal to be cut is then preheated until it becomes cherry red in color. Preheat by holding the torch about one-sixteenth inch away from the metal. When properly heated, move the torch about one-half inch farther away from the metal, slowly depress the high pressure oxygen valve on the torch, and cut.

2.76 When cutting in a confined place, be sure that ventilation is provided, and that fire precautions are observed. If cutting near trapped persons, protect them from the flame, sparks, fumes, and glare by using asbestos blankets or some other means such as tarpaulins soaked in water. The operator must be especially careful that explosive fumes and gases are not present and that the torch does not ignite combustible materials. Fire extinguishing equipment should be immediately available.

2.77 Objects to be cut must be braced so they will not fall on the victim, the operator, or other rescue workers. Further, rescue workers must be sure that in cutting a beam or support, they are not releasing additional debris, or allowing other portions of the structure to collapse on themselves or trapped persons. After each use, be sure before storing the equipment that all cylinders are filled and ready for use again.

## **TUNNELING AND DEBRIS REMOVAL TOOLS**

2.78 Recommended rescue squad equipment includes an assortment of shovels, picks, and sledge hammers which can be used in breaking through masonry walls and concrete floors. Although pavement breakers and pneumatic tools provide the quickest means of cutting through masonry, they are not normally part of rescue squad equipment and must be obtained from other sources. These tools must be used with extreme care because of vibration and dust which may be produced.

2.79 Metal baskets, boxes, and wheelbarrows will be used to carry away debris. In many cases, the debris may have to be carried some distance for proper disposal.

## **LIGHTING AND POWER EQUIPMENT**

2.80 For night operations and operations in darkened areas, emergency lighting equipment is essential not only to expedite the work, but also to increase safety. Recommended rescue squad equipment includes portable combination battery or generator-powered floodlights and safety-approved dry cell battery lights, as well as a portable gasoline-driven power unit.

2.81 Other types of lighting equipment, including generators, carbide lamps, and theater floodlights and spots, may be used if available. When using open flame for lighting make sure that gas is not escaping from mains or pipes and that explosive mixtures of fumes are not present, otherwise there could be a serious explosion.

## **EQUIPMENT AVAILABLE FROM OTHER SERVICES**

2.82 For some operations, rescue squads will require equipment not carried on rescue trucks. This equipment should be obtained from other services through the proper official.

2.83 Much of the required additional equip-

ment will be available from the engineering services. This includes bulldozers, cranes, loaders, dump trucks, pavement breakers and pneumatic tools, generators, draglines, and other heavy equipment. In many communities local industries possess items of equipment useful in rescue operations. Table 2 lists such equipment. By contacting these firms, civil defense officials can

usually arrange for its use by their organized rescue squads in time of emergency.

2.84 Trucks and other transportation may be obtained through the proper rescue official from the transportation services. Operators should be furnished with the equipment by the service supplying it. Assigned equipment and operators work under the rescue chief at the scene.

TABLE 2.—Industrial equipment useful in rescue

Equipment	Type of industry									
	Utilities	Manu- factur- ing	Con- struc- tion	Iron, steel	Mining	Public safety	Chem- ical	Petrole- um	Ship- yards	Trans- porta- tion
Gas detection, indicating, and recording instru- ments.....	X	X	X	X	X		X	X	X	X
Canister and hose masks.....	X	X	X	X	X	X			X	
Filter masks.....	X	X	X	X	X	X			X	
Telephone masks.....					X	X				
Oxygen breathing apparatus.....	X		X	X	X	X	X		X	
Self-rescuers.....					X					
Dust and air-line respirators.....		X	X	X	X			X	X	X
Dust respirators.....	X	X	X	X	X		X	X	X	X
Paint respirators.....		X	X	X				X		X
Metal fume respirators.....		X	X	X				X		X
Inhalators.....	X	X		X	X	X	X	X	X	
Artificial respiration trainers.....	X			X	X	X	X	X	X	
Air movers.....	X	X	X		X			X	X	
Welders' protective equipment.....	X	X	X	X	X		X		X	X
Goggles and eyeshields.....	X	X	X	X	X	X	X	X	X	X
Fire blankets.....		X					X	X	X	
Safety belts and steel safety tail lines.....	X		X	X			X	X		
Electric cap lamps.....	X		X		X	X	X	X		
Ear defenders.....		X	X							X
Electric hand lamps.....			X		X	X	X	X		
Protective hats.....	X	X	X	X	X	X	X	X	X	
Safety clothing.....	X	X	X	X	X		X	X		
Electric floodlamps.....	X		X		X	X		X	X	

## RESCUE TECHNIQUES

3.1 A rescue technique is one of the steps necessary to carry out a rescue operation. All rescue operations normally require the use of several techniques. Selection of the most effective techniques under the varying conditions of rescue work often means the difference between survival or death of a casualty. The major techniques described in this chapter are broken down into their various elements such as lashings, holdfasts, and slings, as essential in rigging operations; breaching walls, trenching, debris tunneling, and ventilation, as used in rescue from basements; and the raising and supporting of structural elements, useful in a variety of rescue operations. Casualty handling techniques are described in chapter 4.

### LASHINGS

3.2 Generally, lashings are used to bind two or more objects together. Squad members should understand and practice them until they become thoroughly proficient in their use. Suitable lashings can generally be made with a 50-foot length of  $\frac{1}{2}$ -inch rope.

#### SQUARE LASHING

3.3 Usually, this lashing is used to hold two poles together at right angles. (See fig. 40.) To make this lashing—

(a) Start with a clove hitch (a) around the standard below the ledger (crosshead) and wrap the long and short ends together (b). Then, take

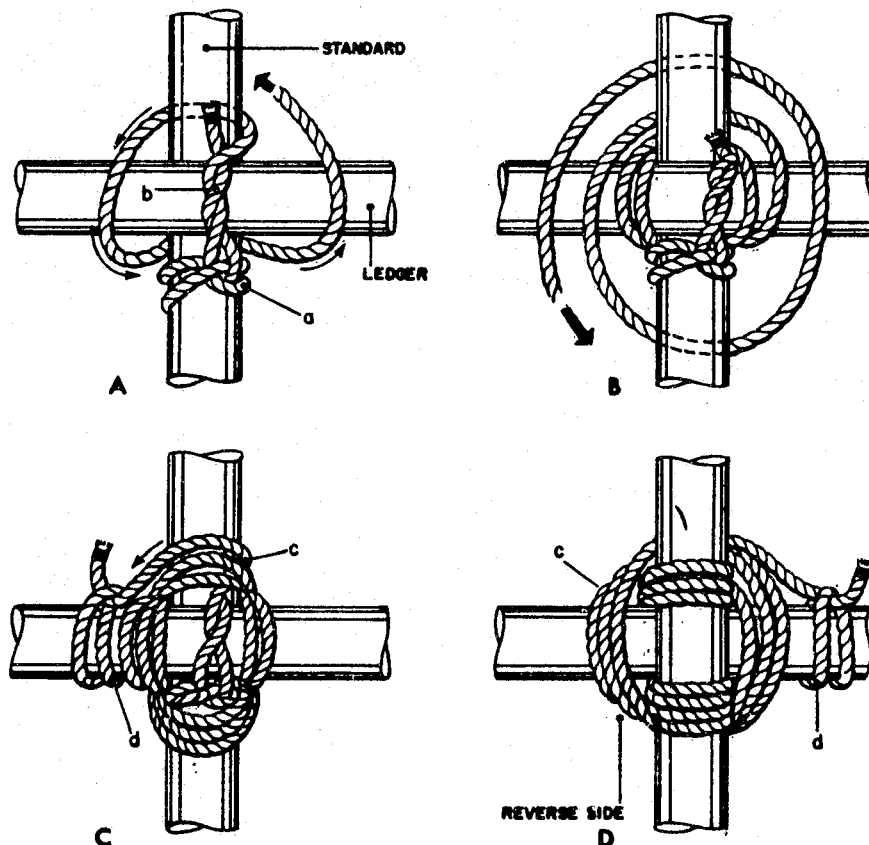

FIGURE 40.—Making square lashing.



the twisted ends up and around both standard and ledger (in the direction of arrow) above the clove hitch (A, fig. 40).

(b) Repeat this circuit 3 or 4 times (B, fig. 40), drawing the rope taut.

(c) Take four frapping turns (c) around the whole lashing between the spars (C, fig. 40), draw taut, and finish with a clove hitch (d) on the ledger. D, fig. 40 shows the square lashing viewed from the back.

### DIAGONAL LASHING

3.4 This lashing (see fig. 41) is used to bind together two poles or spars at an angle other than a right angle, especially where their method of use may cause them to spring apart. To make this lashing:

(a) Start with a timber hitch (a), then make four vertical turns (b), and draw taut (A, fig. 41).

(b) Make four horizontal turns (c) and draw taut (B, fig. 41).

(c) Put four frapping turns (d) over the lashing between the spars, draw taut, and finish with a clove hitch (e) (C, fig. 41).

### FIGURE-EIGHT LASHING

3.5 This lashing (see fig. 42) is used to bind three parallel poles together, as in forming a tripod. To make this lashing—

(a) Place three poles parallel on the ground. (If lashing a tripod, spacer blocks must be used and the center pole reversed as illustrated.) Start with a clove hitch on the nearest pole.

Then draw the rope under this pole, over the middle pole, and under and around the third pole.

(b) Continue the rope under the middle pole, over and around the first pole. Repeat these steps 10 or 12 times (A, fig. 42).

(c) Then make 3 to 4 frapping turns between the first and second pole (B, fig. 42), and between the second and third.

(d) Secure the lashing with a clove hitch on the third pole (C, fig. 42).

### ROUND LASHING

3.6 This lashing (see fig. 43) is used to bind two poles together, as in forming sheerlegs (A-frame). To make this lashing—

(a) Start with a clove hitch on one pole. (If forming sheerlegs, a spacer block must be used.)

(b) Continue with six close turns around both poles traveling upward (A, fig. 43).

(c) Make four frapping turns securing the lashing with a clove hitch on the opposite pole and at the bottom of the lashing (B, fig. 43).

### HOLDFASTS

3.7 Holdfasts are used in rigging to secure guy lines. They may be secured to reinforced concrete or metal standards, masonry, or metal framework of buildings. Other methods of anchoring lines may be improvised by wedging beams into position in street manholes, placing timbers across openings in buildings or between

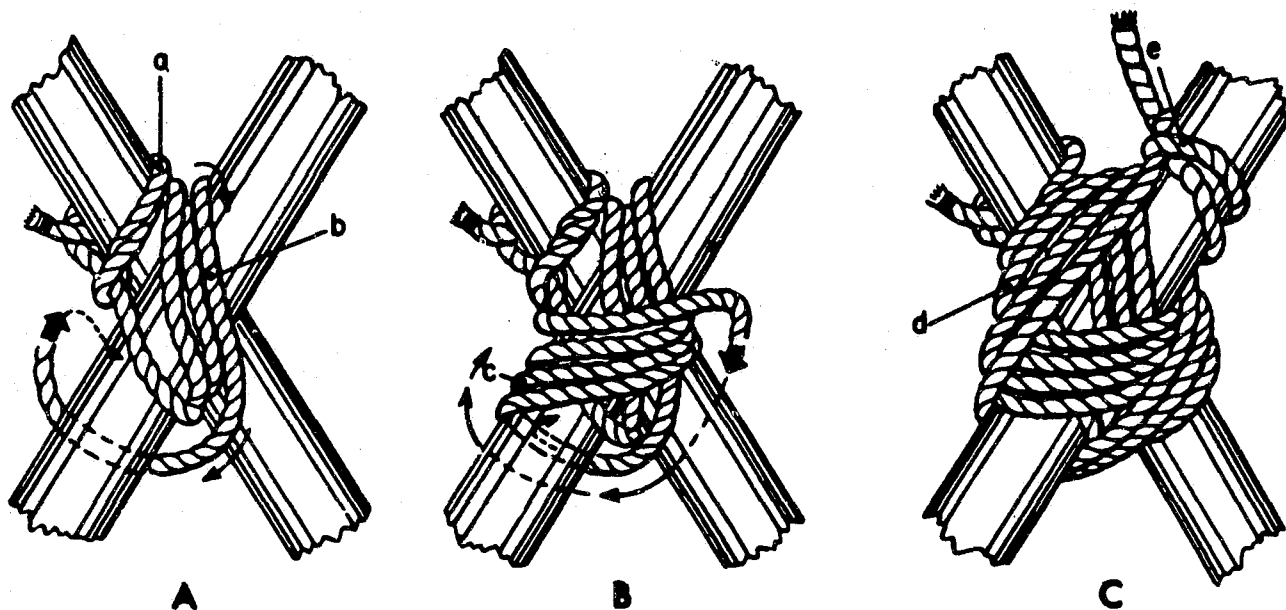

FIGURE 41.—Making diagonal lashing.

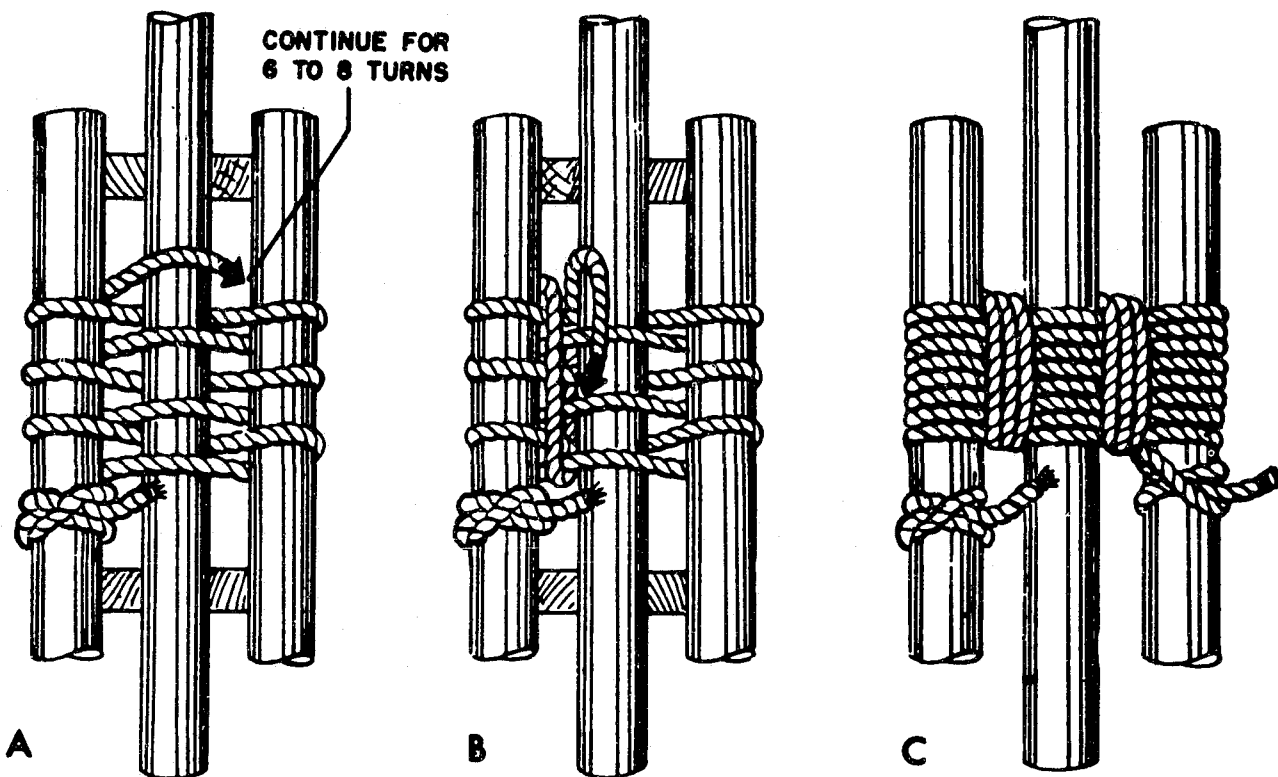

FIGURE 42.—Making figure-eight lashing.

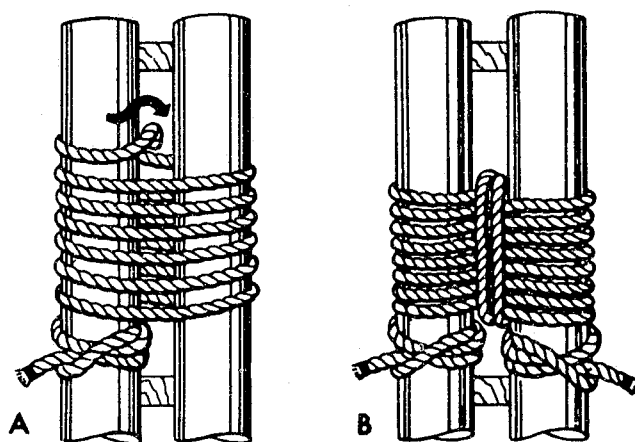

FIGURE 43.—Making round lashing.

buildings, or burying holdfasts (deadmen) and driving pickets.

3.8 The towing eye of the rescue truck or other heavy vehicle may make a satisfactory holdfast, provided the vehicle's brakes are dependable, and its wheels are blocked.

#### DEADMEN AND PICKETS

3.9 The deadman is a timber or pipe buried horizontally in a trench, at a right angle to the

pull. (See fig. 44.) Be sure the deadman is strong enough, and anchored securely enough, for the pull. Dig the trench just large enough for good bearing. The less the earth is disturbed the better the bearing surface. A deadman properly set and connected to guys may bear a load up to 5 tons. In most cases, 5 feet is a suitable length for a deadman. When deadmen are used with gin poles, they should be at least as thick as the pole. (See par. 3.17.)

3.10 Pickets are suitable for use as holdfasts in ordinary soil for pulls up to 2 tons. They may be used singly or in combinations. (See fig. 45). Pickets should be of sound wood, preferably ash or oak. They should be at least 5 feet long and 3 inches thick. If made of softer wood, they should be 4 inches thick. Steel fence posts of comparable cross-sectional holding area also may be used.

3.11 Picket holdfasts are easily constructed. Pickets should be driven into the ground perpendicular to the line of pull, with at least two-thirds of their length in the ground. A single picket holdfast can be reinforced by driving other pickets

behind it in line with the guy line at 3- to 6-foot intervals (A, fig. 45) and connecting these pickets with lashings as described in paragraph 3.13.

3.12 The combination picket holdfast is used to withstand very heavy pulls. For example, where a single picket can withstand about 700 pounds, the 1-1-1 combination will hold about 1,800 pounds, while the 3-2-1 combination can stand as much as 4,000 pounds. Small lashing lines linking each picket to the next divide the force of the pull, so the first picket does not bear the entire load. The 3-2-1 combination in B, figure 45 differs from the 1-1-1 combination in that three pickets are driven into the ground and

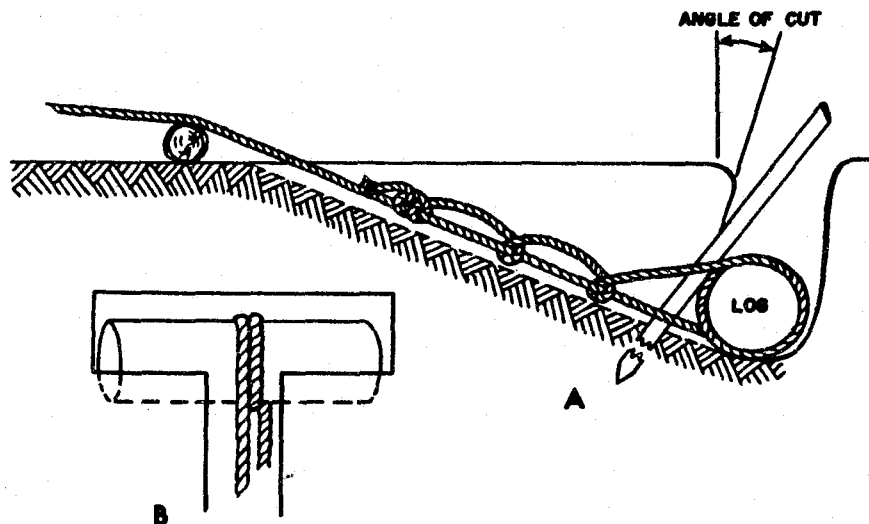

FIGURE 44.—Deadman holdfast.

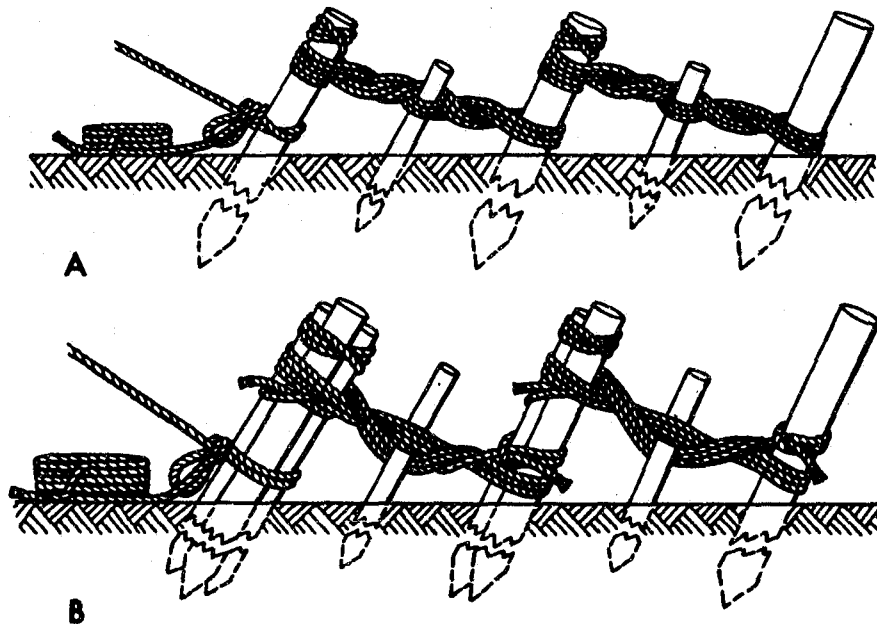

FIGURE 45.—Picket holdfasts.

lashed together before being used. Two pickets are used in the center group, and finally one behind the two.

3.13 To lash pickets—

(a) Start with a clove hitch near the top of the first picket.

(b) Make four to six turns around the first and second pickets, going from the top of the first to the bottom of the second.

(c) Repeat this procedure from the second to third picket and so on, until each picket is secured.

(d) Pass a sharpened stick through the turns of the lashing line, between each pair of pickets, and twist until the lashing is taut; then drive the stick into the ground.

3.14 On wet or soft earth, guys may be anchored to a timber supported by combination picket holdfasts. (See fig. 46.) Since it acts as a beam, the timber must bear evenly against the front row of pickets. The strength of this holdfast depends upon the strength of the timber and anchor line which must withstand the pull. This holdfast is called a combination log and picket holdfast.

3.15 Normally, the weakest part of a lifting rig is at the anchorage of the guy lines. Therefore, a man should be stationed at the holdfasts to keep a careful watch throughout an operation, since they may give an early indication of excessive strain on the guy or picket.

## RIGGING

3.16 Although timbers, poles, and iron pipes found at the scene of a rescue operation may be used to rig lifting and holding devices, squads should not depend solely on salvageable material. A supply of necessary items should be assembled and stored in areas where they can be made quickly available.

### GIN POLE

3.17 To lift medium loads, gin poles, or standing derricks, are constructed from a single pole or square timber which is tapered near the top to support lashing under load, and held nearly upright by guys secured to holdfasts. A block and tackle is lashed to the top of the pole, and the hauling part of the tackle leads through a snatch block at the base of the pole to the source of power. (See fig. 47.) The pole should be no longer than 60 times its thickness or it may buckle under a heavy load. A pole up to 40 feet in length can be erected by hand. Guy lines which anchor the pole should be of rope strong enough to stand the pull of at least one-half of the load to be lifted. (See table 1, ch. 2.) If the ground is level, guy lines generally should be anchored at least twice the length of the pole from its base. The angle of the pole will determine the amount of strain on the guys. For example, if the pole is almost vertical, the strain on the after guys is negligible. But when the pole is moved away from the vertical, the

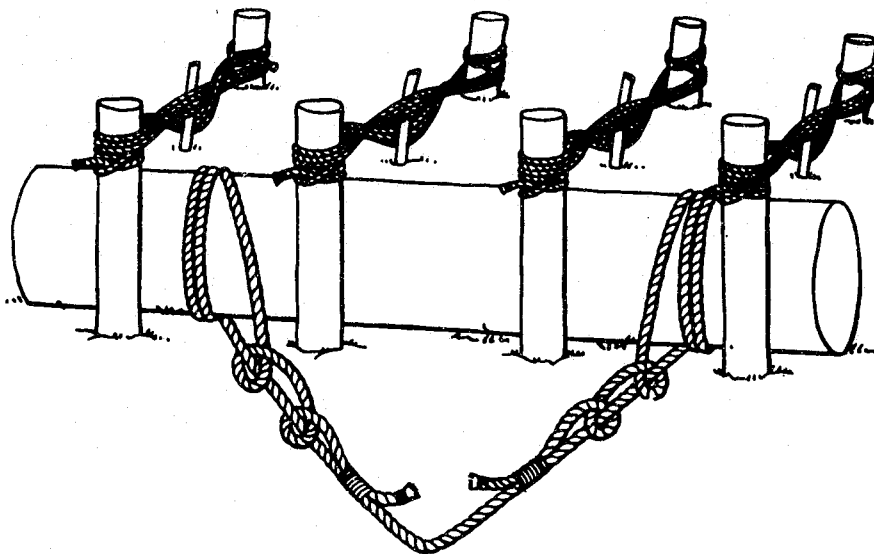

FIGURE 46.—Combination log and picket holdfast.

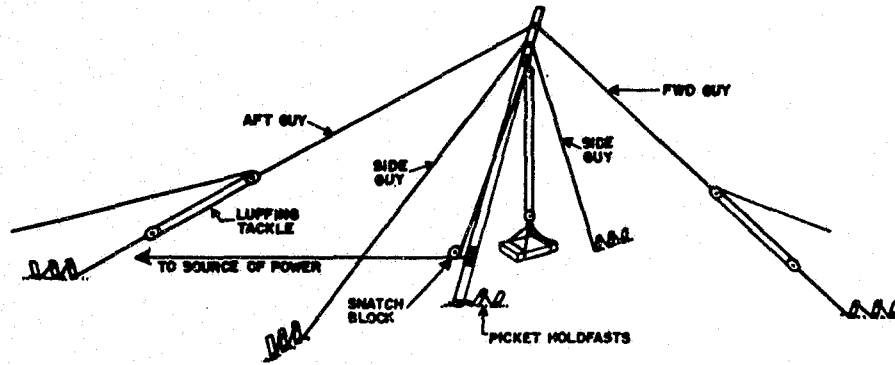

FIGURE 47.—Gin pole.

strain on the after guys increases proportionately.

3.18 To erect a gin pole, use the following procedure:

(a) Lash a crosspiece near the top of the pole with a square lashing. Lash a block and tackle to the pole with 8 or 9 turns so that the upper block will be suspended over the crosspiece and secure the ends with a square knot. Then slip the hook of the block under at least two turns and mouse it. (See fig. 48.)

(b) Lay the base of the pole at the spot where it is to be erected.

(c) Since each rope makes two guys lay out the guy ropes about four times as long as the pole. Using a clove hitch in the center of each, pass them over the top of the pole above the tackle lashing (A, fig. 48). After fastening, lead the guys from the poles to anchorage points opposite each other on the ground.

(d) Make another tight lashing 2 or 3 feet from base of the gin pole. Fasten and mouse a snatch

block at that lashing in same manner as the tackle block (B, fig. 48).

(e) Reeve the tackle so that the hauling part passes from the top block through the snatch block to the source of power.

(f) For the base of the pole, dig a hole 6 to 12 inches deep (depending on type of soil and weight to be lifted). Unless the ground is very firm, use short lengths of board as bearing plates for the pole.

(g) Set up a picket holdfast about 3 feet from the base of the pole and tie a line from the base of the pole to the holdfast. (See fig. 47.) This holdfast will keep the pole from skidding while being erected and will hold it in place while lifting the load.

(h) Secure the movable block to the pole near its base so it will be within reach when the pole is raised.

(i) Station a man at each guy anchorage to control the slack by turns around the anchorage as the pole is raised.

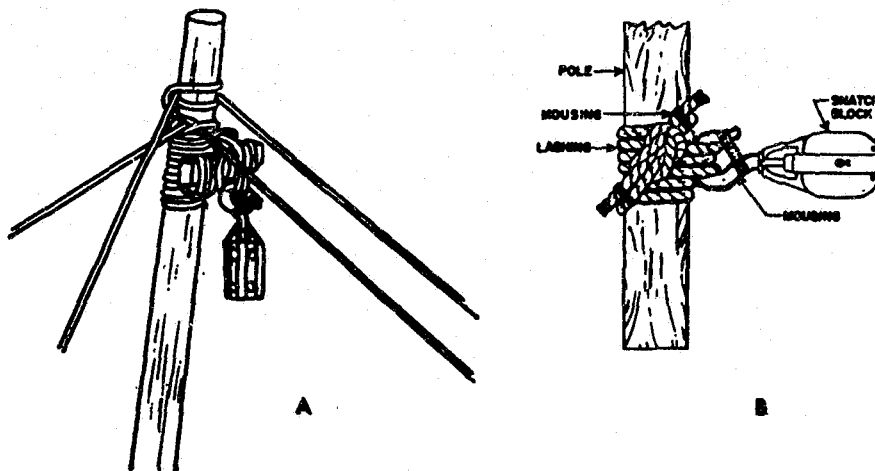

FIGURE 48.—Lashings.

A. Top lashing.

B. Base lashing.

(j) Raise the pole by hand to a height of 3 or 4 feet from the ground. Then tighten the after guys. Keep tension on the forward guys so the pole will not swing around and throw all its weight on one side. Continue to raise the pole until it is nearly vertical.

(k) Once the pole is upright, make all guys fast with two half hitches.

3.19 The top of the pole may be moved as much as 15° from vertical without moving the base. This is called drifting and should be done only when the pole is not loaded, unless it is possible to regulate the tension of all the guys by snubbing or by using luffing tackle that is secured to the end of each guy.

### SHEERLEGS (A-FRAMES)

3.20 For relatively heavy loads, usually where some horizontal movement of the load is desired, sheerlegs or A-frames are used. Horizontal movement is obtained by drifting. Sheerlegs are made by crossing two timbers, poles, pipes, or steel bars, lashing them together near the top, and suspending the hoisting tackle from the lashed intersection. (See fig. 49.) Quickly assembled and erected, sheerlegs require only two guys, and may be used effectively for working at a forward angle.

3.21 To erect sheerlegs, use the following procedure:

(a) Select two poles nearly the same length. Place them on the ground parallel, with their butts even, and lash near the top with a round lashing.

(b) Spread the butts until the distance between is about one-third of the distance from the butt to the lashing.

(c) To prevent the butts from spreading further, lash a line near the butt of each leg by a round turn and two half hitches, or secure each leg to a holdfast after the sheerlegs have been erected. A light board secured to the butt of each leg with nails or square lashings may also be used.

(d) After lashing the two poles, pass a line or wire rope between the V (at top of frame) and under it, to form a sling.

(e) Secure hoisting tackle to sling, and mouse hook. Be sure to tie a line to the hook of the movable block to pull the tackle within reach after the rig is set up. Otherwise it will not be possible to overhaul the tackle.

(f) Forward and after guys are required, similar to those for a gin pole. These should be made fast above the round lashing by clove hitches so the spars will tend to draw together when a load is applied. (Fasten the forward guy to the rear pole, and the after guy to the front pole.)

(g) The initial raising is done by hand, under the leader's direction. A man stationed at each picket controls a guy line. As the sheerlegs are raised, the after guy takes the strain and the forward guy is paid out. During erection, the guys are temporarily controlled with a round turn on the picket, and finally made fast with a round turn and two half hitches.

3.22 Bases should be set in holes about a foot deep to keep the legs from slipping. Unless the ground is very firm, short lengths of boards should be used as bearing plates to provide proper support.

3.23 Shorter timbers are more stable. Thus, timbers for light loads can safely be longer than the timbers used for heavy loads. A study of table 3 will show that the load-carrying capacities vary with the length and size of the timbers. The working capacity for each leg of an A-frame is computed as seven-eighths of the safe capacity listed below:

TABLE 3.—Load-carrying capabilities of timbers

Pole size (inches)	Length (feet)	Working capacity (tons)
6 x 6.....	20	5
	25	3
	30	2
8 x 8.....	25	7
	30	5
	40	3
	50	2
	20	20
10 x 10.....	25	15
	30	10
	40	6
	50	4
12 x 12.....	30	20
	40	12
	50	8
	60	6

3.24 Sheerlegs can be drifted forward during hoisting as far as 20° from the vertical. However, as the drift increases, stress on the legs as well as on the after guy increases. Thus, extra allowances must be made for drift.

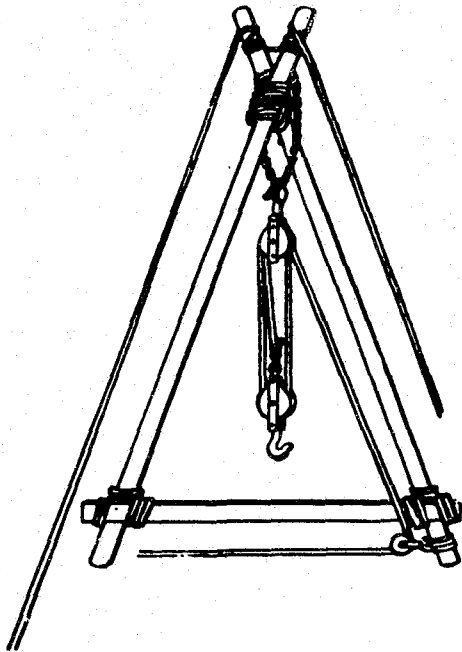

FIGURE 49.—Lashing and rigging sheerlegs.

3.25 A-frames are sometimes mounted on the back of trucks, such as auto wreckers. When hoisting, the wheels of the trucks should be blocked. Since they are usually constructed of pipe, the drift on truck-mounted A-frames can safely be a little more than  $20^\circ$ .

### TRIPOD

3.26 A tripod is used for loads heavier than those which can be handled by a gin pole or A-frame. It has three legs lashed at the top and does not require guy lines. (See fig. 50.) It can, however, lift loads only vertically. It requires comparatively little space, and is especially adaptable for use over holes in floors. The butts of the three poles should form an equilateral triangle on the ground. If the ground is soft, short boards should be used as bearing plates under each pole.

3.27 To erect a tripod use the following procedure:

(a) Place three poles, with their butts even, side by side on the ground. Support the tops of the poles a short distance off the ground.

(b) Mark the poles about 3 feet from the top of the shortest one to show the position of the center of the lashing. Then reverse the center pole so the marking is in the same place but the butt is in the opposite direction.

(c) Insert spacing pieces 2 to 3 inches thick between the poles. Then lash the poles with a figure-eight lashing. (See fig. 42.)

(d) Spread the butts of the two outer poles a distance about half that of the lashing to the butt with the top of the center pole resting in the crook of the other two. (See fig. 50.)

(e) Lift the head of the tripod as far as possible by hand and bring the center pole in to form an equilateral triangle.

(f) Continue to erect until the butts are evenly spaced half the height from the butt to the lashing. All poles must be on the same level to distribute the weight evenly.

(g) Center the tripod over the load. Secure the butts in position by one of the methods used on sheerlegs.

### JIB

3.28 A jib is a strong pole or timber with one end anchored down and the other projected over or from a support to allow hoisting or lowering by means of a tackle. (See fig. 51.)

3.29 The method used for securing, lashing down, or arranging the jib will depend on the situation, and the availability of suitable means of securing it. The jib may be projected over a sill or coping, resting on a timber to distribute the load, and kept in position by pads or blocks on either side, or it may be supported on a knife rest at a window opening, or slung from sheerlegs. Wherever it is erected, especially in damaged

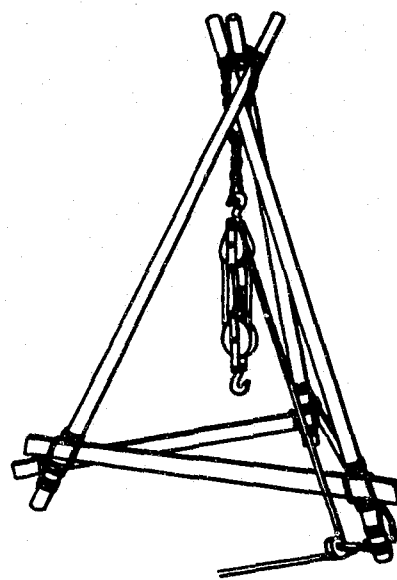

FIGURE 50.—Lashing and rigging tripod.

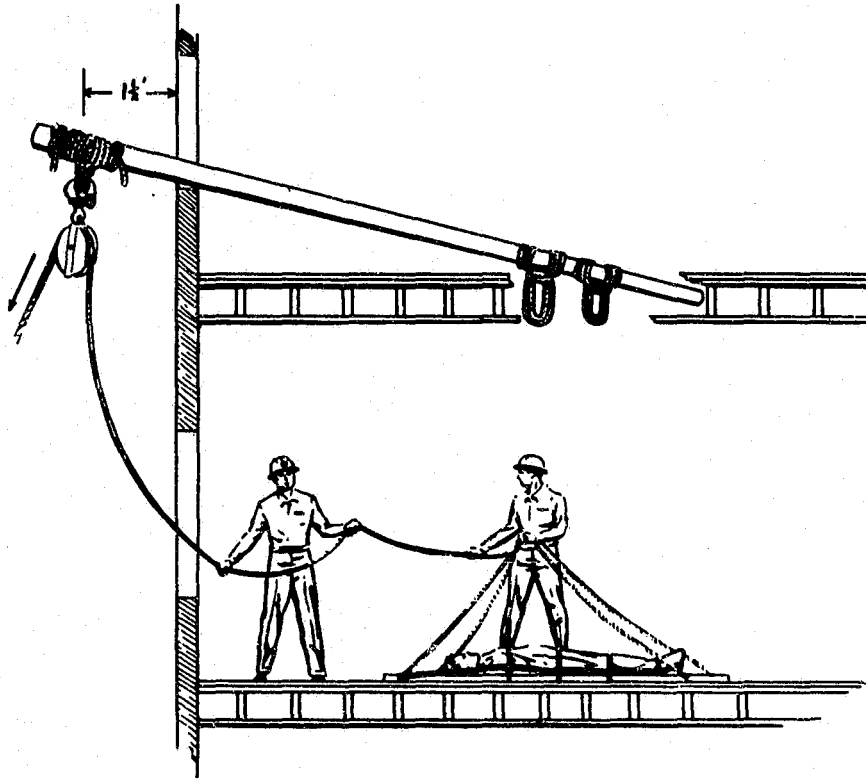

FIGURE 51.—Jib arm.

buildings, be sure the structure which supports it is safe. Sound copings and sills do not necessarily mean that there is a sound wall beneath them.

3.30 The tail of the jib pole should be firmly secured. Boards from wood floors can be removed allowing the tail to be lashed to joists. On concrete floors, a board can be placed over the tail, and enough debris or heavy objects piled on the board to counterbalance (with a margin of safety) the weight of the tackle and the weight to be lifted.

3.31 The projection of the jib over the support should be held to a minimum, as each additional inch of projection increases the leverage on the tail counterbalance.

3.32 Whenever possible, erect the jib on the floor above the one from which the load is to be lifted. This avoids interference and provides greater efficiency in raising and lowering loads. If a higher floor cannot be used, raise the jib on sheerlegs or other support to provide sufficient working height.

#### USE OF LADDERS IN RIGGING

3.33 Ladders may be used to rig gin poles and sheerlegs when suitable poles and timbers are not available.

#### LADDER GIN POLE

3.34 To erect a ladder gin pole:

(a) Attach a rope or sling around the rails near one end of the ladder to support a block and tackle.

(b) Fasten two guy lines to the ladder, one on each rail where the sling is secured.

(c) Raise the ladder to the desired position, and anchor the guy lines. (See fig. 52.) If necessary, anchor the ladder at the bottom to keep it from slipping.

#### LADDER SHEERLEGS

3.35 To erect sheerlegs with ladders:

(a) Place one ladder on top of another and lash the rails together loosely at one end.

(b) Turn the ladders on their rails and spread the unlashed ends to form a V.

(c) At the lashings, attach a sling to support the block and tackle, and fasten guy lines at the lashing around the rails on each side.

(d) Raise the ladders and anchor the guy lines. (See fig. 53.) If necessary, anchor the ladders at the bottom to prevent spreading.

3.36 Sheerlegs constructed with ladders cannot be drifted, and, like tripods, are restricted to vertical lifting.



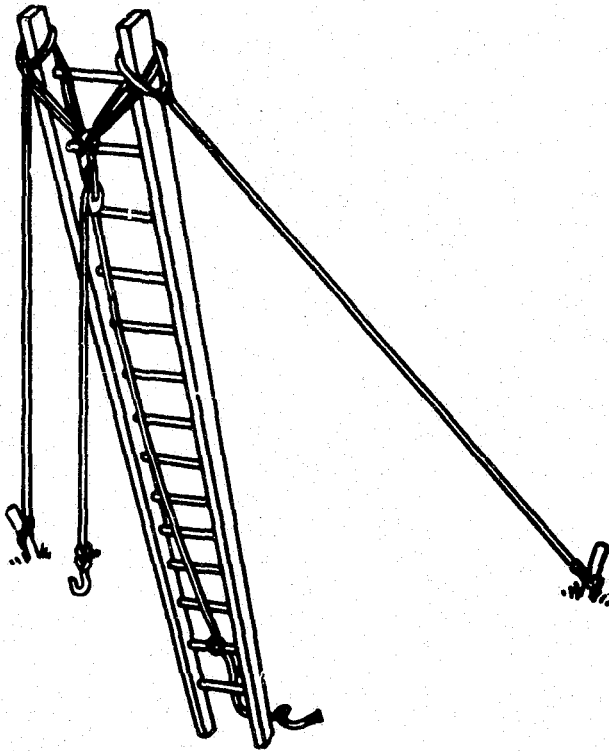

FIGURE 52.—Ladder gin pole.

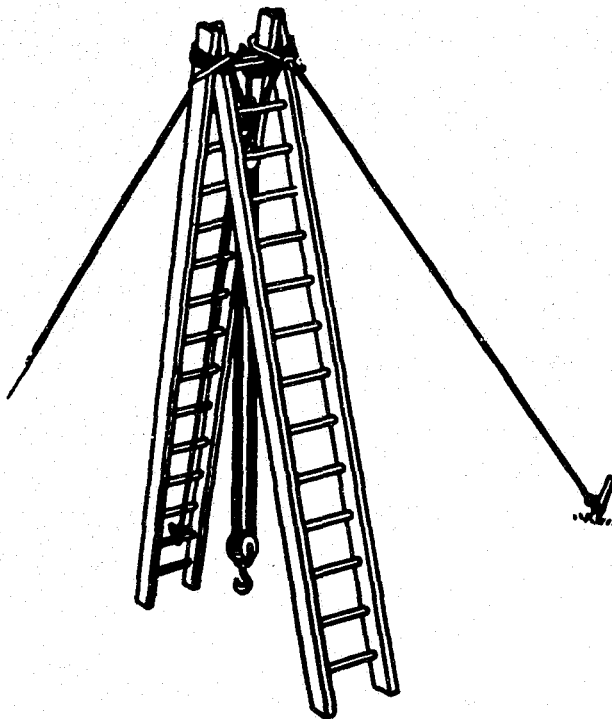

FIGURE 53.—Ladder sheerlegs.

## SLINGS

3.37 Objects to be lifted by various rigs must be properly secured to the movable block of the lifting tackle. Slings are used for this purpose. Wire rope and chains make the best slings, since they cannot be cut easily by sharp objects. Although slings of manila rope are easier to handle, they must be padded with burlap bags or similar materials if they are to be used safely to hold objects with sharp edges. Safety is the most important consideration in selecting materials for slings.

3.38 Usually, a chain will have a ring and hook, and can be secured around an object without difficulty. Wire rope slings should be equipped with an eye on both ends. Manila rope may be cut to the required length, and the sling formed by tying the ends together with a square knot.

## DEBRIS TUNNELING

3.39 Tunneling is a means used to reach casualties, usually when their location is known. It is slow, dangerous work, and should be undertaken only after all other methods have been exploited. It is used primarily for connecting existing voids. Tunneling should be carried out from the lowest possible level, should not be used for general search, and must not be aimless. Occasionally, however, tunneling may be used to reach a point, such as a void under a floor where further search is to be conducted. (See fig. 54.)

3.40 A tunnel must be of sufficient size to permit rescuers to bring out casualties. It should not be constructed with abrupt turns. Tunnels as small as 30 inches wide and 36 inches high have proved satisfactory for rescue work. Whenever possible, tunnels should be driven along a wall, or between a wall and a concrete floor, to simplify the framing required.

3.41 Constructing a vertical shaft may be considered a form of tunneling for vertical or diagonal access. Usually these shafts are made through earth after debris has been cleared from the surface. They are often made to reach a point where a basement wall must be breached. Shafts should not be sunk where water or gas service lines enter buildings. Strata of soil or gravel carrying water should also be avoided.

3.42 Service gas pipes, water lines, and buried electric conduits may be encountered. Avoid cutting these lines. If it must be done, seal the ends.

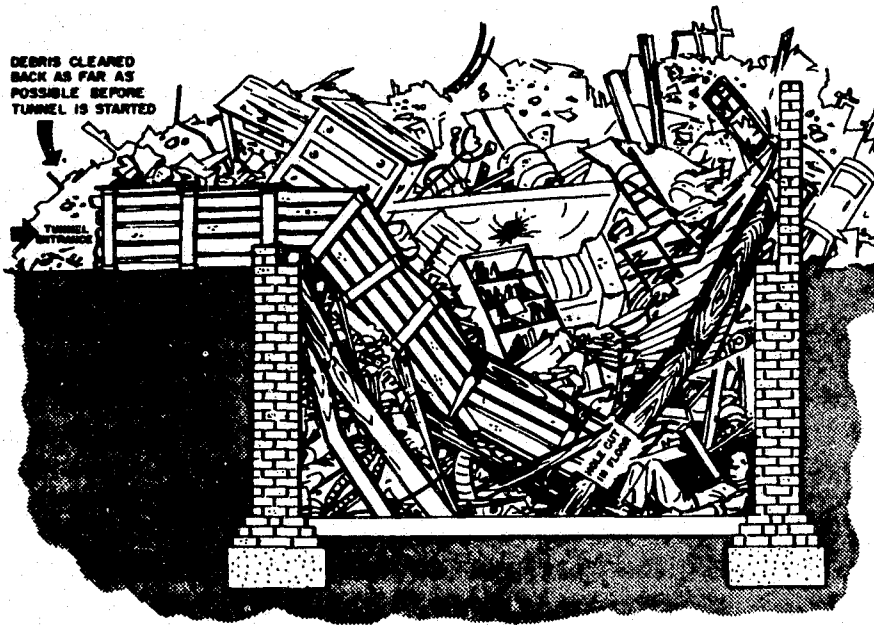

FIGURE 54.—Tunneling to reach void.

Water pipes may be sealed with wooden plugs. Pressure in gas lines usually is lower, and may be stopped with moist clay or a wad of rags. If workers from utility companies are available, let them work on these service lines. On gas or water lines of 3 inches or more, pressure may be so great they should not be cut, since it may not be possible to plug them unless the mains are shut off. It may not be advisable to shut off a water main, since it may interrupt the water supply for fire fighting. Heavy underground electric lines should be cut by a utility crew from the engineering services. All electric lines encountered should be regarded as live until proved otherwise.

3.43 Debris tunneling is quite different from tunneling through undisturbed earth, although strutting and bracing are necessary in both methods. The speed at which a debris tunnel can be constructed varies with the nature of the debris and the size and shape required. Because debris is unstable and key beams have to be left in place, the shape and path of a tunnel through debris is often irregular. Thus, a definite pattern of timbering, as in a tunnel through earth, may not be possible.

3.44 The size of timbers used for bracing is governed by the nature of the job and the equipment and material available. It is always better to use timbers which are too heavy than those which are too light, because of the uncertain weight which they must support.

3.45 In debris tunneling, constant watch must be kept for key timbers, beams, and girders, disturbance of which could cause movement of the pile and collapse of the tunnel. To avoid any accidental movement, horizontal pieces should be secured by a prop placed under them, still allowing passage of both men and stretchers. Recognizing these key pieces may be difficult. Thus bracing everything in the tunnel as the work proceeds will help prevent accidents. Time spent in careful bracing will not be wasted when compared with time necessary to reconstruct a collapsed tunnel.

3.46 When piles of debris are large, shafts may be found useful. It may be advantageous to sink a shaft to reach a basement level or a basement opening, and then tunnel horizontally to reach a victim. (See fig. 55.) It is important to remember that even though the materials in the area appear to be solid, the sides of the shaft must always be braced and timbered, and the timbers wedged securely into place.

#### TIMBERING AND LINING TUNNELS

3.47 The recommended method for constructing a debris tunnel is by the use of frames and forepoling. Frames are the primary supporting elements of the tunnel. They should be prefabricated outside the tunnel and assembled in position as the work progresses. Forepoling is the use of planks or boards driven between the collar and crownbar

DEBRIS CLEARED BACK AS FAR AS POSSIBLE BEFORE SHAFT IS STARTED

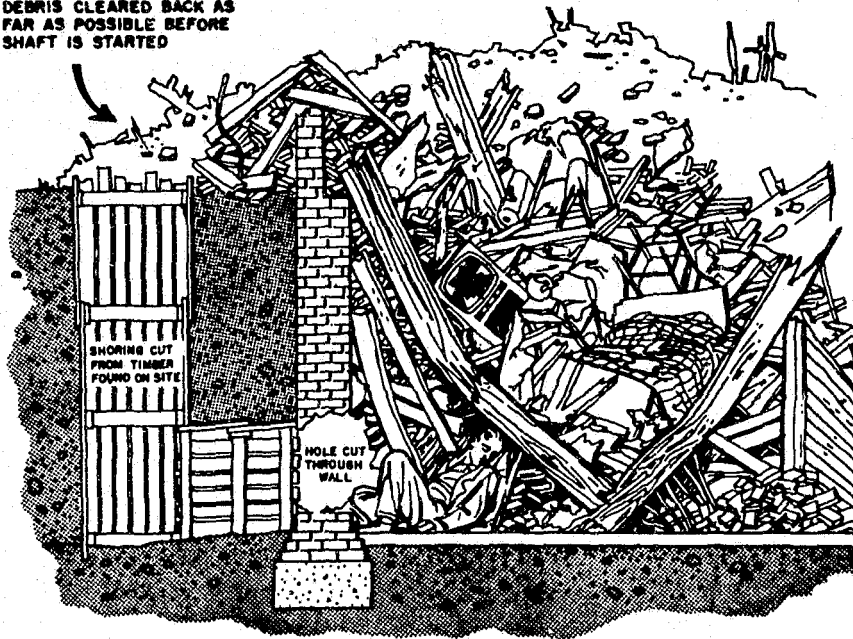

FIGURE 55.—Shafting and tunneling to reach void.

of one frame and extending beyond the next frame into the debris. Material for timbering and lining debris tunnels can usually be found in the wreckage.

3.48 Figure 56 shows a longitudinal section and a cross section of a frame tunnel using the forepole method. To start the tunnel three frames are constructed. The first frame does not require a collar or spacer blocks at the top, nor do any of the temporary frames. The second and third frames, and all other permanent frames in the tunnel, require 2-inch spacer blocks and a collar piece set on top of the crownbar. Frame No. 3 is set first against a cleared vertical face of debris and then frames Nos. 2 and 1 are placed next at approximately 3-foot intervals and solidly braced. Frame No. 1 should be diagonally braced to stakes driven solidly into the ground, about 2 to 3 feet in front of each strut. After the frames are in place the top is covered from frame No. 1 to frame No. 3 with long pieces of lumber, such as floor joists, roofing, or flooring. (Beyond frame No. 3 forepoles need to be long enough to overlap only from one frame to the next.)

3.49 The sides are lined in the same manner as the roof of the tunnel, driving boards between the frame struts and the rubble. To insure stability of the tunnel thus far completed, debris is piled against the sides and over the top. When completed, the frames should be completely covered

with exception of the first frame and diagonal braces.

3.50 When debris is removed about 2 feet beyond the third frame, the load on the forepoles may make it necessary to construct a temporary frame firmly wedged under them until enough debris is removed to permit construction of a permanent frame. The temporary frame should be removed after the permanent frame is properly braced and lined. This procedure is repeated until the tunnel is completed.

3.51 Usually, the debris of a demolished structure includes small rubble and dust, which will tend to trickle through the timbering. At first this may not seem important, but the escape of this material in quantity may disturb the mass of debris, causing internal movement. Therefore, a tunnel through small loose debris should be boarded as closely as possible.

3.52 Rectangular framing has certain disadvantages in debris tunneling. Since frames are not rigid, unbalanced side pressures may cause them to collapse. In some instances, short debris tunnels with small cross sections may be driven in the form of a closed triangle, using heavy planks keyed together at the ends. (See fig. 57.)

3.53 Regardless of the method used, the strutting or lining in a debris tunnel must be as rigid and tightly wedged as possible. Rigidity and wedging will keep the lining in position and

# DEBRIS TUNNELING CONSTRUCTION OF TUNNEL

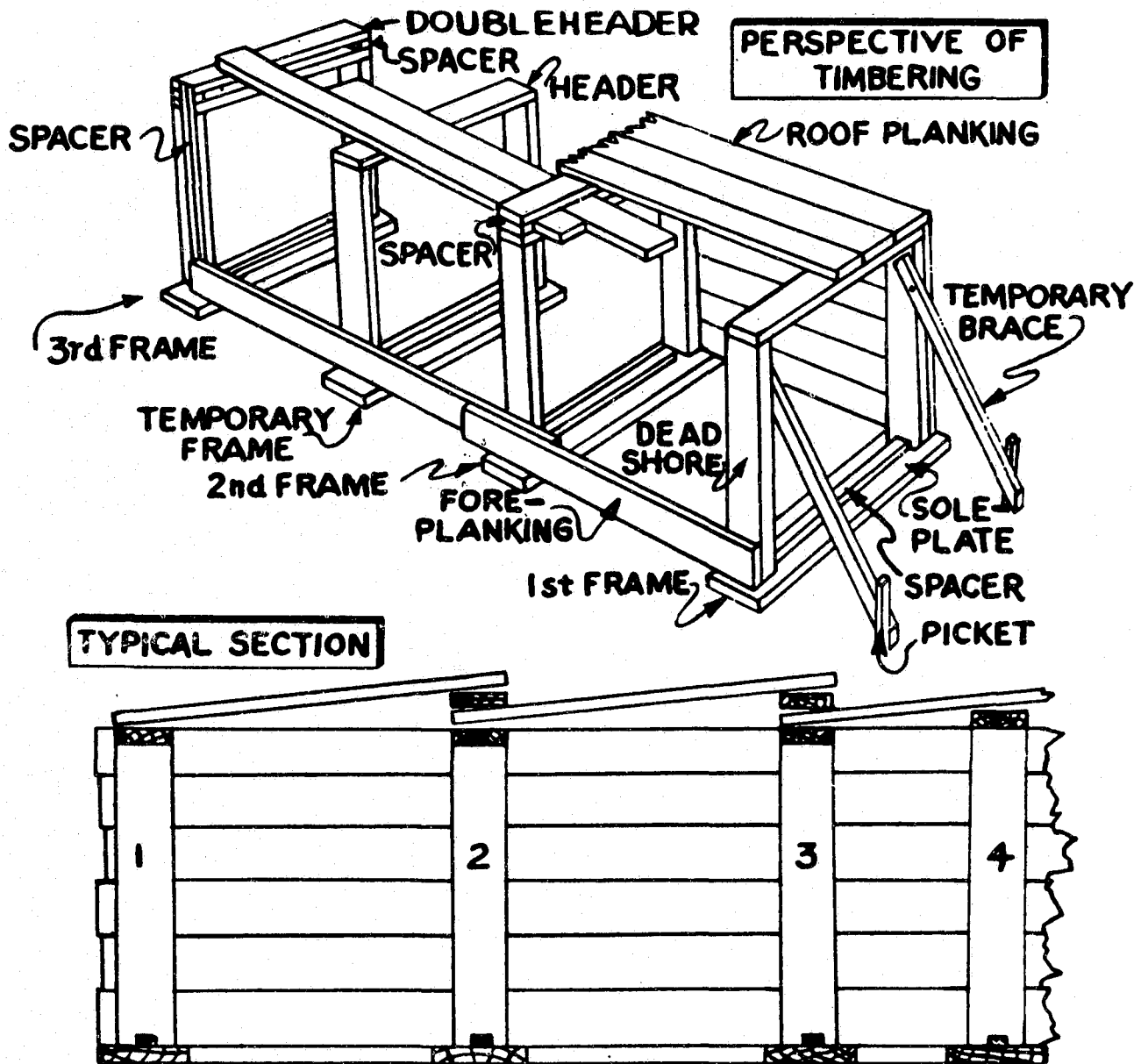

**NOTE** 1-2-3 PERMANENT FRAMES  
4 TEMPORARY FRAME

FIGURE 56.—Tunnel construction.



FIGURE 57.—Triangular tunnels.

prevent it from being broken by the impact of shifting or moving debris.

3.54 When there is doubt regarding the quickest means of access, two or more methods may be tried simultaneously. For example, a basement may be reached by one or more tunnels, or by a shaft from outside, all being attempted at the same time.

3.55 Rescue squads may have to remove persons from under collapsed basement walls or from basements still intact but with exits closed by debris. The squad leader may consider several different approaches. For example, he may break through the wall from an adjacent basement to reach lean-to spaces. Manholes or coal chutes may be cleared of debris to provide an entrance. Where ground floors have not collapsed, a small area may be cleared either by tunneling along the floor, or otherwise removing debris, and cutting a hole in the floor to gain entrance to the basement. (See fig. 58.) Where floors have fallen and the basement ceiling completely collapsed, a sloping tunnel may be driven from the edge of the debris downward to the floor of the basement. (See fig. 54.) A shaft may be sunk next to a building and into the ground along the basement wall, through which a hole into the basement may be made. (See fig. 55.) If the basement ceiling has collapsed, a solid mass of debris may be revealed when a hole

is cut through the outer wall. In this case, a trench or tunnel may be constructed along the outer face of the wall, and a hole driven into the wall at another point.

3.56 If a floor has collapsed, forming a void against one wall, and there appears to be a void against the opposite wall, a tunnel may be driven through the debris from the first void toward the opposite wall to reach the second void. However, it should be remembered that debris tunneling is one of the hardest jobs in rescue work and should be undertaken only when other means of gaining access are impractical.

3.57 Tunnel atmospheres known to be contaminated with toxic gases or deficient in oxygen will require that workers wear oxygen or self-contained breathing apparatus. Whenever a rescue worker is using a mask inside a tunnel, some means of communication should be provided to the outside. Although ordinary portable telephone equipment is unsafe for use in atmospheres containing explosive mixtures, self-energizing telephones are safe. A lifeline should be provided, not only as a means of locating a worker should the tunnel collapse, but also as a means of communication. Sash cord or cotton clothesline may be suitable. A person who collapses in a toxic atmosphere only a short distance into a tunnel can be pulled out by his lifeline. He



FIGURE 58.—Tunneling to gain entrance.

should not be pulled a long distance or around corners, since his facepiece may be dislodged, leaving him without mask protection. If a worker becomes unconscious, he should be carried out by fellow workers who have been standing by with proper equipment. Standard lifeline signals are given in paragraph 2.70.

### TRENCHING

3.58 Frequently an open trench can be completed more quickly than a tunnel if debris is not piled too high. Trenching and tunneling operations may sometimes be combined, with a trench extending into the debris until a tunnel becomes more practical.

3.59 To trench through debris, start by removing the larger pieces of timber, stones, or other objects from the face of the pile nearest the objective. Then clear a way into the debris by shoveling and other hand methods, removing the minimum amount of material necessary to provide a safe passageway. Progress is governed by the type of debris through which the trench is made.

3.60 Trenching may be dangerous. If a trench collapses the worker has little chance of avoiding injury. To avoid collapse or dangerous movement of the sides of a trench, bracing or some other method of retaining the sides may be required.

3.61 One satisfactory method is to drive sufficient sheet piling (usually lumber found at the site) into the ground. Additional support may be provided by horizontal bracing of the sheet piling, using screw or building jacks if available, or wood struts between the two retaining walls, as necessary.

3.62 Material removed from a trench should be piled at some distance away from the edge where it will not fall back into the trench or have to be moved again. The size of the trench will be governed by its purpose and the nature of the debris.

3.63 Trenching is used to reach a specific point, not for general clearance. A leader may decide to start two or more trenches to a given point simultaneously, since it is not always possible to determine the fastest route.

### BREACHING WALLS

3.64 Many different types of construction will be encountered in rescue operations. These include walls made of brick with lime mortar, brick with cement mortar, stone, concrete, and concrete block.

3.65 When cutting through walls or floors of large buildings, try to locate sections of the structures in which cutting can be done most quickly

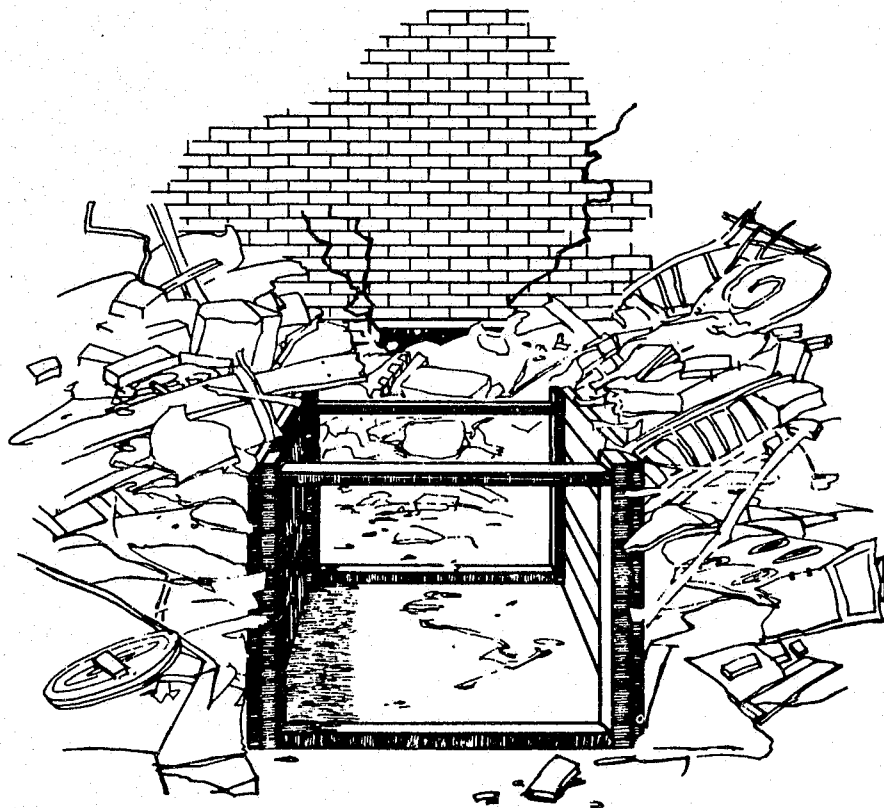

FIGURE 59.—Trenching.

and safely. When cutting through walls be sure that support beams and columns are not weakened. After a building has been subjected to bomb blast, the parts left standing may appear sound, although badly shaken and cracked. Therefore, when cutting away wall sections, especially with air hammers, care must be taken to prevent further collapse.

3.66 Openings large enough for rescue purposes usually can be made in brick walls without danger of the masonry falling. The bricks should be removed so that the opening is arch-shaped.

3.67 Concrete walls and floors, especially when they are reinforced, are difficult to cut through. Pavement breakers or other power tools will be helpful. Squad leaders should call for such equipment from the engineering services. In all walls and floors except concrete, the best method is to cut a small hole and then enlarge it. With concrete, however, it is better to cut around the edge of the section to be removed. If the concrete is reinforced, the reinforcing bars can then be cut by a hacksaw or torch, and the material removed

in one piece. If a torch is used, be sure explosive gases are not present, and that flammable materials are not ignited. A fire extinguisher should be kept nearby.

## VENTILATION

3.68 In constructing a tunnel, or gaining access to a basement, dust and the possibility of gases may make work difficult. Each person must have an adequate supply of fresh air. Thus ventilation must be considered. For dust or gases the filter-type gas mask should be used. Limitations of this mask must be understood, however, especially the fact that 16 percent of the atmosphere must be oxygen. In many cases, even when the mask is used, fresh air and ventilation must be provided. If compressors and air movers are used, care must be exercised not to recirculate the air removed from the tunnel. When using gasoline-driven compressors, be sure that exhaust fumes do not enter the compressor's intake. Use of an acetylene torch in a confined space may cause the air to become foul, and trapped persons and workers may

suffer if proper ventilation is not provided. An acetylene torch should never be used where there is danger from explosive gases.

3.69. Because of the danger of explosive gases, an open flame should never be used until all danger from this source has been eliminated. Further, an open flame will use up oxygen, and workers wearing breathing apparatus may have to operate in areas so deficient in oxygen that an open

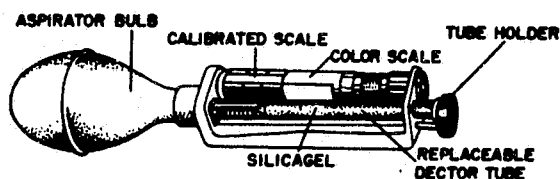

FIGURE 60.—Carbon monoxide indicator.

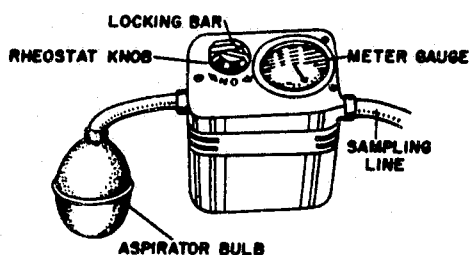

FIGURE 61.—Explosimeter.

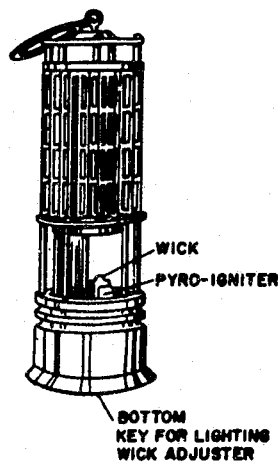

FIGURE 62.—Flame safety lamp.

flame or a carbide lamp will not burn. All lights taken into a confined space should be turned on before entering to avoid danger of explosion. All electric lights also should be of the permissible type to eliminate the possibility of explosion.

3.70 The sense of smell is not reliable as a warning against utility gas, particularly that containing carbon monoxide. A carbon monoxide indicator (see fig. 60) can be used to detect carbon monoxide.

However, this device does not indicate toxic gases and will not disclose an oxygen deficiency. Explosimeters (see fig. 61) may be used to detect explosive mixtures of gases. A flame safety lamp (see fig. 62) is a reliable device for determining oxygen deficiencies. These lamps can be dangerous in a flammable gas-air mixture unless they are properly used. No further attempt should be made to use such lamps after there is an indication of the presence of flammable gas. The lamps should not be used by untrained rescue workers.

3.71 Induced ventilation is the most effective means of dealing with gas hazards in confined spaces and may be the only way to save persons trapped under debris in the presence of escaping gas.

3.72 An air compressor is the simplest means of inducing ventilation. However, high-velocity air from an open nozzle or hose will stir up dust. Thus, the force of the air must be modified in some way. Placing the end of the hose into a tin can and tying this assembly in an empty bag will reduce the force of the air and eliminate much of the dust hazard.

## RAISING AND SUPPORTING STRUCTURAL ELEMENTS

3.73 Raising and supporting structural elements of collapsed and damaged buildings may be necessary before rescue workers can gain safe entrance to voids.

3.74 Usually when floors collapse they tend to hold together. Walls frequently fall over in large sections. By holding together and falling in large sections, floors and walls often create voids which, to some extent, protect people under them. Jacks, levers, and blocks and tackle will have to be used to lift such heavy sections. In this type of operation safety cannot be overemphasized. The squad leader must make sure that in raising beams, sections of floors and walls, or other large sections, the stability of the rest of the building is not disturbed, causing further collapse. He must be sure that any raised section is firmly supported by struts or cribbing before allowing anyone to crawl under it.

## SHORING

3.75 As defined in rescue operations, shoring is the erection of a series of timbers to stabilize a wall or prevent further collapse of a damaged



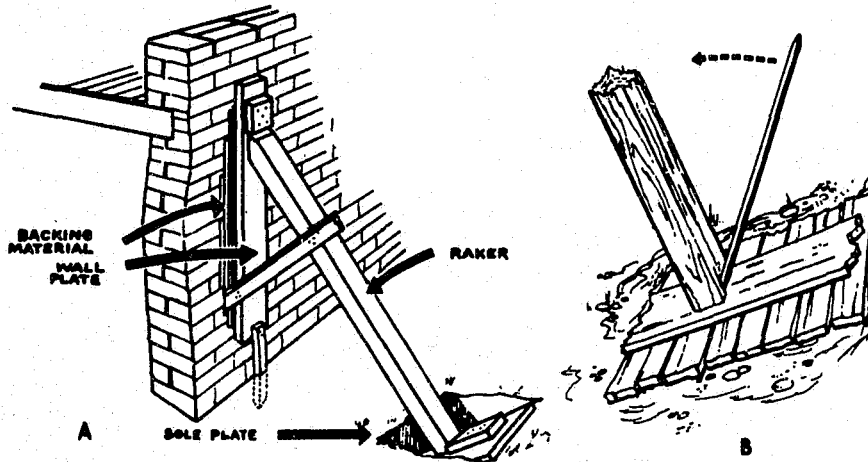

FIGURE 63.—Raking shore.

structure which endangers the conduct of rescue operations. Only temporary shoring will be done by rescue squads. Permanent shoring is the responsibility of the engineering services.

3.76 Shores should not be used to restore structural elements to their original position. Any attempt to force beams, sections of floors, or walls back into place may cause further collapse and damage. It is important, however, to secure all shores in position. This must be done gradually and without shock to the structure, using bars and wedges or jacks.

### RAKING SHORE

3.77 If a wall is bulging or out of plumb, shores may be used to brace the wall or hold it in position, especially if excavating or tunneling is being conducted next to it. These are called bracing, pushing, or raking shores. (See fig. 63.) The principal parts include wallplate, raker, and soleplate.

3.78 If possible, the wallplate should be continuous throughout its length. When used against a bulging wall, it should be backed with timbers to provide continuous bearing.

3.79 Rakers are best formed with square timbers. The number required varies from one to four, depending upon the height of the wall to be supported and the number of floors carried by the wall. Table 4 is a rough guide to the number of rakers and size of timber required for shores of different heights.

3.80 There should be one raker for each floor carried by the wall. The raker should be set so its foot forms a 60° to 70° angle with the ground.

Each raker should be arranged so its centerline meets at a common point with centerlines of the wall and floor, thus carrying the floor load directly on the shore.

TABLE 4.—Guide for use of rakers

Height of shore (feet)	Number of rakers	Cross-sectional area of raker built up to approximate square section (square inches)
20 to 30.....	1	25
30 to 40.....	2	36
40 to 50.....	3	50
Over 50.....	4	80

3.81 Nail a cleat to the wallplate where it meets the head of each raker. The wallplate must be secured to prevent it from sliding upward as the rakers are tightened into place. In a masonry wall the plate may be secured by extending cleats through an opening, or by nailing into the window frame. If there are no openings, secure the wallplate by driving nails or small metal pins into the mortar joints or into small holes in the masonry. A masonry wall in need of shoring is dangerous, and drilling or nailing into the wall must be done with caution.

3.82 Footings (platforms upon which lower ends of rakers rest) may have to be placed to distribute the weight of a very heavy load. The size of a footing will depend on the resisting power of the soil. They should be placed at right angles to the rakers, if possible.

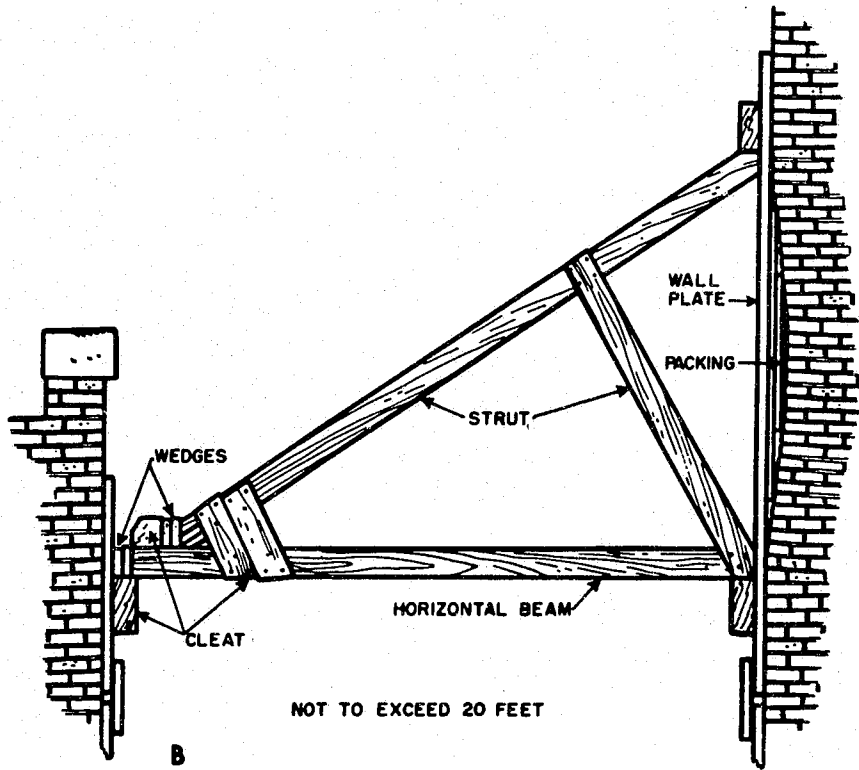
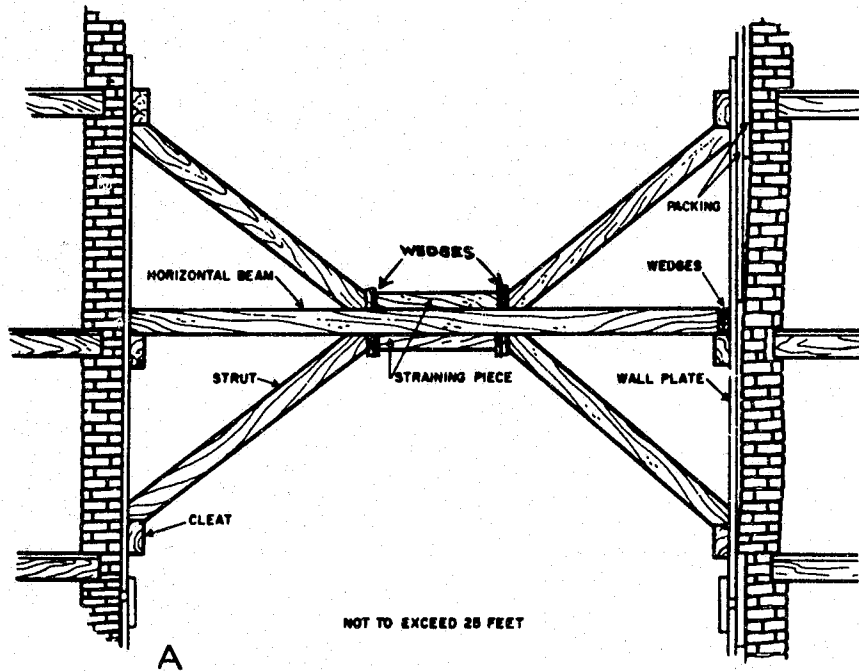

FIGURE 64.—Flying shores.

3.83 Soleplates should be placed to take the thrust of the raker at an angle exceeding a right angle, so it will become a right angle when the raker is tightened. Tightening should not be done with a hammer. Instead, a small notch should be cut in the foot of the raker, and a pry bar should be used in the notch to tighten the raker. (See fig. 63.)

3.84 Soft ground should be excavated and the bottom of the hole should be sloped toward the unsafe wall to provide the proper angle to the soleplate. On hard ground the soleplate should be built up to the required angle and spiked or wedged.

3.85 After placing the cleat on the wallplate and securing it to the wall, raise the top of the raker to the cleat and place the foot on the soleplate. Then gently force the whole structure into place. Nail a cleat to the soleplate at the foot of the raker to secure it.

3.86 Struts or braces may be fixed to prevent any movement of the foot of the wallplate, and to help prevent it from sliding up under the strain. Struts should be spiked to the raker and wallplate.

3.87 In supporting a wall, wallplates and rakers should usually be placed at intervals of from 8 to 12 feet, depending on circumstances, type of wall, and degree of damage.

### **FLYING SHORE**

3.88 A flying shore is used to brace a damaged wall when a sound adjacent wall can be used as a means of support. Two types are shown in figure 64. Principal parts are horizontal beams, wallplates, and struts. Other items are cleats, wedges, and straining pieces.

3.89 To erect, nail the cleats on the wallplate, one pair to support the horizontal beam or shore, and the others to support the struts. Set the struts at an angle not greater than  $45^\circ$  to the horizontal beam and keep them apart with straining pieces. The length of the straining pieces is determined by the length of the horizontal beam.

3.90 Proper measurements and angles can best be achieved by laying out the job on the ground prior to erection. While holding wallplates in position, place horizontal beam on the center cleats, and tighten with wedges and shims inserted between the shore and wallplates. Next, place struts and straining pieces into position. Cleats may be used to brace the shore more rigidly.

3.91 The wallplate should be continuous throughout its length, with packing between the wall and wallplate, if necessary, in order to provide continuous bearing.

3.92 Flying shores should be placed along a wall at intervals of 8 to 12 feet, depending on the situation, type of wall, and the degree of damage. They are not recommended for use between two walls separated by more than 25 feet.

3.93 Frequently a weakened foundation or damage to the lower portion of the wall makes it unstable. Causes of instability in a structure subjected to blast may vary. Since there is no standardized method of approach, meeting situations requiring shoring and supporting of walls and floors calls for careful planning and good workmanship. The lower part of the wall and its footing or foundation must carry the entire weight of the structure above it. If damaged by blast or by removal of an adjacent supporting structure, it may buckle or crumble. Therefore, bracing or shoring on lower parts of the wall should be stronger than corresponding work on the upper portions.

### **DEAD OR VERTICAL SHORE**

3.94 A dead or vertical shore is used to carry the vertical dead load of a wall or floor. (See fig. 65.) The principal parts are the strut, the soleplate, and the headpiece.

3.95 Struts preferably should be made of square timber, heavy enough to carry the maximum expected load.

3.96 It is difficult to estimate what load a strut must carry and to gage what load the strut timber can support. However, in strutting a damaged building, the following principles apply:

(a) For a given size of timber, the shorter the strut, the greater load it can carry.

(b) A strut of square cross section is stronger than a rectangular one of same cross-section area.

(c) A strut will be much stronger in service if its ends are cleanly cut so they fit squarely to the soleplate and headpiece.

(d) Struts should always be made a little heavier than appears necessary. The size used will be determined by the weight of the wall or floor to be supported, and by its height.

3.97 Folding wedges are set under the strut, the strut is driven into position with the wedges until it just takes the weight and no more.

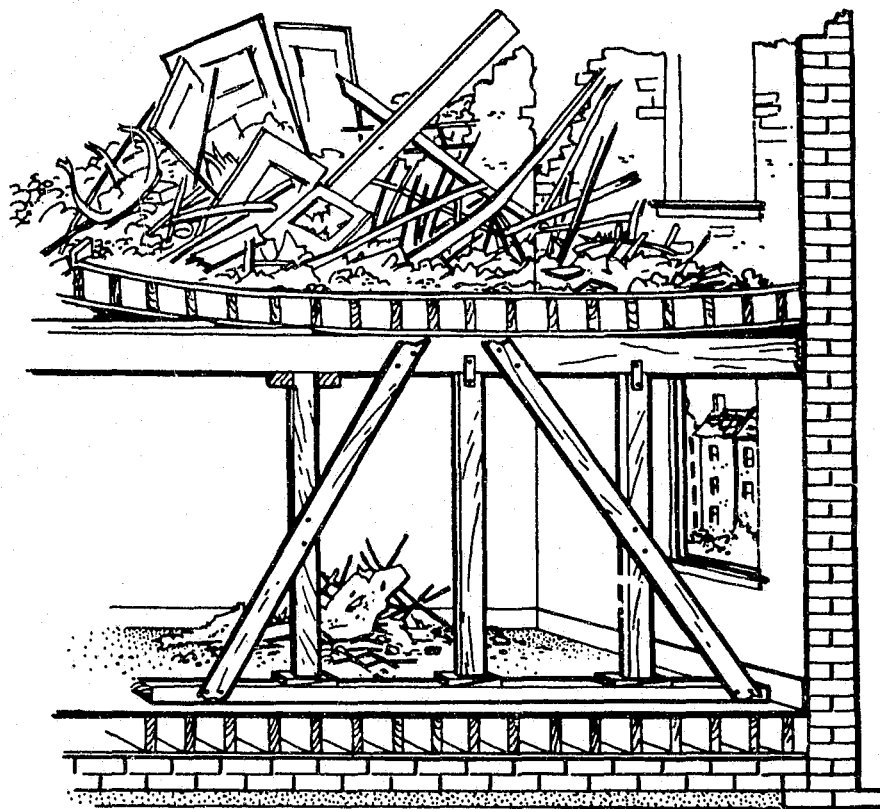

FIGURE 65.—Dead or vertical shore.

Wedges should not be driven tighter, since that would lift the wall or floor being supported and might cause more damage to the building.

3.98 The soleplate should be made as long and as wide as practicable to spread the load over a sizeable area. The soleplate should not be placed on a cellar arch or timber floor if there is doubt that the arch or floor can carry the load. In such cases, the soleplate must be supported from below. Where struts are used on the upper floors of buildings, the strutting should be repeated on all the floors so the load will have a solid foundation. An exception to this is when a strut can be supported on a heavy beam in a part of a building that has not suffered much damage.

3.99 The headpiece should have approximately the same cross section as the strut. However, the load being carried will be a determining factor here, also the span between struts where two struts are used. This span should be kept as small as possible, because the smaller the span, the greater the load the headpiece can carry.

#### STRUTTING

3.100 Strutting is employed to strengthen window and door frames when they are unsafe due

to cracked or damaged walls. Two methods of strengthening such openings are shown in figure 66. Many methods of strutting may be employed, but in any case, sufficient room must be left between the struts to enable a rescue to be effected.

#### REMOVING WALLS

3.101 When necessary to remove entire walls or parts of them to reach a specific location, the safety of trapped persons must be considered. The squad leader should make a careful study before a wall is removed to make sure the removal will not further weaken the structure and add to the danger. Shoring or bracing of walls of adjacent buildings may be necessary so part of a structure can be taken down in safety.

3.102 Working from the top down, walls may be removed, piece by piece, using picks, hammers, crowbars, and other tools and equipment. An entire wall or section may be toppled by a cable attached to a tractor or winch if this can be accomplished without endangering lives or causing other structures to collapse.

3.103 If the first method is used, the work should proceed systematically, story by story, and

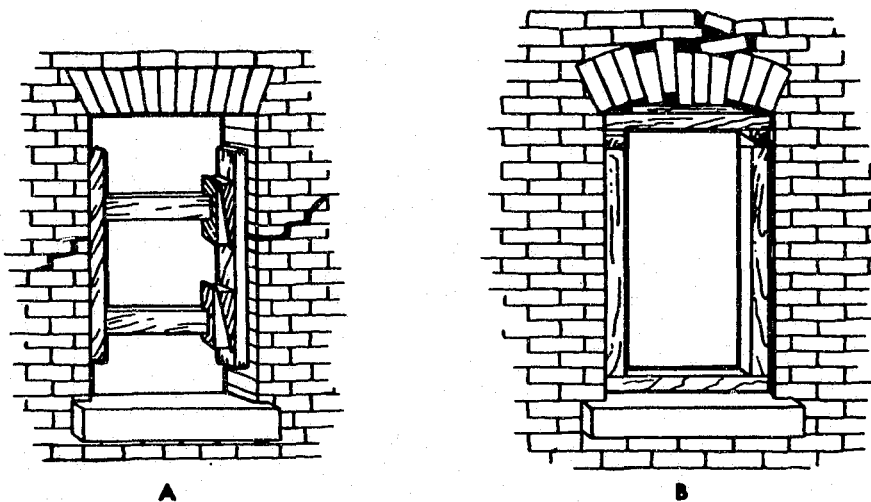

FIGURE 66.—Strutting window openings.

the work on the upper part of the wall should be completed before the lower section is disturbed.

3.104 If the wall is to be toppled, its direction of fall must be controlled. To control the fall, the line of weakness of the wall must be determined. If there is no obvious line of weakness, it may be necessary to create one by cutting away sufficient material at a suitable point so that as much of the wall as possible can be pulled down in the desired direction in one operation.

3.105 If a cable or rope is used to topple a wall, it must be securely fastened, so the force exerted will not pull out a hole but will topple the entire section of the wall with it. The longer the cable, the more nearly horizontal the pull and the greater its effect. The cable must be long enough to prevent the wall from falling on the men or machines doing the pulling.

3.106 Leaning a ladder against a wall may not be safe when attaching a cable to a severely damaged wall. An aerial truck ladder may be used or the boom of a crane may be used if one can be obtained. The cable may be placed in position by using a throw line to raise it to the top of the wall.

3.107 If winches are used, the drum should be allowed to run free as soon as the wall begins to topple to relieve the cable and drum from any shock.

### DEBRIS HANDLING

3.108 Shovels, picks, and other standard hand tools are used in debris removal only when the location of the casualty is definitely known and all

other casualties have been accounted for. Recognizing a body in debris is sometimes difficult. Therefore, tools, especially picks, if used at all, should be used with great care to avoid further injury to a casualty. Debris close to a casualty's known or expected location, should be removed only by hand.

3.109 Squadmen handling debris should wear gloves to prevent minor injuries. Debris should be removed in baskets, buckets, and wheelbarrows to areas clear of the damaged building. Only when it is reasonably certain that rubble or portions of buildings to be removed do not conceal other casualties, should cranes, power shovels, and bulldozers be used for debris clearance to gain access to casualty locations, or to prevent further damage or collapse which may hinder rescue operations. Such heavy equipment should be under the operational direction of the rescue leader. If necessary to pile debris in the street, avoid blocking traffic. All debris that has been moved should be marked.

3.110 Squad leaders, with the help of police must exercise constant vigilance to prevent disorganized and unsupervised groups from digging at random in the area. Workers should not climb over piles of debris unnecessarily—the disturbance may cause further collapse, making the rescue problem more difficult and decreasing a casualty's chance of survival.

3.111 As debris is removed, squadmen should provide necessary support or stabilize the debris to prevent dangerous movement and further collapse.

## CASUALTY HANDLING

4.1 The proper care of casualties during and immediately following release is as important as locating and freeing them from places of entrapment. Squadmen must be thoroughly trained in this aspect of rescue. Casualty handling includes emergency first aid, removal, and disposition of casualties. Since rescue operations will be conducted under a wide variety of adverse conditions, knowledge of these subjects must be combined with commonsense and good judgment. Squadmen should be thoroughly familiar with the local casualty services system.

### EMERGENCY FIRST AID

4.2 One of the primary functions of the rescue service is rendering first aid during the time that trapped persons are being released. There will be many instances when rescue squadmen, while extricating victims, can prevent aggravation of injuries and save lives by applying first aid. This includes controlling bleeding, giving artificial respiration, and proper treatment of fractures, burns, and shock. This section reviews these techniques as they apply to rescue operations. It does not replace regular instruction in first aid. Every rescue squadman should take either the American National Red Cross standard first aid course or the Bureau of Mines first aid course. Some team members should take additional first aid training.

### CONTROLLING BLEEDING

4.3 Most external bleeding can be controlled by applying pressure directly over the wound with a clean cloth (A, fig. 67). After the bleeding has been stopped, additional layers of cloth should be applied to form a thick covering—and then bandaged snugly or firmly.

4.4 For especially quick action, in some cases bleeding can be partially controlled by pressing the supplying vessel against the underlying bone with the fingers or heel of the hand. This is an

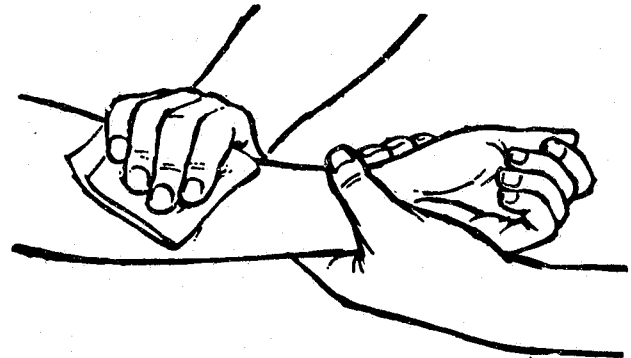
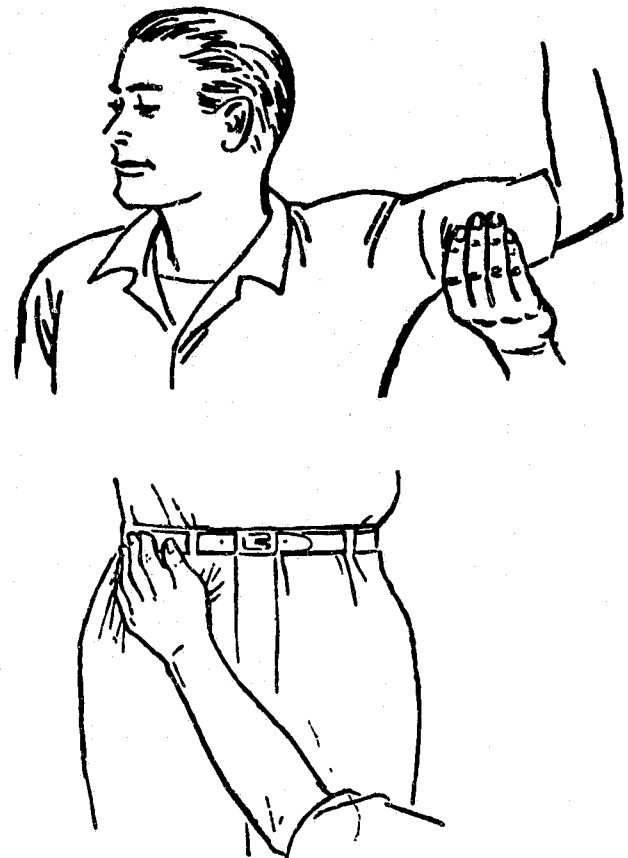

Illustration A.



Illustrations B and C.

FIGURES 67.—Controlling bleeding with pressure.

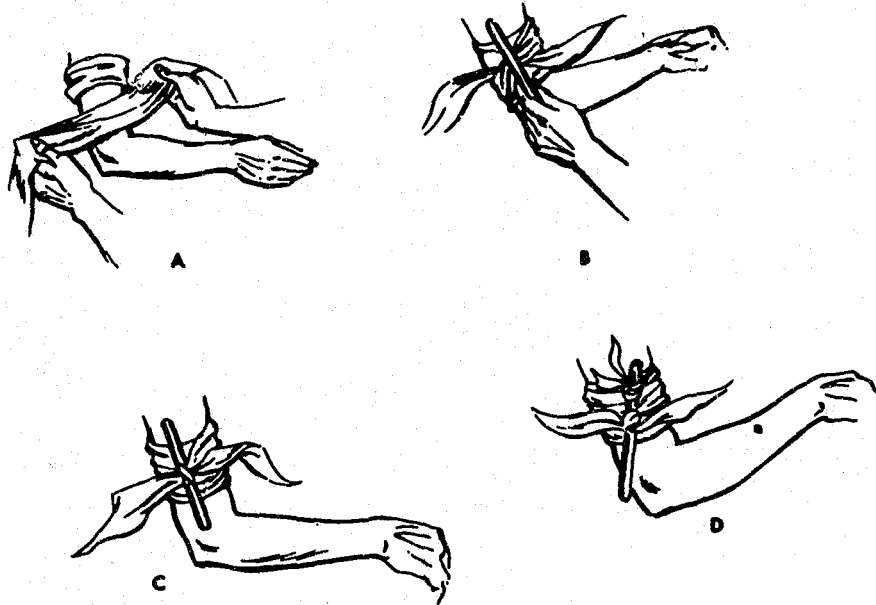

FIGURE 68.—Triangular bandage tourniquet applied to upper arm.

emergency measure to be applied until a clean cloth for direct pressure is obtained. The American National Red Cross recognizes only two points on each side of the body where pressure against the supplying vessel is of occasional practical use: (1) Pressure on the inner half of the arm, midway between the elbow and the armpit (B, fig. 67); (2) pressure applied just below the groin on the front, inner half of the thigh (C, fig. 67). If pressure is applied at these points, bleeding should diminish in the extremity below the point of pressure.

4.5 Tourniquets should be used only for severe, life-threatening hemorrhage that cannot be controlled by other means, or in cases of partial or complete severance of an arm or leg. The decision to use a tourniquet is in reality a decision to risk the sacrifice of a limb in order to save life.

When its use is justified, a tourniquet should be applied on the limb, as shown in figure 68, directly above the wound by a person trained in its use. Improperly applied, it may increase bleeding. Medical authorities have found that a properly applied tourniquet can be left in place for 1 or 2 hours without causing further damage to the extremity. It should not be released until a physician attends the casualty.

4.6 A triangular bandage folded to the shape of a narrow cravat will make an excellent tourniquet. A belt, handkerchief, or similar piece of material can also be used.

4.7 A tourniquet can be dangerous if put on too loosely or too tightly. It should be tight enough to stop the flow of blood. If too tight, there is danger of permanent damage to the artery. Pulse below the tourniquet should stop. Pulse for arm should be felt at wrist; for leg, behind ankle. A large letter "T" and the time a tourniquet is applied should be marked on casualty's emergency medical tag. (See par. 4.56.) Tourniquets, similar to that shown in figure 69, should be included in rescue first aid kits.

4.8 A tourniquet should be put on after the casualty's clothing has been removed, although it may be applied directly over clothing if too much blood would be lost from an artery while removing clothing. A bandage should never be applied over a tourniquet, because if bandaged over, the tourniquet would be hidden and might be overlooked at the first aid station. The "T" designation must be used and the time of application must be marked on the medical tag, whenever a tourniquet is used.

#### GIVING ARTIFICIAL RESPIRATION

4.9 Casualties removed from smoke or gas-filled areas and squadmen working on rescue jobs may be overcome and require artificial respiration. It should be given promptly. The back pressure-arm lift method, as taught in the American National Red Cross first aid course and described below, is one of the recommended methods. It

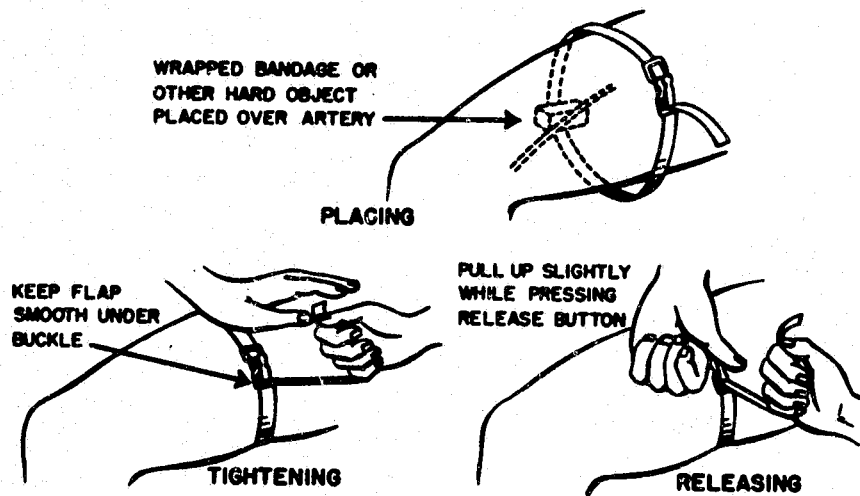

FIGURE 69.—Tourniquet applied to thigh.

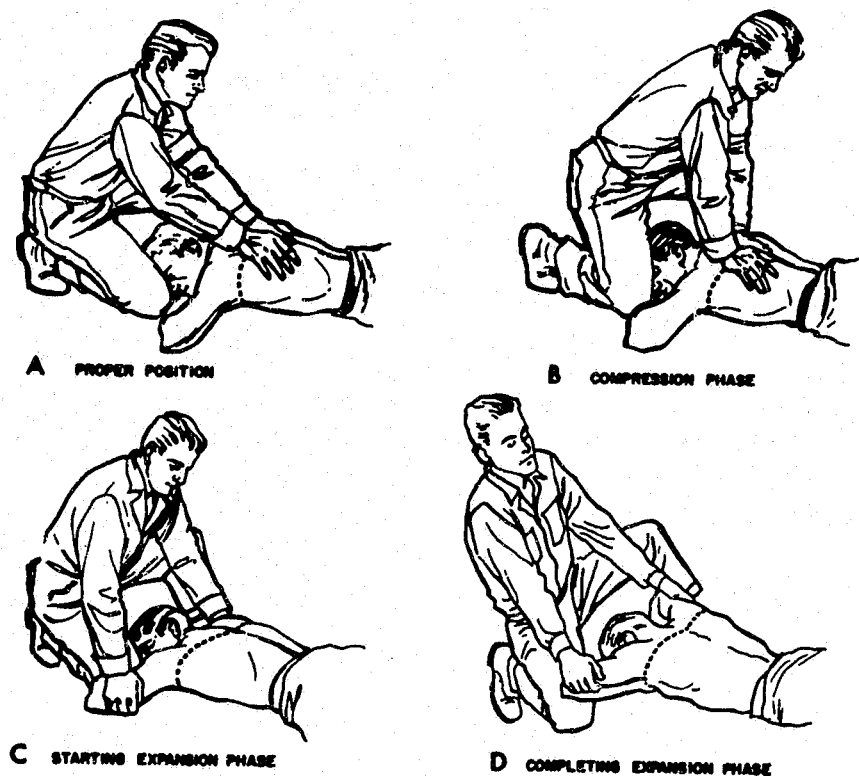

FIGURE 70.—Back pressure-arm lift method of artificial respiration.

should be practiced until each squadman is an expert. (See fig. 70.)

*Position of the subject*

1. Place the subject in the face down, prone position. Bend his elbows and place the hands one upon the other. Turn his face to one side, placing the cheek upon his hands.

*Position of the operator*

2. Kneel on either the right or left knee at the head of the subject facing him. Place the knee at the side of the subject's head close to the forearm. Place the opposite foot near the elbow. If it is more comfortable, kneel on both knees, one on either side of the subject's head. Place your hands upon the flat



of the subject's back in such a way that the heels of the hands lie just below a line running between the armpits. With the tips of the thumbs just touching, spread the fingers downward and outward (A, fig. 70).

#### *Compression phase*

3. Rock forward until the arms are approximately vertical and allow the weight of the upper part of your body to exert slow, steady, even pressure downward upon the hands. This forces air out of the lungs. Your elbows should be kept straight and the pressure exerted almost directly downward on the back (B, fig. 70).

#### *Expansion phase*

4. Release the pressure, avoiding a final thrust, and commence to rock slowly backward. Place your hands upon the subject's arm just above his elbows (C, fig. 70) and draw his arms upward and toward you. Apply just enough lift to feel resistance and tension at the subject's shoulders. Do not bend your elbows and as you rock backward the subject's arms will be drawn toward you (D, fig. 70). Then drop the arms to the ground. This completes the full cycle. The arm lift expands the chest by pulling on the chest muscles, arching the back, and relieving the weight on the chest. The cycle should be repeated 12 times per minute at a steady, uniform rate. The compression and expansion phases should occupy about equal time; the release periods should be of short duration.

#### *Additional related directions*

It is all-important that artificial respiration, when needed, be started quickly. There should be a slight inclination of the body in such a way that fluid drains better from the respiratory passage. The head of the subject should be extended, not flexed forward, and the chin should not sag lest obstruction of the respiratory passages occur. A check should be made to ascertain that the tongue or foreign objects are not obstructing the passages. These aspects can be cared for when placing the subject into position or shortly thereafter, between cycles. A smooth rhythm in performing artificial respiration is desirable, but split-second timing is not essential. Shock

should receive adequate attention, and the subject should remain in a prone position after resuscitation until seen by a physician or recovery seems assured.

### **MOUTH-TO-MOUTH TECHNIQUE OF ARTIFICIAL RESPIRATION**

4.10 The mouth-to-mouth technique may be used for administering artificial respiration to infants and small children, and for adults with chest or arm injuries. This technique, as taught in the American National Red Cross first aid course, is as follows:

1. Clear the mouth of any foreign matter with the middle finger of one hand. With the same finger press the tongue forward.
2. Now place the casualty in a face-down, head-down position and pat him firmly on the back with the free hand. This should help dislodge any foreign object in the air passage. (For infants and children, see A, fig. 71.)
3. Turn the casualty on his back and use the middle fingers of both hands to lift the lower jaw from beneath and behind so that it "juts out" (B, fig. 71).
4. Hold the jaw in the position described in Step 3, using one hand only (C, fig. 71).
5. Place your mouth over the casualty's mouth tightly enough to make a relatively leakproof seal, at the same time pinching the nose between forefinger and thumb to prevent escape of air. (See item 7 for infants and small children.) Breathe into the casualty's mouth with a smooth, steady action until you see the chest rise. During this action, alternate your hand from the jaw to the casualty's abdomen, between the navel and the ribs, and apply moderate pressure to prevent the stomach from becoming filled with air.
6. When the lungs have been inflated, remove your mouth from the casualty's mouth, free the nose, and allow his lungs to empty. Repeat this cycle as described in 5 and 6. For a child or infant, continue at the rate of about 20 cycles per minute; for an adult, about 12 cycles per minute. After every 20 cycles the operator should rest long enough to take one deep breath. If at any time you feel resistance to your breathing into the casualty and his chest does not rise, stop and

<sup>1</sup> Red Cross First Aid Textbook, American National Red Cross, Washington, D.C.

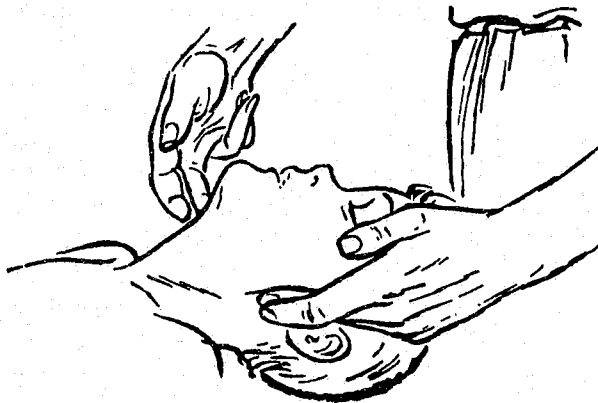
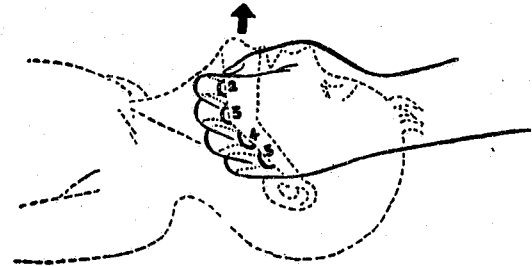
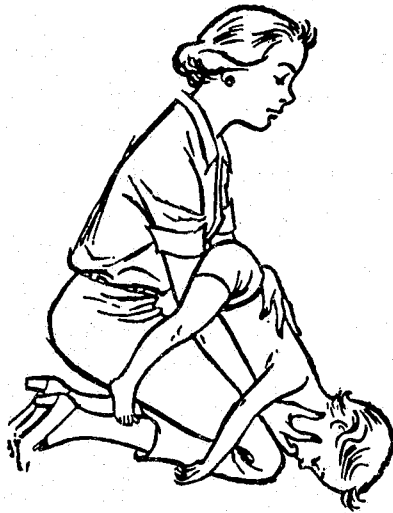

Illustrations A and B.

Illustrations C and D.

FIGURE 71.—Mouth-to-mouth technique of artificial respiration.

check his mouth for obstacles and pat his back firmly. Then quickly resume mouth-to-mouth breathing.

7. The following *modified* technique must be used on infants and small children:

Place your mouth over the child's mouth *and* nose, making a relatively leakproof seal. Breathe into the child with a smooth, steady action until the chest rises (D, fig. 71).

### SPLINTING OF FRACTURES

4.11 Many casualties will have fractures (breaks in bones) requiring care before removal from places of entrapment, so methods of immobilizing fractures are extremely important to rescue workers. When fractures occur there is

danger that the bone ends may be jagged and sharp. This may cause further injury by puncturing a blood vessel or severing a nerve. Splints should be applied to prevent movement of the fractured bone. The American Red Cross first aid textbook contains information on acceptable methods of first aid splinting for various types of fractures. It should be studied thoroughly.

4.12 Rescue squad equipment should include a set of board splints, a set of traction splints, and several fracture boxes. Drill should be conducted regularly until each squadman is proficient in their application.

4.13 A traction splint, which must be applied by two persons, is the best method of splinting fractures of the leg. The Thomas half-ring traction

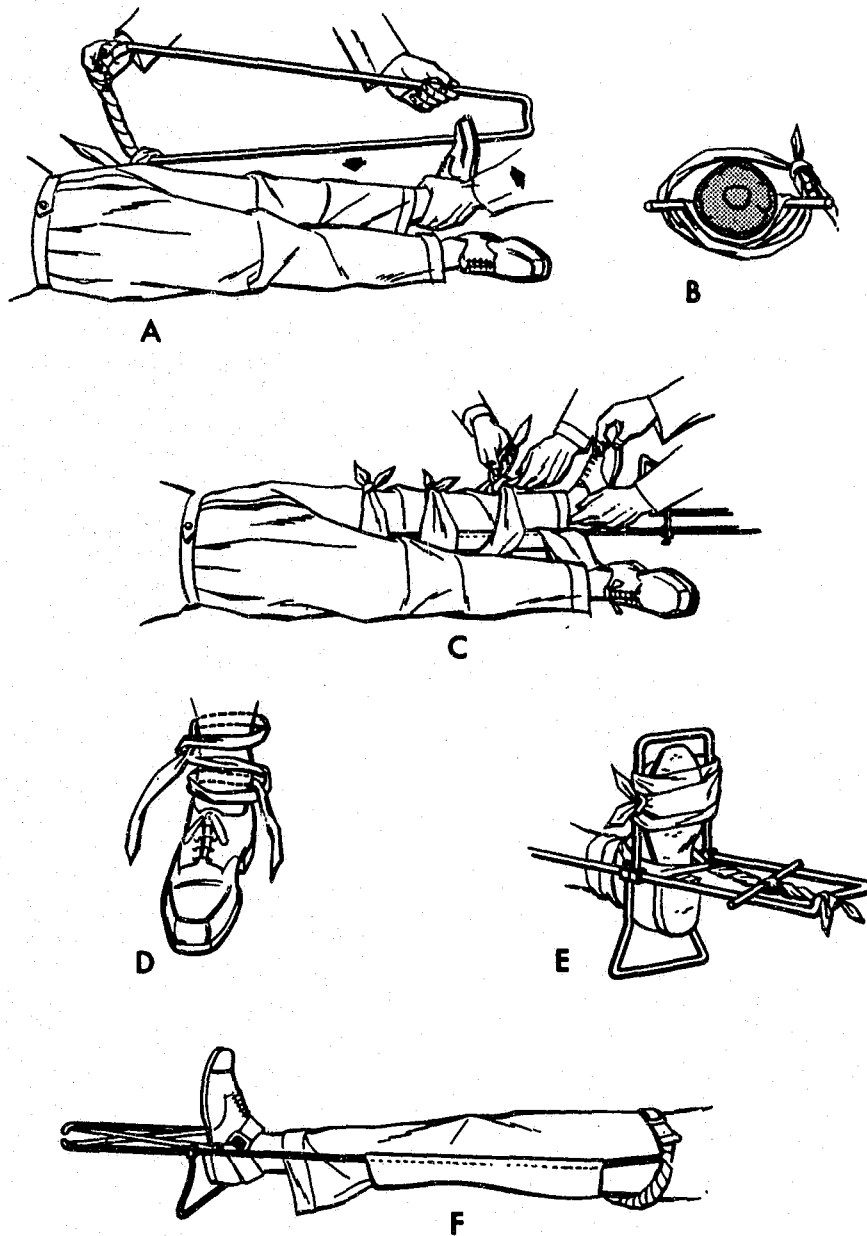

FIGURE 72.—Applying Thomas splint.

splint should be applied as shown in figure 72, using triangular bandages for the sling (B, C, fig. 72), for the tie at ankle (D, fig. 72), and for the traction band (E, fig. 72). A stand to raise the heel from stretchers is shown in E, fig. 72. Special sets may include web harness for ankle ties, and a sling which may be used instead of triangular bandages (F, fig. 72).

4.14 The fracture box is another quick method often used for splinting fractured legs, especially when casualties must be carried over rough ground. The fracture box consists of three boards, hinged together. It is easily applied by

placing a blanket on the open box for padding (A, fig. 73). The middle board is placed under the leg, the sides pulled up, and the web straps tightened (B, fig. 73). The leg is held securely and the casualty can be moved in safety. The leg can be further secured by tying it to the uninjured leg. A set of board splints should provide boards for every type of fracture.

4.15 While prepared splints should be part of squad equipment, improvised splints will be necessary on some occasions. Rigid materials well padded such as boards, broom handles, canes, wire mesh, umbrellas, and magazines may be used. Pil-

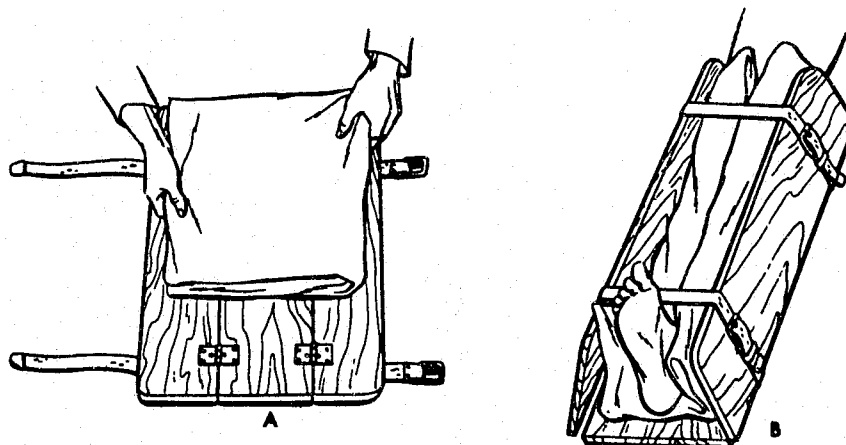

FIGURE 73.—Fracture box.

lows and blankets may often be used. (See fig. 74.) If none of these is available, a broken leg may be tied or bandaged to an unbroken leg for support.

4.16 *Fractured backs and necks.*—To immobilize casualties with fractured backs and necks and extricate them from trapped positions, which may include hoisting and lowering them, will require much practice. A Stokes stretcher will be very useful in performing this type of rescue. The backboard (see par. 4.45) is also useful for this purpose. Extreme care should be used in

transporting and raising or lowering a casualty with fractured spine or neck. If the neck appears fractured, transport casualty with face up; if it is the back, transport with back up and head turned to side. If in doubt, transport casualty face up. Do not flex casualty's back or neck in moving to backboard or stretcher. The casualty's head and trunk must be moved together as one unit. Injuries to the spinal cord may result in permanent paralysis or death. Pad each cross member of the backboard and tie the victim securely with triangular bandages or other strips

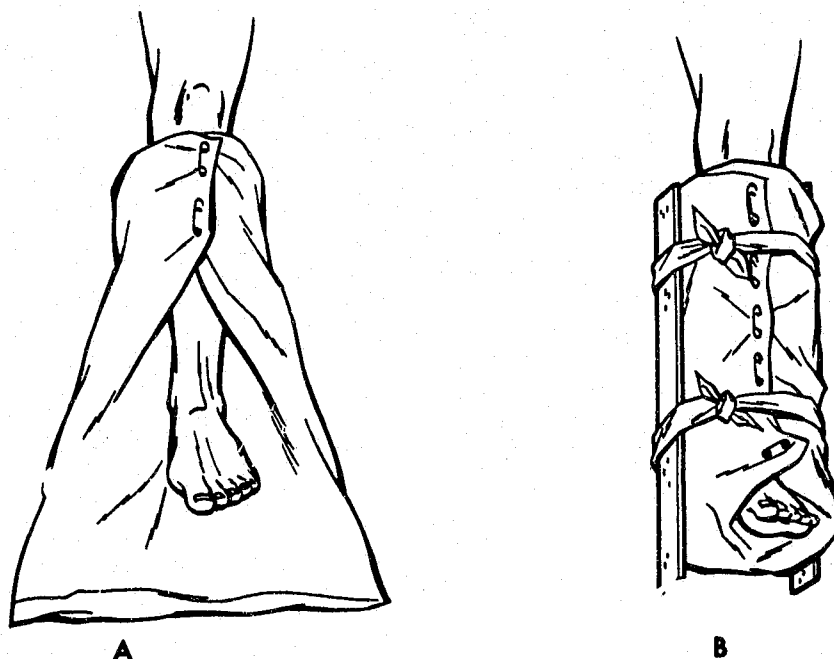

FIGURE 74.—Pillow splint.

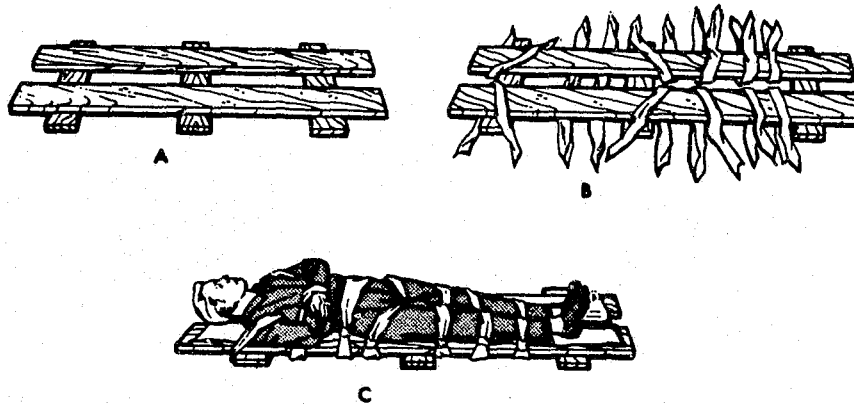

FIGURE 75.—Backboard used for casualty with fractured back.

of cloth (C, fig. 75). In raising or lowering a casualty horizontally on a backboard, use the 4-point suspension method, with one lashing at each end of the board and a loop over the crossboard at each end. The casualty should be unable to move or bend on the board.

### REDUCING SHOCK

4.17 Seriously injured casualties should be protected from shock during the various phases of rescue. Controlling bleeding with first aid measures prevents shock to some extent. There are other measures to prevent or reduce shock with which squadmen should be familiar.

(a) *Preserve body warmth.*—After casualty is released from entrapment and is awaiting further attention, he should be covered with a blanket or suitable covering to preserve body warmth. Another blanket should be placed under the casualty, especially in cold weather.

(b) *Talk to casualty.*—Seriously injured persons become frightened and excited about their condition, thereby increasing shock. Squadmen should talk to casualties and reassure them that everything possible is being done for them. This is especially true of trapped casualties awaiting removal.

(c) *Give water.*—Give water or saline solution if the casualty is in fairly good condition. It is not advisable to offer fluids to casualties losing consciousness, those with abdominal wounds, or those where immediate surgery is indicated.

### EMERGENCY TREATMENT OF BURNS

4.18 Burned areas should be covered before moving a casualty to protect them from further contamination as well as to help relieve the pain.

Cover the burned area with a clean, dry compress or plain gauze and bandage snugly in place. Burned persons are likely to develop shock and should be given plenty of water to drink.

### REMOVAL OF CASUALTIES

4.19 Rescue will be conducted under almost every conceivable form of adverse condition. The method employed for casualty removal will depend on the location of the casualty and the type of injury he has sustained. In some rescue operations casualties will have to be lowered from upper floors of buildings; in others they will have to be hoisted from below through holes in floors; or be removed by a combination of these techniques. After removal many will have to be carried over piles of debris and uneven ground before being turned over to casualty services personnel for transportation to first aid stations. Some will be seriously injured; some will be unconscious. Speed in removal is important but it should be consistent with safety and proper handling to prevent further injury. The method used will depend on the immediate situation, casualty's condition, type of injury, and available equipment. Squad leaders should conduct frequent drills in the removal of casualties, using live persons for drills, to give team members understanding and confidence in the various methods so they can make decisions promptly in time of emergency.

### CARRIES AND DRAGS

4.20 If there is immediate danger from poison gas, basement flooding, or building collapse, casualties may have to be removed before first aid



FIGURE 76.—Crutch assist.

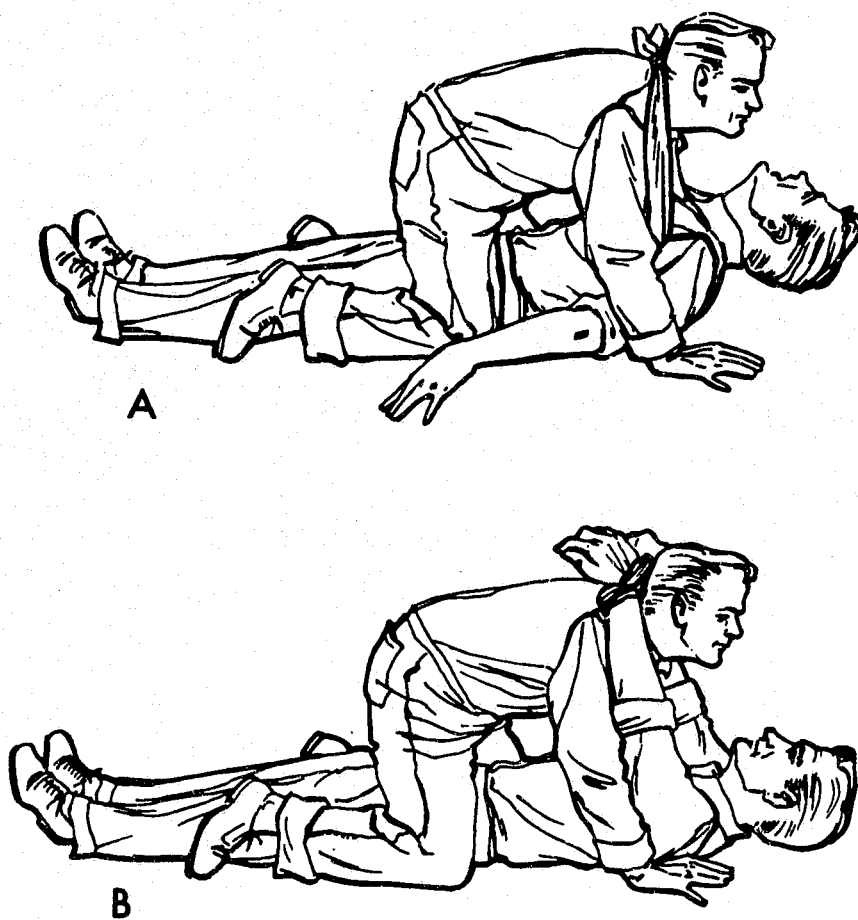

FIGURE 77.—Fireman's drag.

can be given or transportation provided. They should be moved only far enough to be out of immediate danger, then given emergency first aid and transported properly.

4.21 When casualties are only slightly injured or must be moved immediately in spite of injuries, one of several methods may be used. To the extent possible, the type of carry least likely to aggravate the casualty's injuries should be selected.

(a) *Crutch method.*—May be used to assist a slightly injured conscious casualty. Casualty places uninjured arm on squadman's shoulder, be-

material is not available for loop, casualty's wrists may be tied together, forming a loop of his arms (B, fig. 77). The fireman's drag is recommended in tunnels and other limited spaces, or in atmospheres where it is necessary to remain close to the ground to obtain an adequate supply of oxygen.

(c) *Pack strap.*—May be used to carry an unconscious casualty. Squadman makes loop of any convenient material, such as triangular bandages, sheets, belts, or rope; turns casualty on his stomach and passes loop around his chest at the armpits. He then places himself on his back flat on the casualty (A, fig. 78) and slips each arm

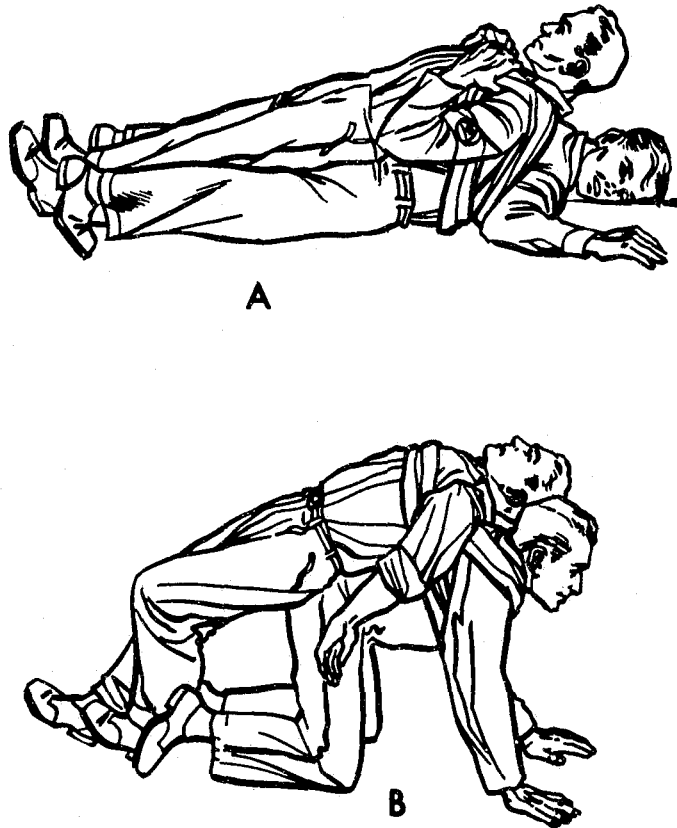

FIGURE 78.—Pack-strap carry (back to back).

hind his neck. Squadman grasps casualty's hand, passes his other arm around casualty's waist, and assists him to walk (A, fig. 76). Two men may be used, as shown (B, fig. 76).

(b) *Fireman's drag.*—May be used to move an unconscious casualty. Squadman turns casualty on his back and loops a cravat bandage, belt, rope, or other convenient substitute over casualty's head and under his arms. Kneeling astride casualty, he passes loop over his own head and drags casualty to safety (A, fig. 77). If sufficient

through the loop ends. The loop should fit snugly. He rolls himself and the casualty over onto his hands and knees (B, fig. 78), then gets to his feet with the casualty secured to his back. The casualty may also be carried as shown in A, fig. 79. In either case both hands of squadman will be free and he can go down a ladder if necessary. Dangling legs of casualty may prove awkward, but descent from a ladder will be possible. If sufficient length of bandage or similar material is not available, squadman ties casualty's hands to-



FIGURE 79.—Pack-strap carry (chest to back).

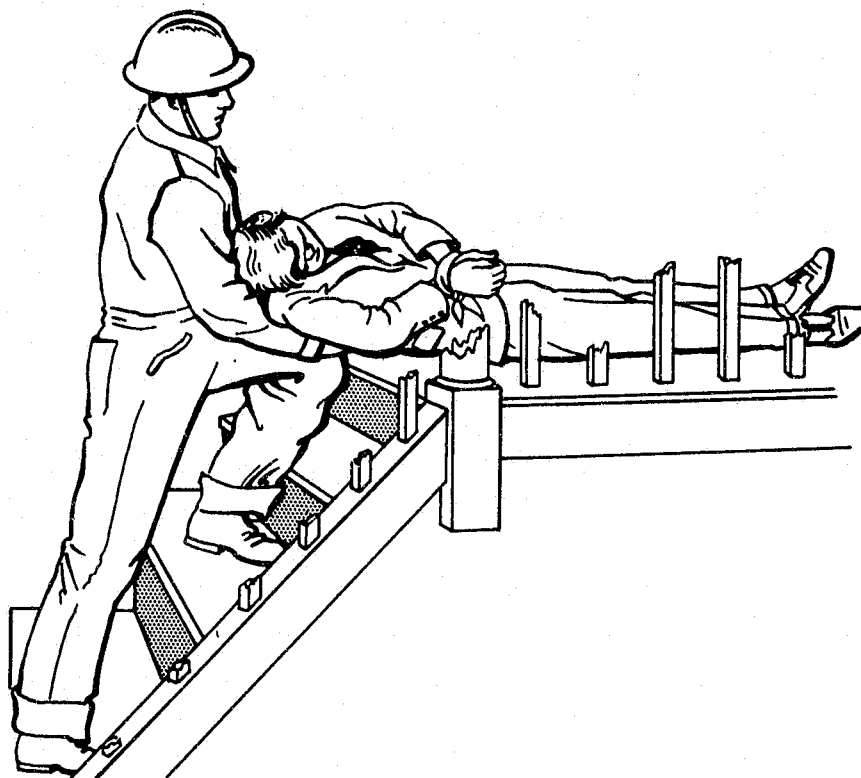

FIGURE 80.—Incline drag.



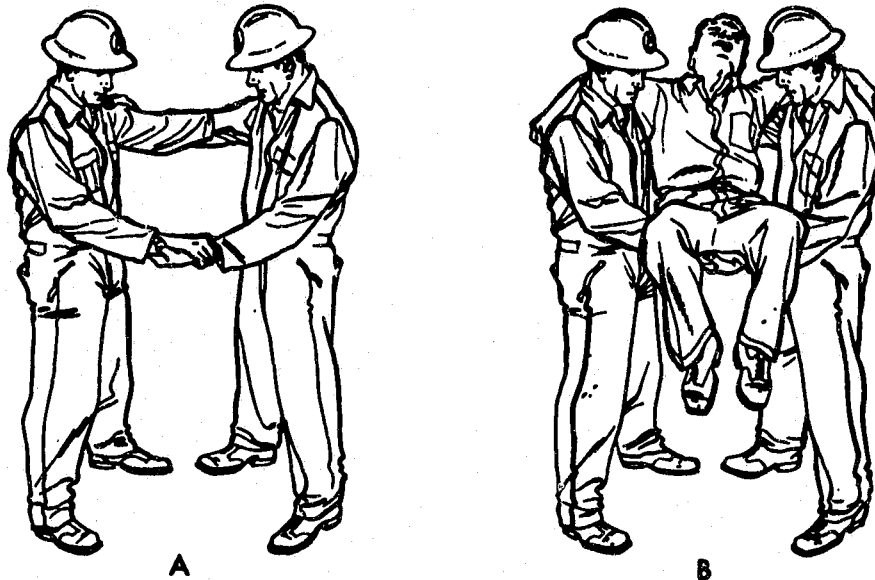

FIGURE 81.—Seat carry.

gether with rope and carries him as shown in B, fig. 79.

(d) *Incline drag*.—May be used to ease casualty down a stairway or incline. May be used when he is unconscious. Casualty should be placed on his back, head downward. The squadman crouches at casualty's head and grasps him under the armpits. Casualty's head is supported in the crook of squadman's arms. (See fig. 80.) If the casualty is unconscious, his wrists should be tied together.

(e) *Fireman's carry*.—May be used to carry injured or unconscious casualty. Squadman turns the casualty face down, stands at his head, grasps the casualty at the armpits, and lifts him to his knees. Squadman then clasps his hands just above the casualty's waist. With this grip he raises casualty to a semistanding position, slipping his left knee between the legs for support. Squadman then grasps casualty's left hand with his right and brings it around the back of his neck, holding the casualty's body close. He then passes his left hand between the casualty's legs and shifts him over his left shoulder to carry. To unload, squadman kneels, lowers casualty's head, and rolls him gently over on his back.

(f) *Seat carry*.—Requires two squadmen. They raise the casualty to a sitting position, each steadying him with an arm around his back. Each squadman then slips the other arm under casualty's thighs, clasping wrist of the other. One

pair of arms makes a seat rest, the other pair a back rest as shown in A, figure 81. Both squadmen then rise slowly in unison, lifting casualty from ground (B, fig. 81).

(g) *Fore and aft carry*.—Should not be used in case of leg or back injuries. Casualty is laid straight on his back, feet apart. One squadman takes position between casualty's legs, and the other at his head, both facing the feet. Squadman at head kneels, raises casualty's head, then grasps him from behind around the body and under the armpits. Other squadman passes his hands from the outside and grasps casualty under knees. Both rise together and move forward in step. (See fig. 82.)



FIGURE 82.—Fore and aft carry.

(h) *Chair litter carry.*—May be used when a chair is available to serve as litter. (See fig. 83.) Two men are required.

(i) *Three-man carry.*—May be used to carry severely injured casualty. Three squadmen line up on one side of the casualty, preferably with the tallest at the shoulders, one at hips, and one at knees. They kneel on knees nearest casualty's feet. Squadman at shoulders works his hands under casualty's neck and shoulders, the one at hips places his hands under pelvis and hips; and the one at knees, under knees and ankles (A, fig. 84). At the command "lift," usually given by squadman at shoulders, all three lift casualty, resting him on their knees (B, fig. 84). At a second command they slowly turn casualty toward them until he rests on the bends of their elbows.



FIGURE 83.—Chair litter carry.

At third command they rise together to a standing position (C, fig. 84). From this position, they may move with the casualty through narrow spaces and down winding stairs. Depositing the casualty requires a reversal of the procedure. These steps are recommended also for picking up the casualty and placing him on a stretcher. Stretcher should be placed under casualty when he is raised to knees of squadmen; on command he is lowered onto it.

### REMOVAL WITH EQUIPMENT

4.22 Rope is one of the most important items of equipment for casualty handling, both above and below ground. Instructions for tying knots and making a life basket are given in chapter 2. When speed is essential a safe substitute life

basket may be improvised by making a loop in a rope, and slipping it over the shoulders and under the arms of a casualty.

4.23 The Army-type stretcher will probably be used by most rescue squads. However, Stokes stretchers, and webbing bands will prove useful for moving casualties in tight quarters. (See par. 4.50.) When no stretcher is available it will be safer to improvise one than risk handling a casualty improperly.

4.24 The simplest improvised stretcher consists of two poles and a blanket, robe, rug, sheet, or tarpaulin (fig. 85). The blanket should be doubled over with one pole in the folded edge; both edges should then be folded back over the second pole. The weight of the casualty's body holds the free edge in place. An improvised stretcher can be made from two poles and two men's jackets, using the method indicated in figure 86. If no poles are available, a reasonably satisfactory stretcher can be made by placing the casualty in the center of a blanket or rug and rolling the ends toward him. (See fig. 87.) Two or three squadmen on each side will be needed to carry this type of improvised stretcher. A well-padded short ladder may be used as a stretcher, utilizing the ties explained later to secure the patient. A door, sheet of metal, or wide board also may be used.

4.25 A casualty may be injured in such a way that he cannot be lifted directly. A blanket-carry may be used in these instances. The Red Cross method of placing a blanket under a casualty is considered best. In this method the blanket is placed beside the casualty, with two-thirds of it tucked snugly against the body. Casualty is grasped at hips and shoulders and rolled gently, about one-eighth turn away from the blanket. The tucked part of blanket is pushed under him as far as possible. He is rolled back and over the tucked blanket. Then it can be pulled on through and used to lift him on or off a stretcher, or by rolling the edges toward casualty's body the blanket may be used as an emergency stretcher.

4.26 *Helping Person Down Ladder.*—Great care should be exercised in helping anyone down a ladder, even though the person being helped is conscious and uninjured. Squadmen should keep in mind that most people are unaccustomed to height. They may become frightened and either freeze or lose their hold. If the squadman is not in proper position he risks being knocked off the ladder should the person he is helping let go and fall.

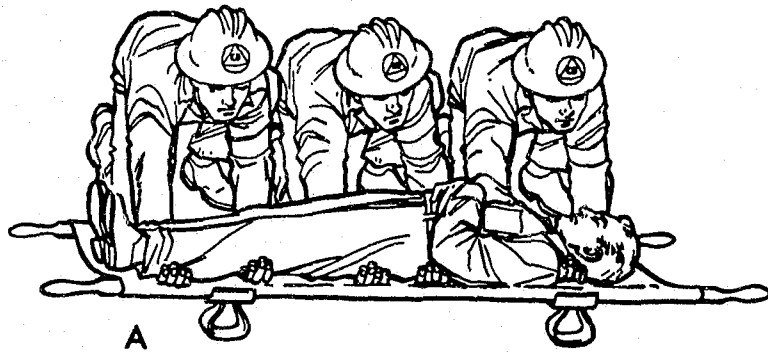

A

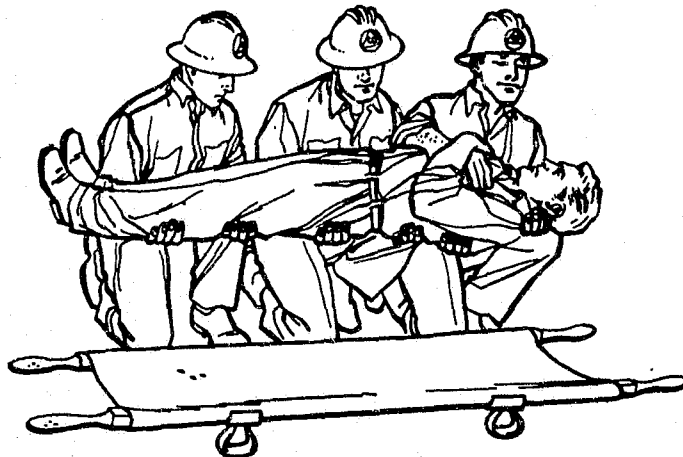

B



C

FIGURE 84.—Three-man carry.

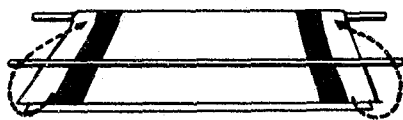

A



B

FIGURE 85.—Blanket and poles used to improvise stretcher.

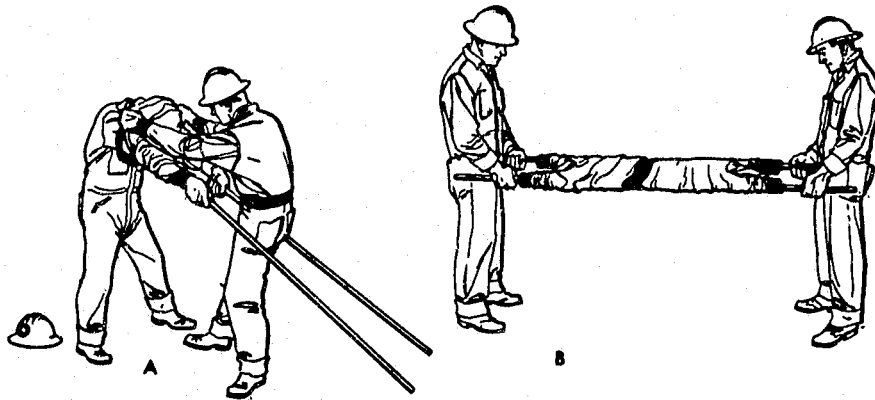

FIGURE 86—Jackets used to improvise stretcher.

Keeping close to the person being helped is essential. Best position is one rung below him with squadman's arms encircling the person's body and grasping rung. (See A, fig. 88.)

4.27 Squadman should keep in step with person he is helping down the ladder, letting him set the pace. He should precede person being helped, keeping his knees close together to insure support

in case the other loses hold or becomes unconscious. He also should talk to victim to help keep up his morale and overcome his fear. If victim releases his hold or becomes unconscious, he should be permitted to slip down until his crotch rests on squadman's knee. By repeating this procedure for each step down the ladder, squadman can lower victim to the ground. (See B, fig. 88.) The squadman

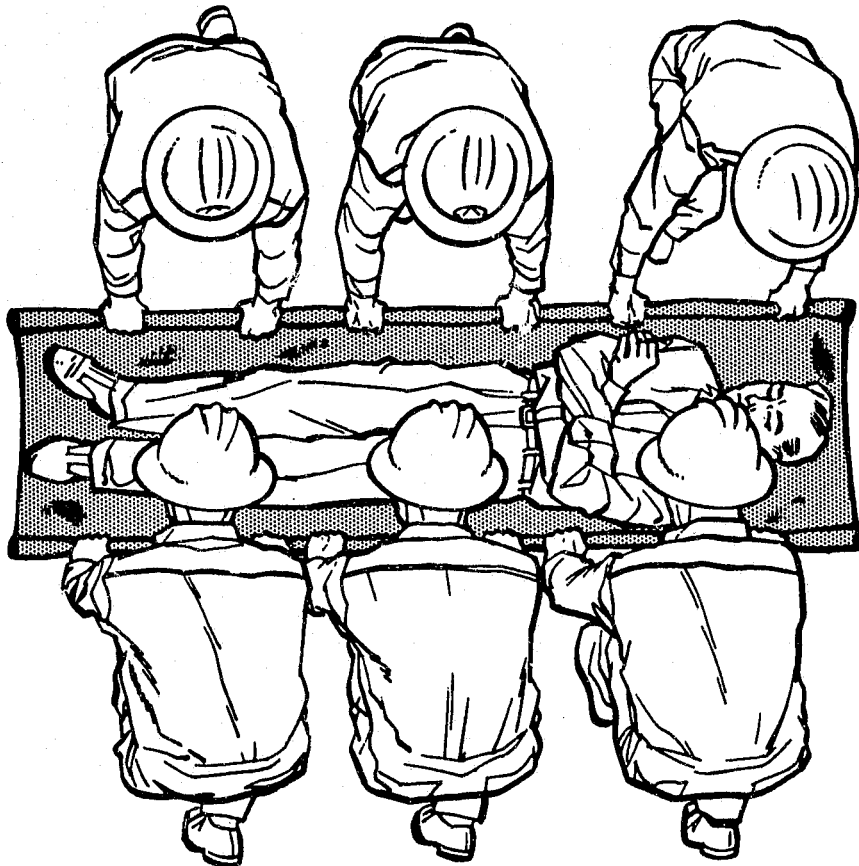

FIGURE 87.—Blanket or rug used to improvise stretcher.

should grasp the rails of the ladder rather than the rungs when the victim is unconscious.

4.28 Another method involves using a loop in the end of a rope or a loop slipped through the eye in the end of a rope. A squadman climbs ladder with the loop on his shoulder, leaving one end of the rope with a team member on the ground. When he reaches the point where he is to step off the ladder into the window or other opening, he removes the loop from his shoulder and passes it under the ladder and over a rung into the opening. (See fig. 89.) He takes the loop into the opening

be removed. The life basket should be tied and ready to receive the casualty before the squadman leaves the ground. He should pass the rope or basket under the bottom rung, and carry it as he mounts. This allows the rope to feed up the underside of the ladder. When he reaches the bottom of the window, the squadman should thread the rope back through the rungs, up and over at least two consecutive rungs, allowing the rope to hang freely next to the building. He takes the rope through the window and attaches it to the casualty or the stretcher. The casualty should

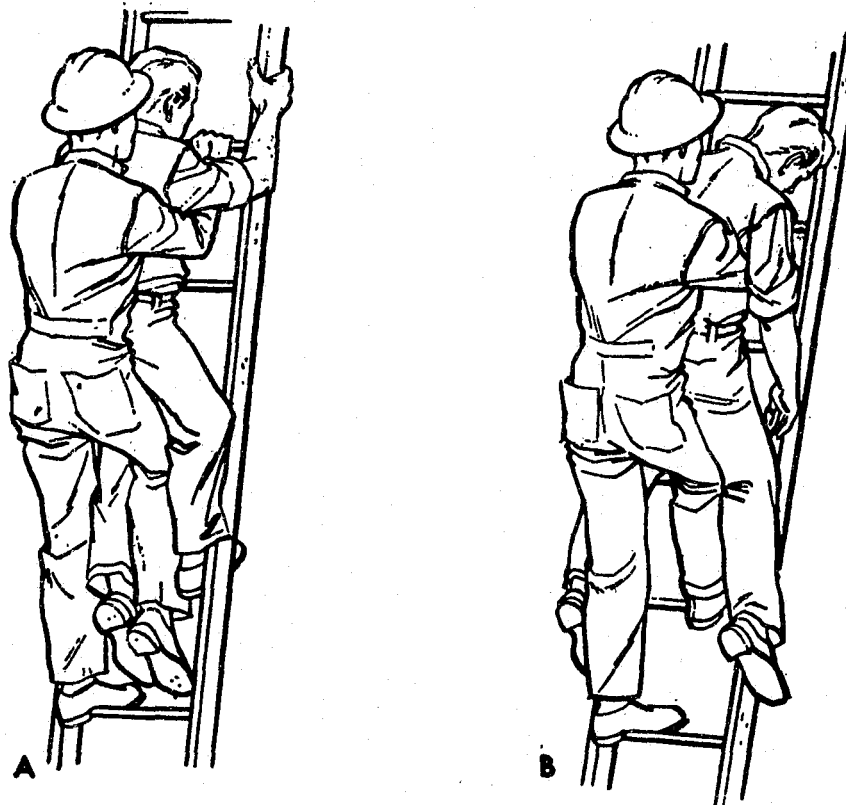

FIGURE 88.—Helping person down ladder.

and places it over the shoulders and under the arms of the person to be helped down the ladder. If the person being helped becomes unconscious or falls while he is on the ladder, the squadman on the ground will be able to take the weight off the squadman on the ladder and the operation can be completed in safety. In many cases the feel of the rope and the steadiness which it affords will tend to overcome fears of a person being helped.

4.29 A ladder may be used as a derrick to lower a casualty in a life basket or on a stretcher. The ladder should be raised to a point above the window, or opening through which the casualty is to

then be eased out of the window while a squadman on the ground takes up slack in the line. The casualty is lowered by the squadman on the ground, who should pay out the line slowly while steadying the ladder. (See fig. 90.)

4.30 *Blanketing a Stretcher.*—Casualties must be kept warm, so stretchers should be blanketed. Two blankets are needed: The first should be placed lengthwise across the head end of the stretcher, with the end flush with the tips of the handles (A, fig. 91); the second should be placed lengthwise with the stretcher, approximately 2 feet below the head edge of the first blanket (B,

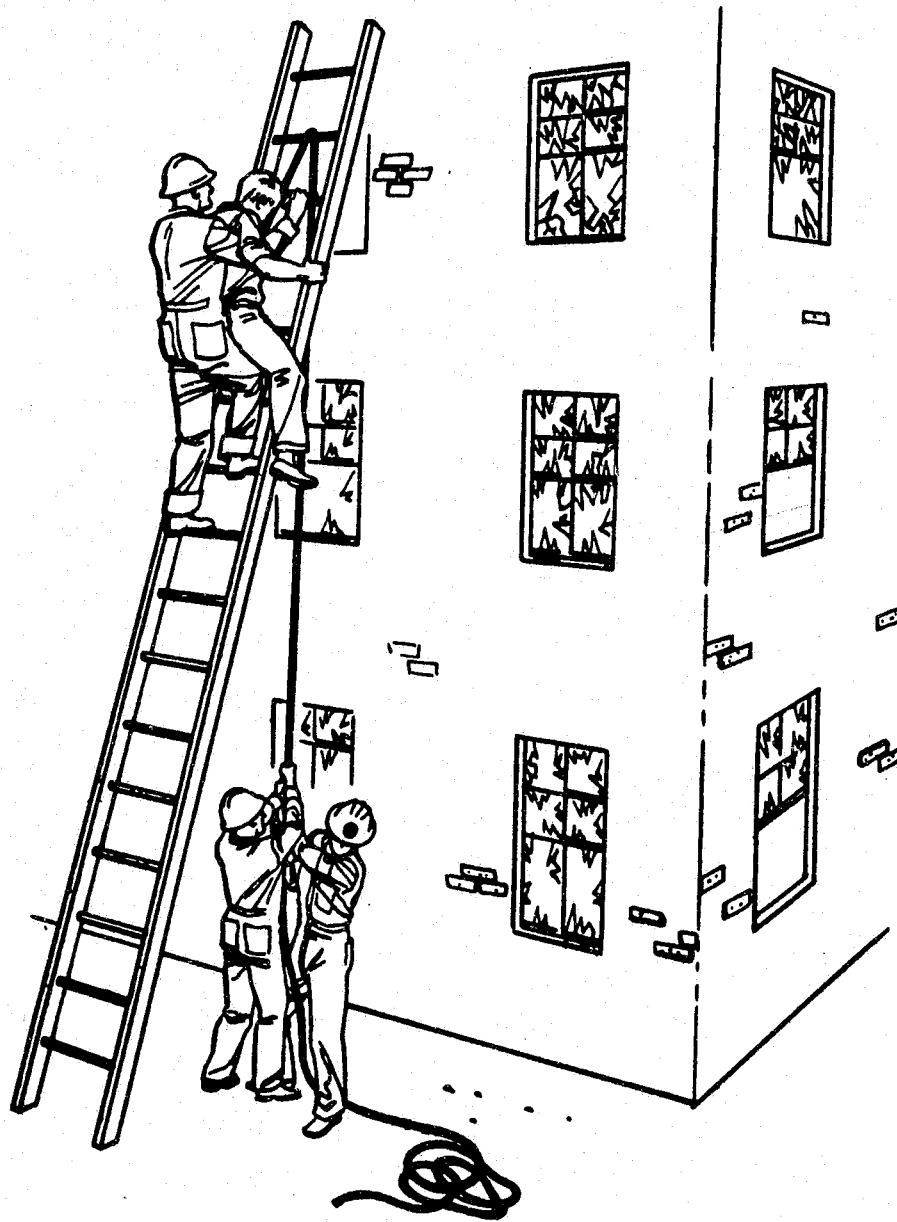

FIGURE 89.—Helping person down ladder with safety line.

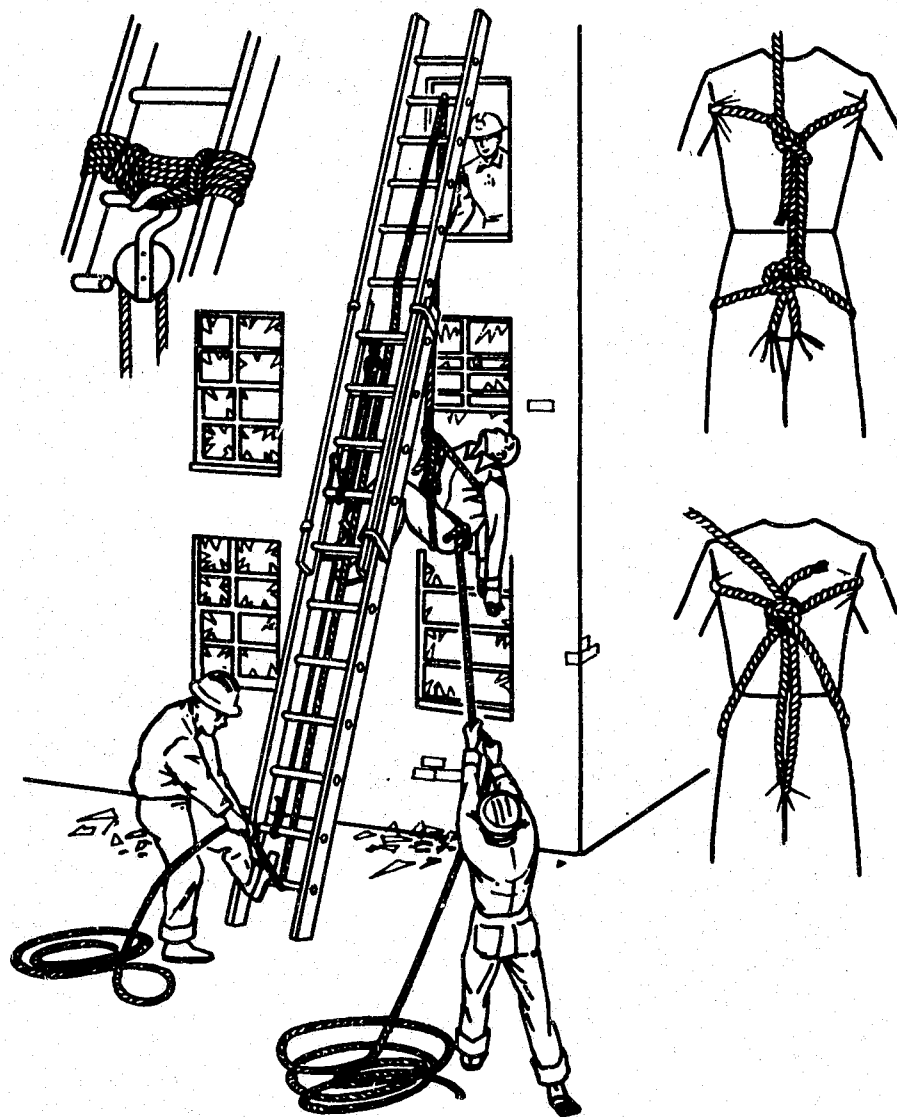

FIGURE 90.—Using ladder to lower casualty in life basket.

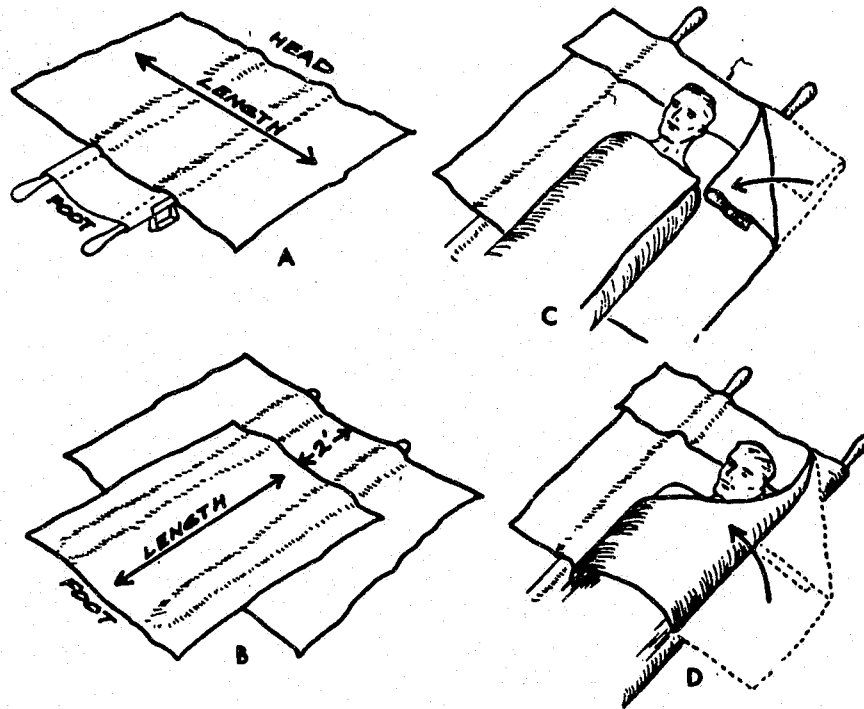

FIGURE 91.—Four steps in stretcher blanketing.

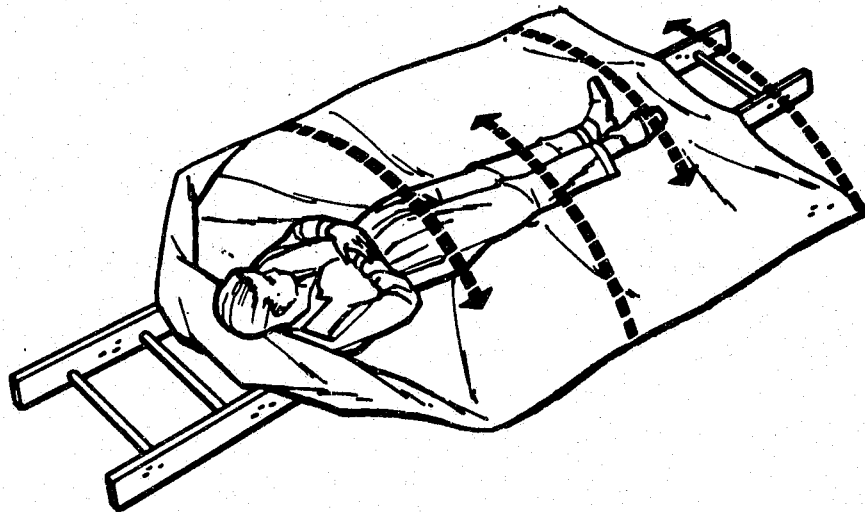

FIGURE 92.—Wrapping casualty in tarpaulin.

fig. 91). The exact position of the second blanket will depend on the length of the casualty. The casualty should then be placed on the stretcher, a cuff formed over his feet, and the sides of the second blanket folded over his body (C, fig. 91). The ends of the first blanket should then be folded over the body (D, fig. 91) and the excess tucked in.

4.31 When sufficient cloth blankets are not available, the use of one paper blanket and one

cloth blanket will suffice. The cloth blanket should be placed nearest to the casualty.

4.32 Where blankets are not available a tarpaulin may be used to wrap a casualty. The tarpaulin should be folded at one end with the corners making a point and rolled to make a head rest. The sides should then be folded over the casualty with the bottom surplus turned up to make a sack for his feet. (See fig. 92.)



## HOISTING AND LOWERING CASUALTIES

4.33 Some casualties may be helped down a ladder while others may have to be lowered in life baskets or stretchers. Although stretchers of various types and improvisations may be used, casualties on them should be kept in a horizontal position when possible. In many cases, however, it may be necessary to lower a casualty feet first through a narrow opening, such as a hole in the floor, or down an elevator shaft. In each case the method used will depend on the circumstances.

### HORIZONTAL METHODS

4.34 There are two methods by which a casualty on a stretcher may be raised or lowered while in a horizontal position: the one-point suspension method, and the four-point suspension

method. The first method is especially useful when lowering or hoisting casualties several floors, and when using lifting devices such as derricks, gin poles, A-frames, and others. Aerial fire truck ladders can sometimes be used for that purpose. The second method is more useful for shorter distances.

4.35 In preparing to lower a casualty horizontally first wrap him in a blanket, using the method described in paragraph 4.30 and lash him to the stretcher securely, using a 50-foot  $\frac{1}{2}$ -inch lashing line. Starting with a clove hitch on one of the handles nearest the head, pass the rope down one side of stretcher, taking a complete turn underneath and back over the casualty's chest, making a half hitch at the side. Use at least two more turns—one above the knees at approximately the hips, and one below. Then take a half hitch around the ankles and pass the rope around the

casualty's feet and bring it up on opposite side of stretcher, making a hitch around each rope crossing the casualty, and secure with a clove hitch on the handle. (See fig. 93.) The remaining rope may be coiled to form a rough pillow. The head of an unconscious casualty should be secured to the stretcher by means of a triangular bandage to prevent the head from rolling from side to side as the stretcher is moved.

4.36 To use the one-point suspension method after the casualty is securely lashed, with another rope measure three times the length of the stretcher, plus one arm's length. Double the rope and tie a bowline-on-a-bight (scaffold tie). Lay the rope on the middle of the stretcher and draw the two loops even. Then pass the large loops over each end of the stretcher and form smaller loops on each handle. Secured in this manner, stretcher may be raised or lowered without tilting. Guide-

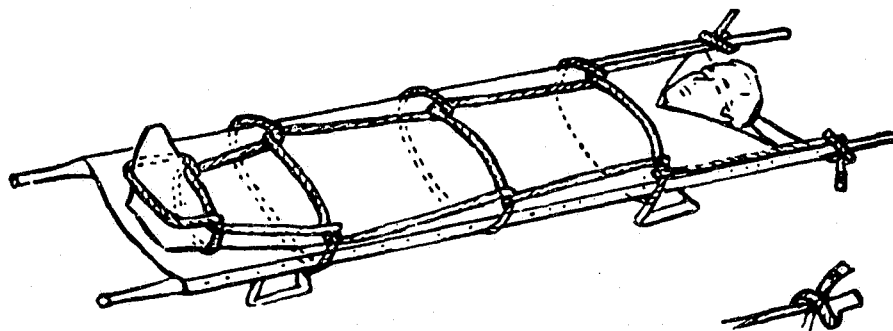

FIGURE 93.—Casualty lashed to stretcher for horizontal lowering or raising.

lines may be attached to stretcher D's when necessary.

4.37 To use the four-point suspension method, first lash the casualty as described in paragraph 4.35. Fasten a lashing line to each handle of the stretcher D's with a bowline, bringing each line up and around the stretcher handles by means of a half hitch. Four men are needed in hoisting or lowering, one man to control each line. (See fig. 94.) Where a stretcher is to be hoisted or lowered only a short distance, 50-foot lashing lines may be used.

### USING A LADDER AS A STRETCHER

4.38 If a ladder is substituted for a stretcher, either the one-point or four-point suspension method may be used. In either case, the casualty must be lashed securely to the ladder. The ladder should be padded with a board or other material.

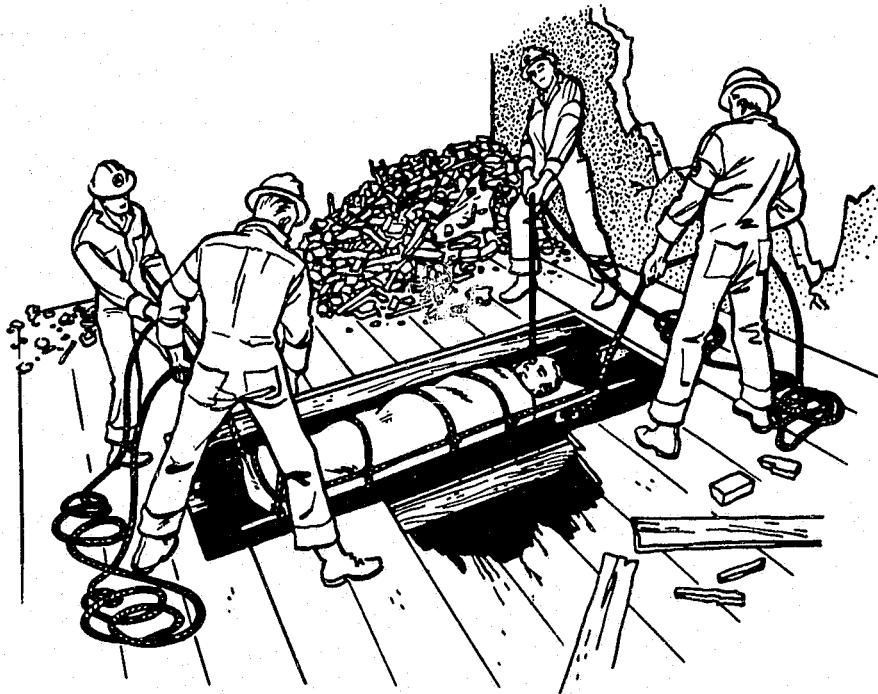

FIGURE 94.—Four-point suspension method.

4.39 To raise or lower a ladder in a horizontal position the one-point suspension method can be used. Measure off a rope three times the length of the ladder, plus one arm's length. Double the rope and tie a bowline-on-a-bight. This will make two large loops (scaffold tie). Lay the knot in the middle of ladder and draw the two loops even. To fasten this tie to the ladder, use the method shown in B, fig. 95. Pass a loop over each end of the

ladder. Bring bottom of each loop over the ladder's end rungs and loop it over ends of the rails. Ladder can then be hoisted or lowered without tilting (C, fig. 95).

4.40 To use the four-point suspension method, first lash the casualty as described in paragraph 4.35. Instead of using the scaffold tie, fasten a lashing line to each rail with a bowline between the first and second rungs on each end and make

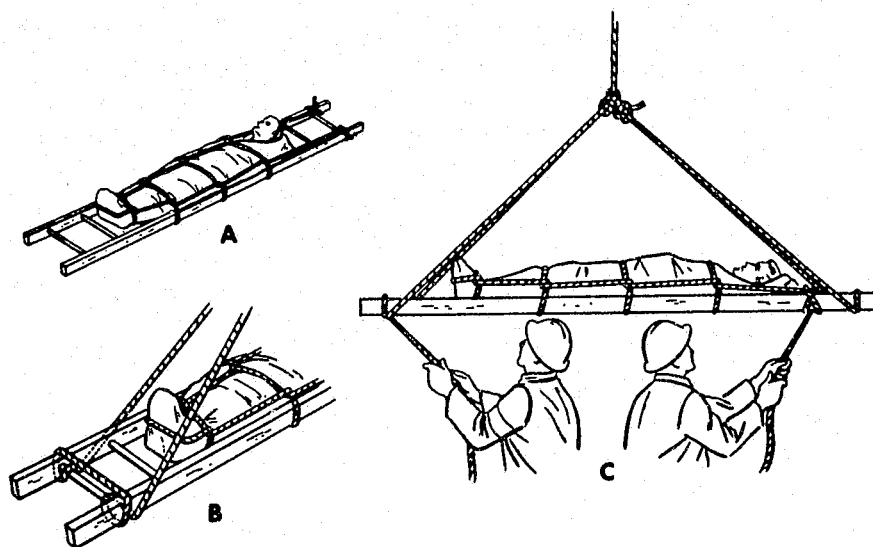

FIGURE 95.—Tie and lashing for hoisting casualty horizontally on ladder.

a half hitch on each rail near the end of the ladder. Four men are needed for hoisting or lowering—one man to control each line.

### VERTICAL METHODS

4.41 Frequently, because the only available opening is narrow, a casualty will have to be lowered feet first. Several methods may be used to lower a casualty in the vertical position. The

4.42 In using the Army-type stretcher to lower a casualty vertically, first lash the casualty securely as described in paragraph 4.35. Secure the lowering line by passing it through the D's at head of the stretcher and tying a bowline. Attach a guideline to the D's at foot of stretcher in the same manner.

4.43 If a ladder is used to lower a casualty feet first, the tie for supporting the ladder must be made first (A, fig. 96). The tie should be on

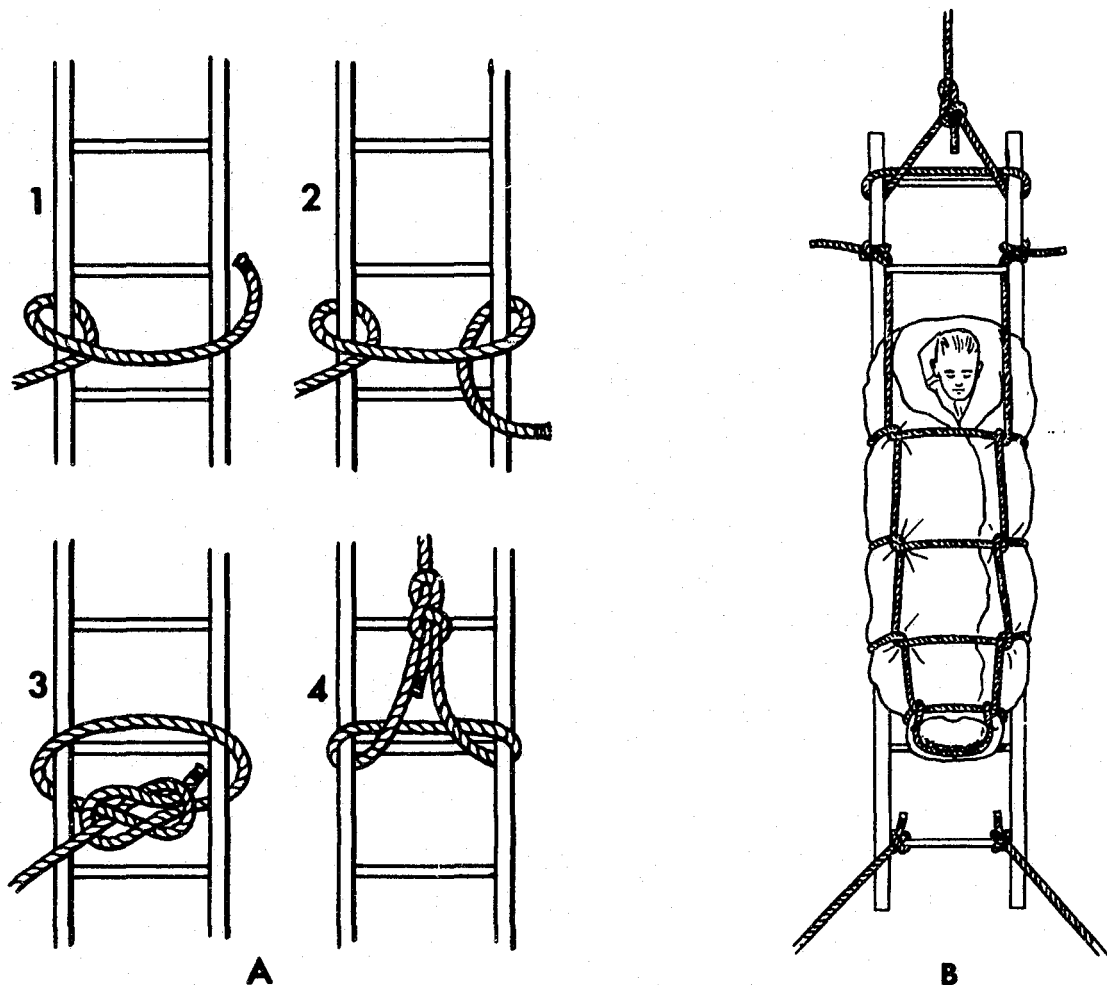

FIGURE 96.—Tie and lashing for hoisting casualty vertically on ladder.

Stokes stretcher is best for this type of rescue, since the casualty can be secured in it and a lowering rope fastened to the head end. The stretcher may be slid down a ladder or lowered directly by rope. If the ladder is used, one man on the ladder can help guide the stretcher down, while another at the foot can steady the ladder. When lowering this type of stretcher directly, attach a guide rope to the lower end of the stretcher and guide it down from the ground.

the top surface of the ladder when the casualty is lowered and on the under surface when the casualty is raised. Place the casualty on the ladder with his head on the third rung from the top. Lash the casualty as described in paragraph 4.35, placing the beginning and ending clove hitches around the rails immediately above the first rung beyond his head (B, fig. 96).

4.44 Because of inaccessibility, it may be necessary to transport, raise, or lower casualties

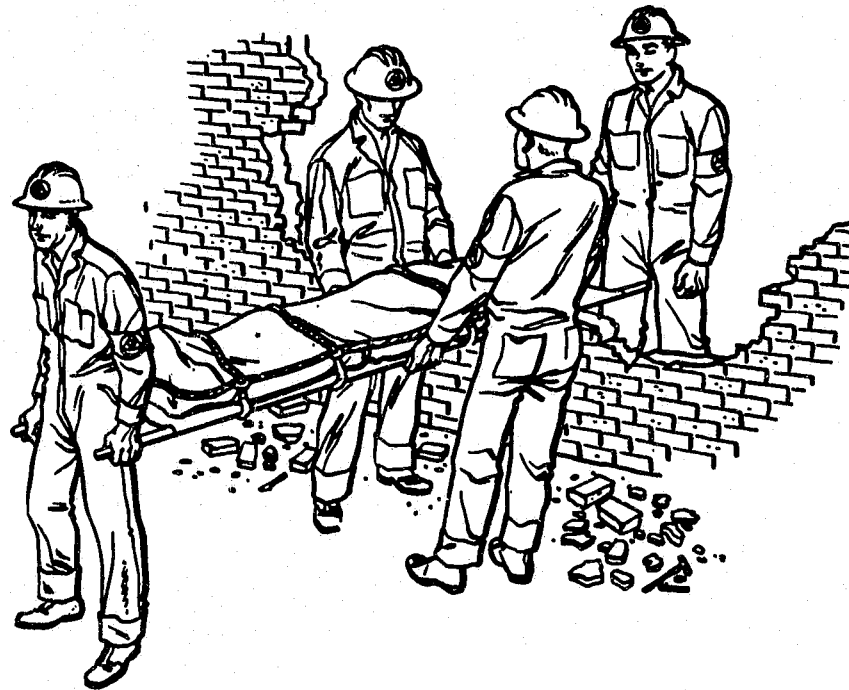
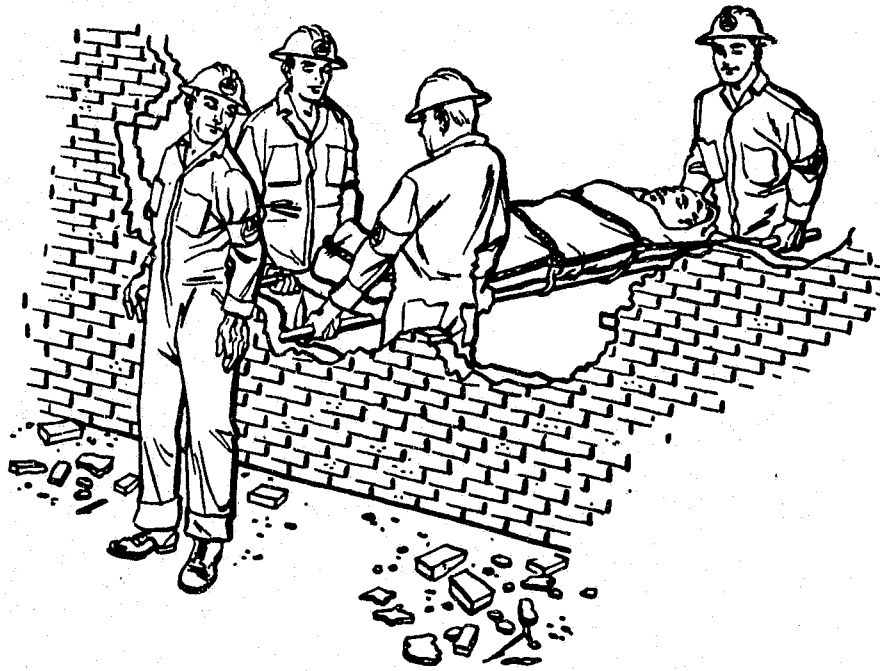

FIGURE 97.—Carrying stretcher casualty over obstacle.

without any type of stretchers. One method of lifting a casualty through a narrow floor opening, for example, is with a hoisting harness. Hooded body contour bags of the type used by fire and police rescue squads also prove useful in close quarters.

### **BACKBOARD AS STRETCHER**

4.45 A backboard is designed for transporting casualties with fractured backs or necks. It also can be used for hoisting and lowering a casualty horizontally and may be pressed into service as a stretcher for other casualties when regular stretchers are not available.

### **CARRYING STRETCHERS**

4.46 When possible, stretchers should be carried in a horizontal position. Usually, the casualty should be carried feet first, except uphill or upstairs when his head should be in front. However, if he has a fracture of the lower extremities, he should be carried uphill feet first and downhill head first, to prevent his weight from being pressed on the fractured part.

4.47 Stretcher bearers should walk in cadence, but not in step. When there are two, one should be at the head and one at the foot. When there are four, the additional two should give extra support on either side of the stretcher. When going over piles of debris and other obstacles, side bearers should take the front weight while the front bearer crosses the obstacle, and the rear weight while the rear bearer crosses. (See fig. 97.)

4.48 Several methods may be used to bridge gaps or spaces between buildings with ladders. Three men may bridge a gap, as shown in A, figure 98. The two men in front act as a fulcrum, while the third pushes the ladder forward. B, figure 98 is a variation of the same method. C, figure 98 shows another method in which a second ladder may be used as the fulcrum. The second or third rung of the ladder to be used as a bridge is placed on the heel plates of the vertical ladder. If there are no heel plates, the bridging ladder may be lashed to the vertical ladder by a lashing line or rope tie. By this method two men can push a ladder across a limited open space with little difficulty. On any ladder used as a bridge, a board should be placed on the rungs to strengthen it and permit easier walking.

### **OTHER METHODS**

4.49 In cases where it is impossible to get a stretcher through a tunnel, place the casualty on a blanket or small board and drag him out. The fireman's drag may also be used.

4.50 Webbing bands in sets of four may be used in lifting and transporting casualties. A, figure 99 shows the two sizes of bands, placed in position to lift the casualty. The shorter bands are used at the head and ankles and the longer bands are used at the chest and hips. B, figure 99 shows a method of placing the bands under a casualty at the small of the back.

4.51 Rescue from high places may sometimes be facilitated by using a sheave block on a rope or wire cable sloping from a high part of a building and anchored at or near the ground, particularly when the base of the structure is not suitable for the direct lowering of a casualty. (See fig. 100.) A stretcher with the casualty securely lashed, as described in paragraph 4.35, may be suspended from the running pulley. Two guidelines attached to the D's at the ends of the stretcher will guide and control the descent of the casualty. This technique is sometimes referred to as a "breeches buoy" or "Telpher line."

### **DISPOSITION OF CASUALTIES**

4.52 Casualties requiring further medical care should be properly tagged and turned over to field first aid, litter, or ambulance groups. This should be done as soon as possible after they have been freed from entrapment.

4.53 After all live casualties have been released, the recovery of bodies must be undertaken. This is an unpleasant task for which rescue squadmen must prepare themselves. Only squadmen temperamentally suited to such work should be assigned to it. Persons not directly concerned in the removal operations should be kept away. The squad or team leader should see that this is enforced and, if necessary, call on the police for assistance. Squadmen should wear rubber gloves when handling bodies and filter gas masks if odors are nauseating.

4.54 Casualties should be considered alive until declared dead by competent medical authority. However, there may be casualties with mutilations or other indications of death obvious even to a layman. In such cases bodies and parts of bodies should be appropriately tagged and turned over

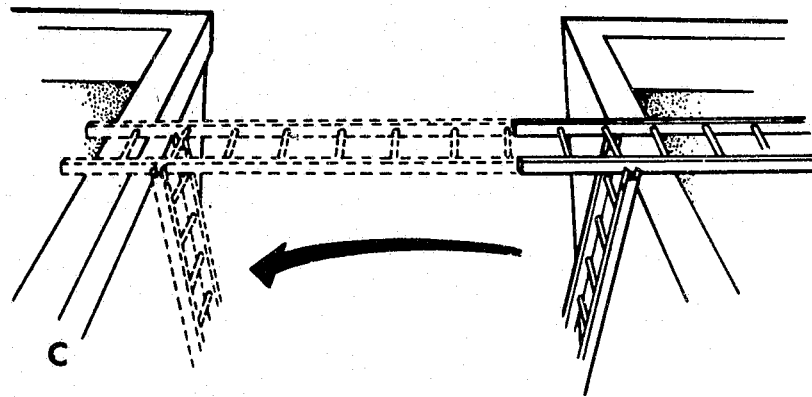
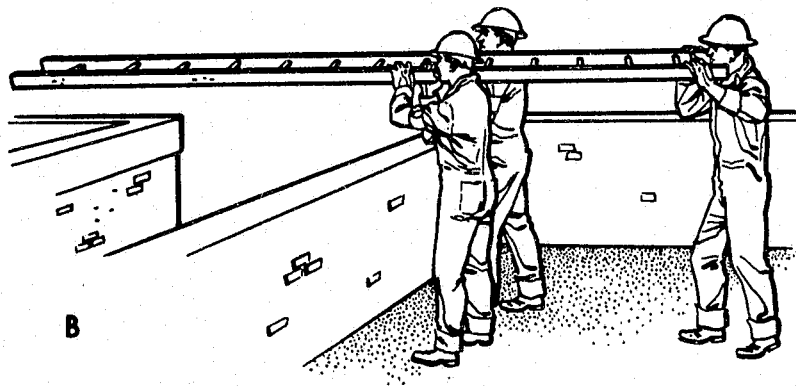
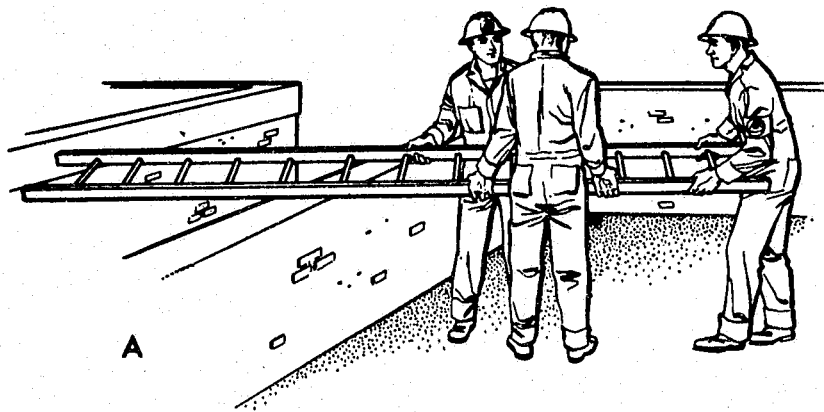
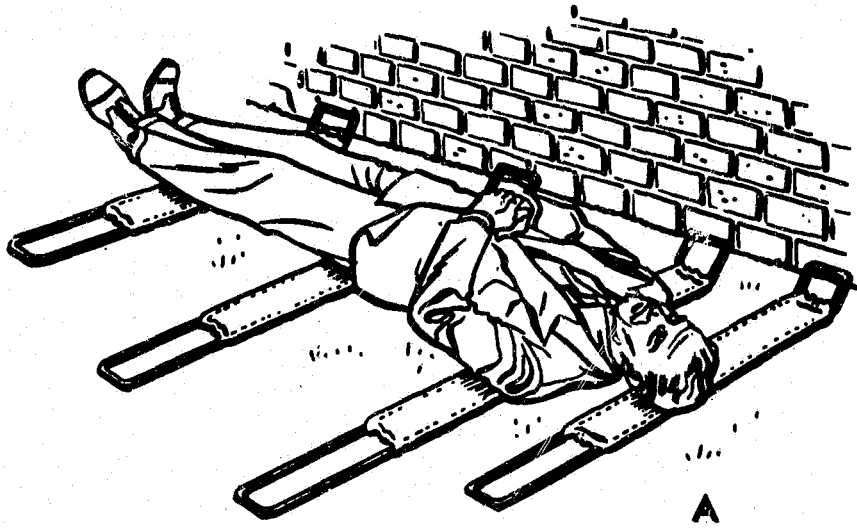
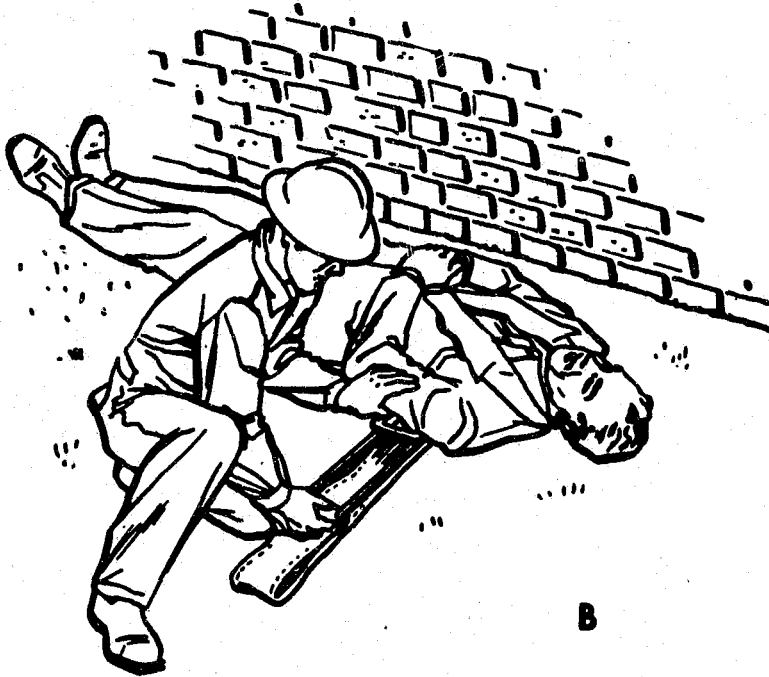

FIGURE 98.—Bridging gaps with ladders.



A



B

FIGURE 90.—Using webbing bands to move casualty.

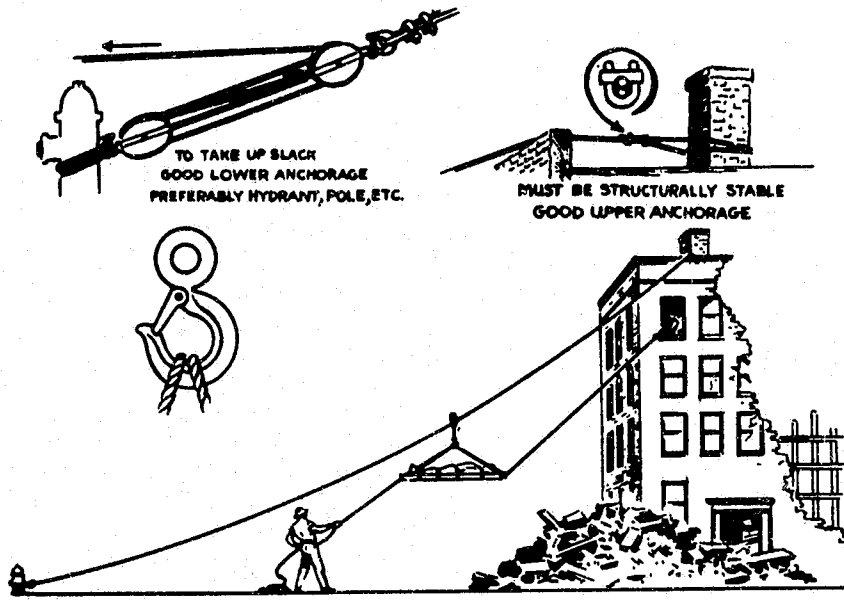

FIGURE 100.—Telpher line.

to the mortuary authorities as soon as possible. If there is a delay in collection, bodies should be covered with tarpaulins or blankets and placed in nearby buildings out of public view.

**TAGGING CASUALTIES**

4.55 Rescue squadmen are responsible for filling out an emergency medical tag and attaching it

to every casualty, living or dead, initially examined or treated by them.

4.56 Emergency medical tags like the sample shown in fig. 101 are recommended. The following symbols should be marked on the upper part of the face of the tag in large capital letters by rescue squadmen: L for litter case; H for a severe hemorrhage case; T for a tourniquet case (and

<b>EMERGENCY MEDICAL TAG</b>		Social No.
Name and home address of casualty		
Sex	Age	
Location when injured (describe exact location)		
Found at (describe exact location)		
Tagged	Date	Hour
Type of injury and treatment (by first-aid worker)		
Name of first-aid worker		
Diagnosis and treatment at first-aid station		
Sedation	Dose	Hours
Morphine	Dose	Hours
Dispensation	Date	Hours
Symbol of station	Signature—M. B.	

SUPPLEMENTAL RECORD	
FRONT	BACK

FIGURE 101.—Emergency medical tag.



time of application); and X for a dead person. Symbols should be approximately 3 inches high and 2 inches wide. They should be marked with colored or soft black lead pencil so they can be clearly recognized at a glance.

4.57 Tags should be provided with a string loop which can be fastened to some part of the casualty's body, preferably around the neck or wrist. They should not be attached to clothing or litters.

4.58 If emergency medical tags are not available, squadmen should use a piece of paper, record the same general information, and attach it to the casualty's body by any means possible.

4.59 Necessary information will not always be obtainable from casualties, especially if they are unconscious and have no identification on them. However, squadmen should try to complete the following information required on the first aid worker's part of the emergency medical tag:

(a) *Name*.—Print in this order: last name, first name, middle initial. If necessary, search for casualty's identification tag or identifying papers. If no identification is possible, leave blank.

(b) *Home address*.—Record if obtainable.

(c) *Sex and age*.—If the casualty cannot state age, write apparent age.

(d) *Location when injured; location where found; date and hour tagged*.<sup>2</sup>—Record carefully with the greatest possible accuracy. If the casualty is unconscious or dead, or is a small child, the location when injured may not be obtained directly. If this information is not available from others, fill in "unknown."

(e) *Type of injury and treatment by rescue squadman*.—Note briefly what appears to be wrong with casualty, such as: broken lower right leg, burned face, upper left arm wound, severe vomiting, and so forth, listing injuries in their apparent order of importance. Note briefly what was done for casualty, such as: splinted leg, dressed face burns, or applied pressure dressing to arm wound. If a tourniquet is used be sure to indicate that fact, and the time it was applied.

(f) *Name of first aid worker*.—Signature of squadman rendering first aid.

(g) The completely used or partially used book of tags containing the duplicates should be turned over to first aid station leaders when additional tag books are needed or when operations are concluded.

<sup>2</sup> The facts are of medical importance in relation to radiation exposure. They may also be useful in later identification of casualty.

## APPRECIATION OF DAMAGE TO BUILDINGS AND UTILITIES

### DAMAGE TO BUILDINGS

5.1 The type of construction of a building gives some indication of the way it may collapse as a result of blast. Depending on the distance from ground zero, almost all types of damaged structures will contain voids or spaces in which trapped persons may remain alive for comparatively long periods. To know where these safe places may be, it is necessary to know the characteristics of various types of construction.

5.2 *Framed structures* are of two types: (1) large multistoried framed buildings, such as hotels, office buildings, schools, hospitals, and loft buildings; and (2) smaller residential types of houses.

5.3 The larger multistoried framed structures are those having columns, beams, floor joists, and roof beams or trusses which support the weight of walls, partitions, and roof. They may be built of wood, steel, or concrete.

5.4 The smaller residential types of framed structures are usually limited to a height of two or three stories. The framework consists of posts or columns of wood, masonry, or steel in the basement, with wood or steel basement ceiling beams which, together with the exterior walls, support the upper floors and roof. The exterior walls are built with wood wall studs, exterior siding of wood sheathing, or masonry, and interior finish of lath and plaster. Floor joists and roof rafters are wood.

5.5 *Unframed or wall bearing buildings* are those in which the foundations and walls support the weight of floors, roof, and interior partitions which are not bearing walls. These structures are usually built of masonry walls with wood or steel floor joists and roof rafters.

5.6 Combinations of both framed and unframed construction may be found in industrial buildings or those having additions built to the original structure.

5.7 Framed structures generally withstand blast better than unframed buildings because of a tendency for the blast force to be distributed throughout the framing. Wall panels may be blown in or out without demolishing the frame, and floors may remain intact or only partially collapse. Debris and rubble will result from the blast, but not of the quantity and nature likely to result from an unframed building. Moreover, the prevalence of framed building construction in the United States indicates that the debris problem may not be relatively as great as that in European countries in World War II, and voids may exist in greater proportion.

5.8 Reinforcing rods and fire-distorted structural steel frames may create difficult and hazardous rescue problems. However, these materials will create many safe places from which people may be rescued. Rescue from framed structures may not be as difficult as from unframed buildings except, as these buildings are usually large and multistoried and contain many occupants, rescue of more people and from greater heights may present additional problems.

5.9 Extensive collapse may result from blast on unframed buildings. Where bearing walls are destroyed or damaged the floors are likely to collapse completely or become extremely dangerous. If bearing walls are damaged near their foundations, remaining upper parts of the walls are likely to be rendered unsafe. Large amounts of debris and rubble generally resulting from damaged masonry buildings cause rescue operations to be complicated and time consuming.

### TYPES OF COLLAPSE AND FORMATION OF VOIDS

5.10 When floor supports fail in any type building, the floors and roof may drop in large sections. These sections may form voids. If these sections remain in one piece and are supported on

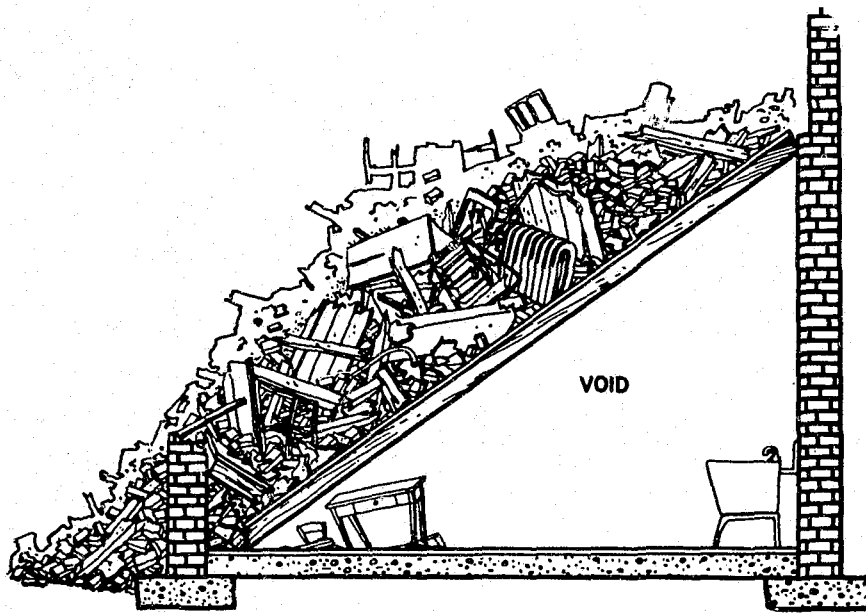

FIGURE 102.—Lean-to floor collapse.

one side, and are collapsed or sagged on the other, they form lean-to type collapses (fig. 102). The hanging collapse is a variation of the lean-to collapse, in that its lowest edge is not at rest, but is hanging free. In some cases a floor or roof section may be suspended from one of its four corners, rather than along an entire edge. Persons may be trapped in the voids thus created. The weakening or destruction of bearing walls may cause the floors and possibly the roof to collapse, one on top of the other, into a lower floor or the basement. This is referred to as a "pancake" collapse (fig. 103). Persons may be trapped between the layers of these "pancakes." When as

a result of collapse the weight of heavy loads, such as furniture and equipment, or rubble and debris, is concentrated near the center of a floor, a V-type collapse may occur (fig. 104). Heavy furniture may support a collapsed section of floor or wall, creating voids where casualties may be located.

5.11 Wood-framed dwellings generally collapse in very large panel sections. Walls, for example, come apart in panels composed of studs and siding, and floors break up in sections of joists and flooring still somewhat intact. Many protective voids are generally formed in this type of building collapse.

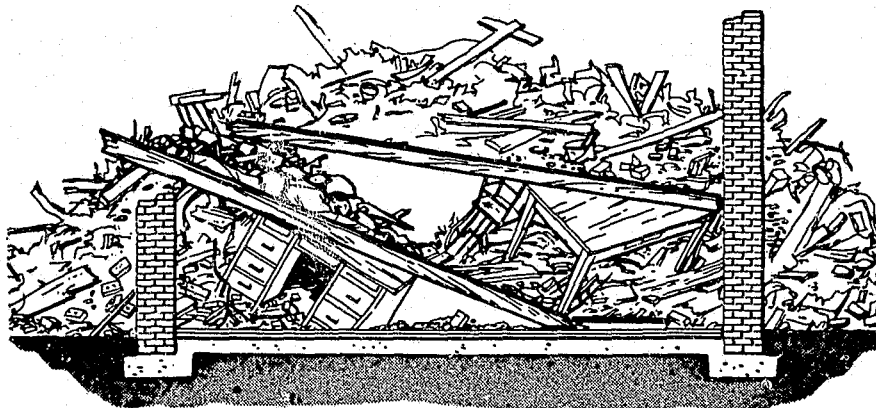

FIGURE 103.—Pancake floor collapse.

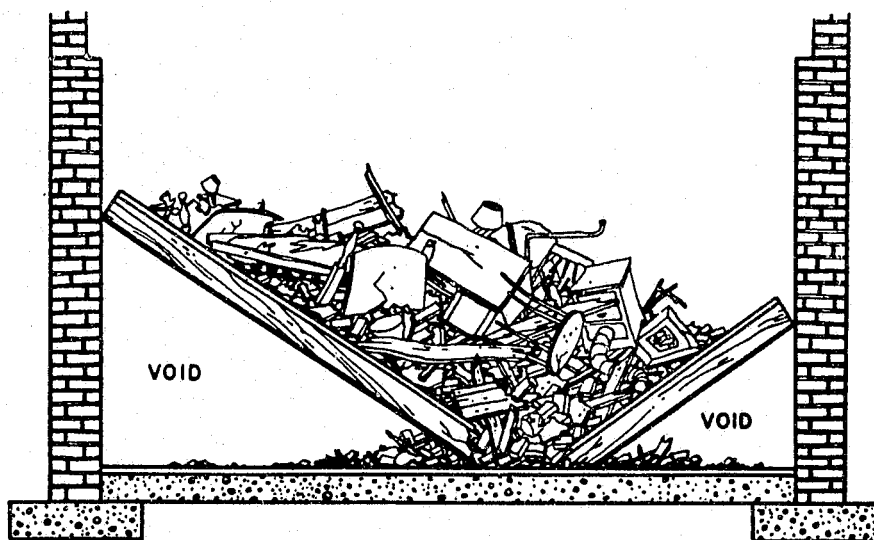

FIGURE 104.—V-shape floor collapse.

### PREATTACK INSPECTIONS

5.12 From the discussion above, it might be concluded that voids may be expected to occur in like buildings in a similar manner. However, many factors have a bearing on the nature of damage likely to result from blast. These factors may be determined prior to damage only by conducting preattack inspection of each building and taking note of features which may be of importance should rescue operations become necessary. Material obtained during shelter surveys may be helpful. A knowledge of the layout of each building is essential because after an attack it may be extremely difficult even to identify different rooms in seriously damaged buildings. These inspections will indicate that buildings having the same general plan will present different rescue problems. Alterations, placing of furniture, number of occupants, and relation to surrounding structures are some varying factors.

### HAZARDS FROM INDUSTRIAL CHEMICALS AND DAMAGED UTILITIES

5.13 The destruction of buildings and industrial facilities by bombing attack will invariably result in ruptured electrical, water, gas, and sewer lines. Other hazards will be escaping gases and chemicals used in refrigeration units and in certain industrial operations. These utilities create serious problems for casualties and rescue personnel. To insure maximum safety to both, squadmen

must have a knowledge of the hazards involved, as well as an understanding of utility supply line patterns.

5.14 Repair of utilities, maintenance of service, and capping of lines during civil defense emergencies are responsibilities of the utility companies, in cooperation with local government. However, certain emergency measures necessary to save a life may have to be taken by rescue squadmen. Information concerning utilities and emergency methods for shutting them off should be available from the utility companies and/or appropriate department of local government. Primarily, rescue squadmen should be instructed in the proper method of shutting off water, gas, and electricity and in the probable locations of shutoff valves and master switches. These locations may vary from one city to another, but they are reasonably consistent within a city. Information regarding the types and locations of dangerous chemicals and gases used by each industrial plant in the area should be obtained from the plant protection officials.

### WATER

5.15 Water from broken pipes may flood basements and other low areas, endangering trapped persons. Rescue personnel may shut off the flow of water at the watermeter or the street shutoff valves. This valve requires a special water key which should be procured locally as part of the squad equipment. Shutting down the larger water mains must be done by utility or public works engineers.

5.16 Pumping equipment for use in flooded areas may be provided by the utility concerned, or by the public works or fire department, when requested by the squad leader. Sandbags should be carried on the rescue truck. When filled, they may be used to divert the flow of water from a rescue area or to prevent flooding.

### DOMESTIC GAS

5.17 Escaping gas in basements and other confined areas of damaged buildings creates danger of explosion. Rescue squadmen should observe the following safety rules:

- (a) Never look for a suspected gas leak with a match or other open flame.
- (b) Never attempt to ignite a gas leak. This should be done only by experienced maintenance personnel.
- (c) Never smoke in areas where gas may be present or suspected.
- (d) Do not attempt to extinguish gas flames except by shutting off the gas.
- (e) Use the self-contained oxygen mask in areas containing gas.
- (f) Take every possible precaution to prevent igniting escaping gas. Sparks caused by the use of tools and power equipment can cause ignition.
- (g) Do not shut off large street gas mains. This should be done only by utility or public works maintenance crews.

5.18 Local policies and procedures for shutting off gas under emergency conditions should be followed by the rescue service. Information relative to the type of gas (natural or manufactured), special hazards involved, and system of distribution should be obtained. If special keys are necessary to shut off gas at the street they should be available to each rescue squad. The valve for each service connection is usually located at the meter and can be shut off with a pipe wrench or monkey wrench.

5.19 Rescue squadmen should locate gas shut-off valves for buildings in each block. Building attendants and plant protection chiefs should be able to assist in locating shutoff valves in apartments, industrial plants, and other large buildings.

### ELECTRICITY

5.20 Live wires present a serious hazard to trapped casualties and rescue personnel. Squadmen should observe the following precautions:

- (a) Assume all electric wires to be hot unless known to be dead. *The fact that wires do not sputter or spark is no indication that they are dead.*
- (b) Live wires should be handled only by persons trained in the proper procedures.
- (c) Never attempt to move wires on the ground, dangling from poles or trees, or hanging slack between poles, except when a life is at stake and then wires should be moved with dry objects that do not conduct electricity, such as lath hooks, boards, or ropes.
- (d) Avoid pools of water close to live wires—they may be just as dangerous as the wires. Avoid all other conductors, such as metal doors and wire fences that may be in contact with high voltage wires.
- (e) Never attempt to cut high-voltage wires. This should be done only by experienced maintenance crews.
- (f) Insulated wire cutters provided in rescue equipment should be used only to cut wires carrying ordinary house current.
- (g) The electric supply to a damaged building should be shut off at the master switch, usually located near the meter or fusebox.
- (h) Keep the rescue truck and other vehicles away from areas where wires are down.
- (i) Be especially cautious at night when it is difficult to see wires.

### SEWERS

5.21 Broken sewers may create problems of flooding and escaping gas. Dams can be improvised to divert the flow of broken sewers away from trapped casualties and rescue-working areas. Open flames should be avoided in the presence of sewer gas as it can be explosive as well as toxic. Rescue personnel should use the self-contained type breathing apparatus when working in areas contaminated with sewer gas.