

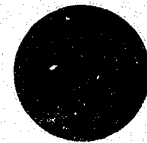

JULY 1998



---

**NASSAU COUNTY  
CRIMINAL JUSTICE  
COORDINATING COUNCIL**

---

**CRIME AND JUSTICE  
IN  
NASSAU COUNTY  
1979 - 1988**

125208

HON. THOMAS S. GULOTTA, COUNTY EXECUTIVE

EILEEN J. MASCIA, DEPUTY DIRECTOR

U.S. Department of Justice  
National Institute of Justice

This document has been reproduced exactly as received from the person or organization originating it. Points of view or opinions stated in this document are those of the authors and do not necessarily represent the official position or policies of the National Institute of Justice.

Permission to reproduce this copyrighted material has been granted by

Nassau County Criminal Justice  
Coordinating Council

to the National Criminal Justice Reference Service (NCJRS).

Further reproduction outside of the NCJRS system requires permission of the copyright owner.

We wish to acknowledge the cooperation in the development of this report of the Data Processing Bureau of the Nassau County Police Department, the assistance of William Dwyer and Jeffrey Colton of the District Attorney's Office, and Bob Giblin of the Bureau of Statistical Services, New York State Division of Criminal Justice Services.

Research development relative to this report was undertaken by Steven Martone, Fiscal Analyst, JoAnn Zahn, Research Analyst, Robert Weisse, Research Analyst and Edward T. Zelles, Research Coordinator who coordinated the development of this report. Each are to be commended for performing their assignments with dedication, scholarship and professionalism.

A special thanks to Jacqueline Mahoney for her typing of this report.

Eileen J. Mascia  
Deputy Director

TABLE OF CONTENTS

PART I		PAGE
APPENDIX A	Part I Offenses	1
	Summary of Crime Analysis	2-4
<u>SECTION I</u>	<u>INCIDENTS OF PART I MAJOR CRIMES</u>	5-12
TABLE I	Major Crimes Categories 1979 to 1988	5
	Graph, Total Crime, Burglary & Robbery 1979 to 1988	6
TABLE II	Crime rate per 100,000 Population	7
TABLE III	Comparison rate Nassau County/ New York State - Crime Rate Per 100,000 Population	8
TABLE IV	Clearance Rate/Part I Offenses Ten Year Analysis (1979-1988) in the Clearance of Part I Offenses	9 10-12
<u>SECTION II</u>	<u>IMPACT CRIMES</u>	13-20
	<u>ROBBERY</u>	
TABLE V	Location of Robberies	13
TABLE VI	Method of Robberies	14
TABLE VII	Handgun use in Robberies	15-16
	<u>BURGLARY</u>	
	Residential/Non-Residential Burglaries	17-20
<u>SECTION III</u>	<u>INCIDENTS OF PART II CRIME</u>	21-22
TABLE VIII	Part II Crimes 1979-1988	21
	Graph Part II Crimes	22
<u>SECTION IV</u>	<u>INCIDENCE OF CRIME TYPE BY COMMUNITY</u>	23-39
TABLE IX	Incidence of Crime Type by Community of Occurrence 1988 & 1987	24-35
	Total Criminal Incidents	36

TABLE X-A	Number of Incidents 1988 Community Rankings	37
TABLE X-B	Incidents per 1,000 Residents	38
TABLE X-C	Impact Crimes per 1,000 Residents	39
<u>SECTION V</u>	<u>ARRESTS</u>	40-51
TABLE XI	Total Arrest by Crime Type - Part I, Part II Nassau County	41-43
	Graph - Total Arrests Part I	44
	Graph - Total Arrests Part II	45
	Graph - Total Arrests Part I & Part II	46
	An Analysis of Arrestees	47
TABLE XI-A	Age of Arrestees	48
TABLE XI-B	Age of Persons Arrested by Crime	49
TABLE XI-C	Juvenile Arrestees of Part I Offenses	50
TABLE XII	Arrestee Characteristics - Sex, Race	51
APPENDIX B	COMMUNITY RANKING IMPACT CRIMES 1988-1987	52-59
PART II	<u>YOUTH OFFENSES</u>	60-66
	<u>ANALYSIS OF YOUTH ARRESTS</u>	60-61
TABLE I	Part I Arrests	62
TABLE II	Age & Sex Characteristics of Youthful Offenders	63
TABLE III	Arrest by Offenses 15 & Under	64
TABLE IV	Arrest by Offenses 16-21	65
APPENDIX A	Age Distribution 1970-1980	66

PART III	<u>ANALYSIS OF INMATE POPULATION</u> <u>NASSAU COUNTY CORRECTIONAL CENTER</u> <u>1984-1988</u>	67-70
TABLE I	Admission Characteristics -Sex -Race -Age -Education	68-69
TABLE II	Sentenced Characteristics -Age	70
PART IV	<u>FELONY CASE PROCESSING</u>	71-90
	<u>PREFACE</u> - Methodology of Part II Preparation	71
SECTION I	<u>OVERVIEW OF FELONY CASE PROCESSING</u> <u>FLOW</u>	72
	Graph One Nassau County Felony Processing Flow	73
TABLE IA	Total Felony Cases Processed	74
TABLE IB	Total Felony Cases Disposed	74
TABLE II	Types of Dispositions	75-76
TABLE III	Types of Dispositions All Felonies - County Court	77-78
TABLE IV	Types of Dispositions - Robbery, Burglary and Narcotics - County Court	79-81
TABLE V	Types of Sentences - All Felonies County Court	82
TABLE VI	Types of Sentences - Robbery, Burglary and Narcotics - County Court	83-85
	Graph Two Sentences on Conviction on Indictments & Superior Court Information - County Court - All Felonies	86
	Graph Three Sentences on Conviction on Indictments & Superior Court Information - County Court - All Robberies	87

	Graph Four Sentences on Conviction on Indictments & Superior Court Information - County Court - All Burglaries	88
	Graph Five Sentences on Conviction on Indictments & Superior Court Information - County Court - All Narcotics Cases	89
TABLE VII	Case Processing Time - County Court	90
<u>SECTION II</u>	<u>DISTRICT COURT ACTIVITY</u>	91-105
TABLE VIII	Types of Dispositions - Felonies District Court	92
TABLE IX	Types of Dispositions - Robbery, Burglary and Narcotics - District Court	93-95
TABLE X	Types of Sentences - Felonies - District Court	96
TABLE XI	Types of Sentences - Robbery - District Court	97
	Types of Sentences - Burglary - District Court	98
	Types of Sentences - Narcotics Cases - District Court	99
	Graph Six Sentences for Felonies Disposed of in District Court	100
	Graph Seven Sentences for Robberies Disposed of in District Court	101
	Graph Eight Sentences for Burglaries Disposed of in District Court	102
	Graph Nine Sentences for Narcotics Cases Disposed of in District Court	103
TABLE XII	Case Processing Time - District Court	104-105

SECTION III

ANALYSIS OF HIGH CHARGE AT  
ARREST VS. CHARGE AT CONVICTION 106

TABLE XIII

County Court Felony Convictions  
1984-1988 107-108

APPENDIX A  
PART I OFFENSES

- 1a. Murder and Non-Negligent Manslaughter
- 1b. Negligent Manslaughter
- 2. Rape:
  - Forcible Rape
  - Attempted Forcible Rape
- 3. Robbery:
  - Handgun
  - Other Firearm
  - Knife or Cutting Instrument
  - Other Dangerous Weapon
  - Strong-Arm
- 4. Assault:
  - Handgun
  - Other Firearm
  - Knife or Cutting Instrument
  - Strong-Arm
- 5. Burglary:
  - Forcible Entry
  - Unlawful Entry-No Force
  - Attempted Forcible Entry
- 6. Larceny-Theft (except motor vehicle theft)
- 7. Motor Vehicle Theft:
  - Automobiles
  - Trucks and Buses
  - Other Vehicles



## AN ANALYSIS OF PART I CRIME 1988

A number of observations can be made as a result of the Crime Analysis compiled by the Criminal Justice Coordinating Council.

- . Part I (MAJOR) Crime decreased by 1.6% from 1987 to 1988
- . VIOLENT CRIMES increased by 5.2% from 1987 to 1988
- . The CLEARANCE RATE for MAJOR CRIMES increased from 16.6% in 1987 to 19.7% in 1988. The CLEARANCE RATE increased for Burglary, (10.6% - 1987 vs. 16.1% in 1988) Robbery (29.2% - 1987 vs. 31.3% in 1988) and Motor Vehicle (9.6% - 1987 vs. 15.2% in 1988) over the prior year.
- . Overall PROPERTY CRIME decreased 2.1% from 1987 to 1988. There was a significant decrease (10.7%) in the number of Burglaries.
- . Of the 1,636 ROBBERIES in 1988, a handgun was used in 451 incidents and 94 of these incidents occurred in the street. This represents a 18.3% decrease when comparing the same factor to 1987.

## AN ANALYSIS OF THE TEN YEAR 1979-1988 TREND IN PART I CRIME

- . The total number of Part I (MAJOR) CRIMES for 1988 (43,777) as compared to 1979 (51,991) represents one of the lowest reported crimes in this ten year period.
- . We note that during this ten year period 1979-1988 there was an overall decrease of 15.8% in total crime. However, there was an increase of 49.8% in VIOLENT CRIMES, specifically the crimes of ROBBERY increased (26%), ASSAULT (82.3%) and RAPE (88.3%)
- . Our analysis also indicates that there was an increase of 85% when comparing VIOLENT CRIME to PROPERTY CRIME Ratio from 1979 (.0467) to 1988 (.0863)
- . For the period of 1979-1988 PROPERTY CRIME decreased by 18.9%. There were also significant decrease in BURGLARY (35.2%) and LARCENY (23.8%) during this ten year period.

AN ANALYSIS OF THE TEN YEAR 1979-1988 TREND CRIME RATE PER 100,000 POPULATION

- . A review of TABLE II, indicates that the total number of VIOLENT CRIMES per 100,000 has increased 101.5 per 100,000 when comparing 161.4 per 100,000 in 1979 to 262.9 per 100,000 in 1988.
- . In contrast, PROPERTY CRIME has decreased 371.7 per 100,000 when comparing 3417.6 per 100,000 in 1979 to 3045.9 per 100,000 in 1988.

AN ANALYSIS OF ROBBERY 1979-1988

- . A review of TABLE V indicates an increase of 26% in the incidence of ROBBERY when comparing 1979 to 1988. This increase can be attributed to the increase in the frequency of convenience stores (216%) and residential (98%) robberies.

AN ANALYSIS OF BURGLARY 1979-1988

- . An examination of TABLE I indicates a decrease of 35.2% from 1979-1988. This is the eighth consecutive year that the incidence of BURGLARY has declined from a high of 15,687 in 1980 to 8,094 in 1988.

AN ANALYSIS OF RESIDENTIAL BURGLARY 1981-1988\*

- . An examination of the eight year trend of BURGLARY in Nassau County indicates that Residential Burglaries continue to be the prime target.
- . When comparing 1981 (70%) to 1988 (60%) the percentage of Residential to total burglaries indicates a decline of Residential burglaries to total burglaries.

\* Prior years data not available

AN ANALYSIS OF PART II CRIME 1988

- . Part II Crimes showed no significant increase from 1987 to 1988
- . The following crimes showed significant increases from 1987 to 1988:

		<u>1987</u>	<u>1988</u>
Drug Offenses	(32.6%	2,282	3,026
Arson	(38.2%)	89	123
D.W.I.	(12.4%)	4,808	5,407

- We note a decrease in the following Part II Crimes when comparing 1987 to 1988:

		<u>1987</u>	<u>1988</u>
Criminal Mischief	(5.9%)	16,026	15,070
Burglar's Tools	(58.8%)	617	254

AN ANALYSIS OF THE TEN YEAR 1979-1988 TREND IN PART II CRIME

- An examination of TABLE VIII indicates that Part II incidents are down 2.7% from 1979 to 1988. However, there were significant increases in the following crimes:

Drug Offenses	(105.7%)
Sex Offenses	( 70.3%)
Stolen Property	( 78.1%)
Fraud	(264.8%)
D.W.I.	(102.4%)
Simple Assault	( 87.9%)

The following crimes decreased during the period of 1979 to 1988:

Arson	(46.8%)
Criminal Mischief	(23.2%)

The data which is the subejct of our analysis was provided by the New York State Division of Criminal Justice Services, the F.B.I.'s Uniform Crime Reporting System and the Nassau County Police Department.

SECTION I

INCIDENTS OF PART I

MAJOR CRIMES

As demonstrated in TABLE I; the reported total of 43,777 incidents in 1988 of PART I crimes remains one of the lowest total of reported crimes during the ten year period 1979-1988.

TABLE I  
\*NASSAU COUNTY  
MAJOR CRIME CATEGORIES 1979-1988

CRIME	1979	1980	1981	1982	1983	1984	1985	1986	1987	1988	%Change 1987-88	%Change 5 Yr. 1984-88	%Change 10 Yr. 1979-88	1988 NCPD ONLY
**MURDER	38	34	47	34	55	55	39	49	45	39	(13.3)	(29.1)	2.6	25
RAPE	77	74	83	94	113	126	138	137	142	145	2.1	15.1	88.3	86
ROBBERY	1,298	1,549	2,021	1,869	1,768	1,617	1,573	1,675	1,669	1,636	( 2.0)	1.2	26.0	1,042
ASSAULT	910	1,014	933	1,013	900	1,217	1,152	1,357	1,451	1,659	14.3	36.3	82.3	982
VIOLENT CRIMES	2,323	2,671	3,084	3,010	2,836	3,015	2,902	3,218	3,307	3,479	5.2	15.4	49.8	2,035
BURGLARY	12,498	15,687	15,481	12,136	11,079	9,623	9,456	9,093	9,068	8,094	(10.7)	(15.9)	(35.2)	5,895
LARCENY	31,269	30,298	29,784	27,768	25,313	26,106	27,141	24,777	25,286	23,839	( 5.7)	( 8.7)	(23.8)	18,088
AUTO THEFT	5,901	5,565	6,275	6,329	6,399	6,882	7,005	6,688	6,808	8,365	22.9	21.5	41.8	6,865
PROPERTY CRIME	49,668	51,550	51,550	46,233	42,791	42,611	43,602	40,558	41,162	40,298	( 2.1)	( 5.4)	(18.9)	30,848
VIOLENT/PROPERTY CRIME RATIO	.0467	.0518	.0598	.0651	.0662	.0707	.0665	.0793	.0803	.0863	-	-	-	.0659
TOTAL CRIME	51,991	54,221	54,624	49,243	45,627	45,626	46,504	43,776	44,469	43,777	( 1.6)	( 4.1)	(15.8)	32,883

\*Includes all data reported by the Nassau County Police, Independent and City Police Departments.

\*\*Includes Negligent and Non-Negligent Homicide.

**TOTAL CRIME**

\*\*\*\*\*

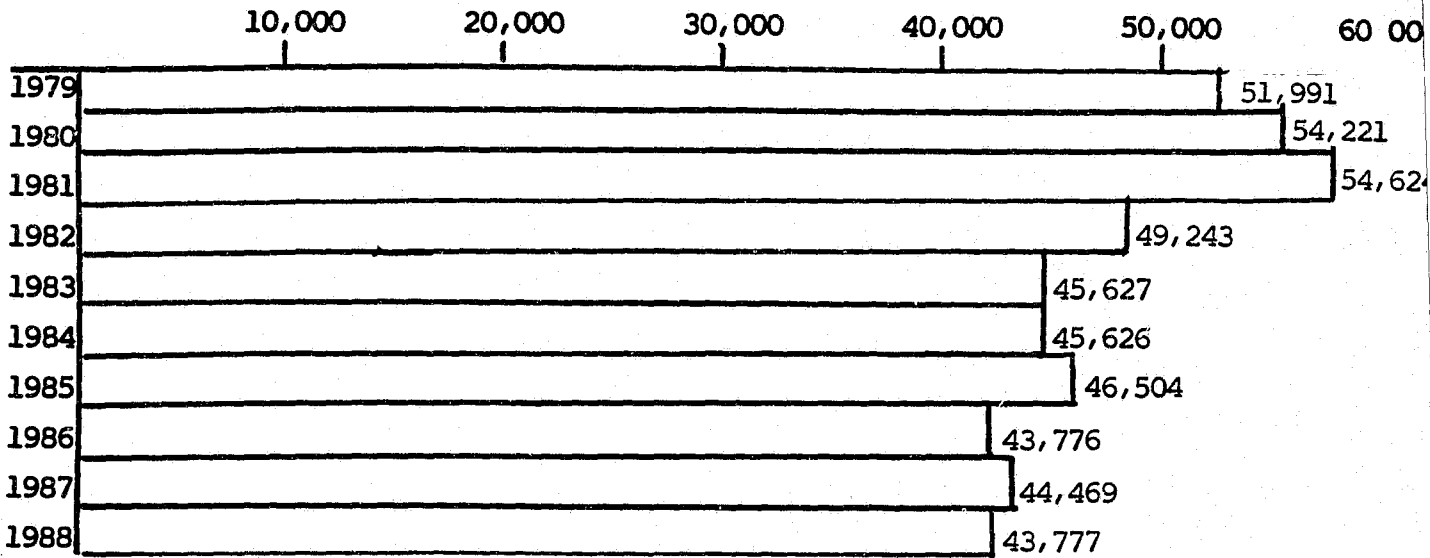

**BURGLARY**

\*\*\*\*\*

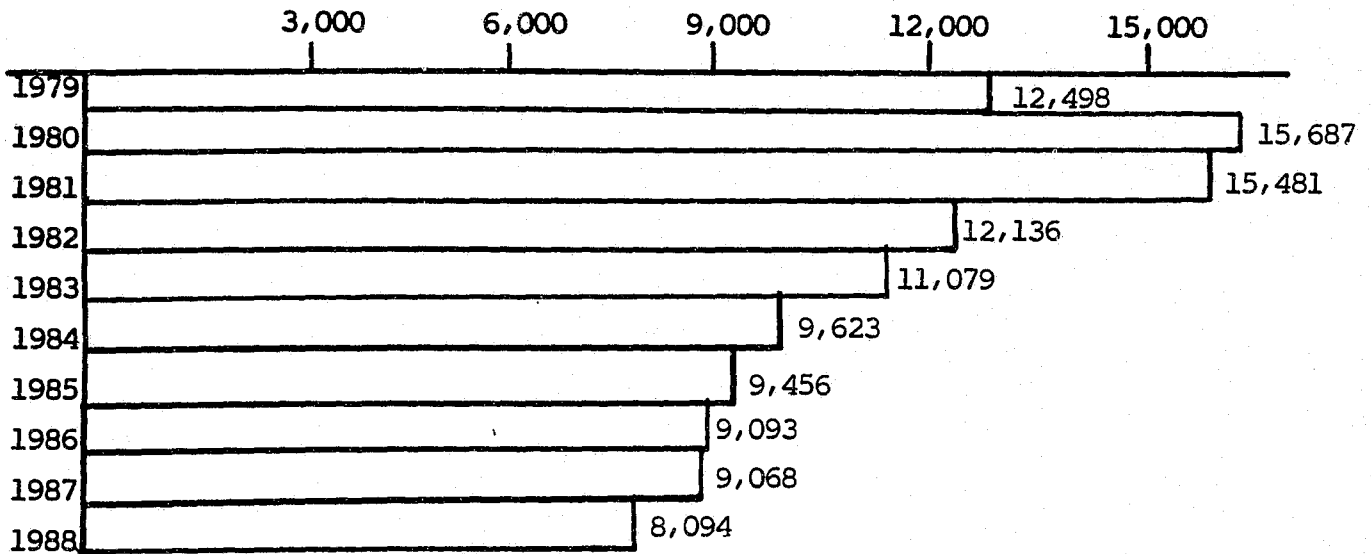

**ROBBERY**

\*\*\*\*\*

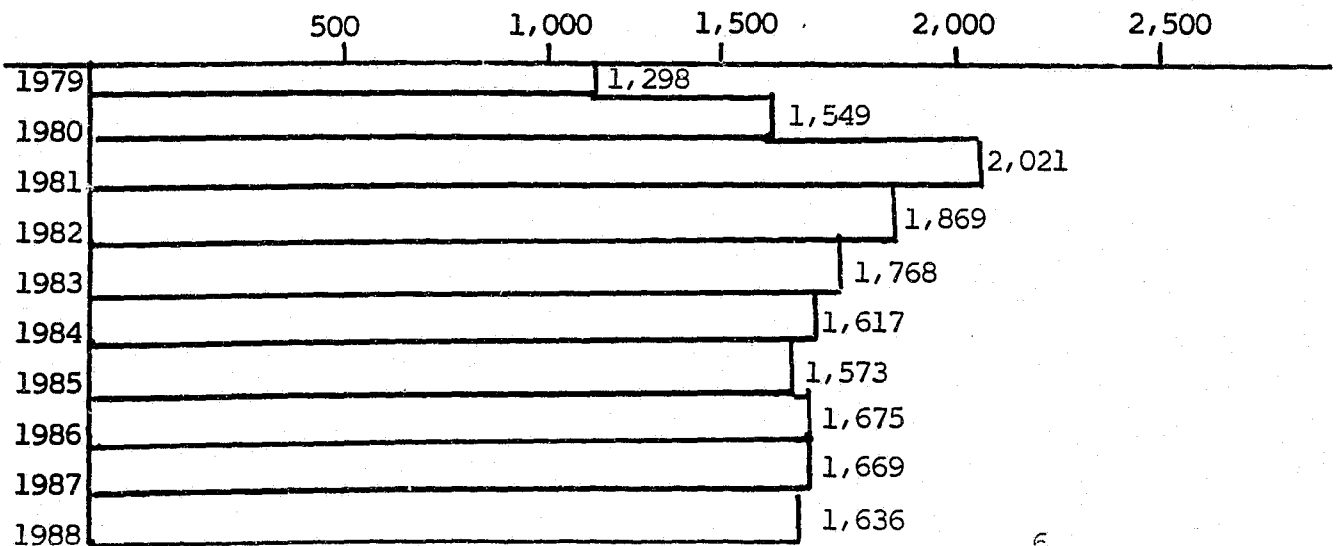

TABLE II

## CRIME RATE PER 100,000 POPULATION \*

Table II shows an illustration of the possibility of an average citizen being a victim of a crime in Nassau County.

CRIME	1979	1980	1981	1982	1983	1984	1985	1986	1987	1988
VIOLENT	161.4	202.1	234.4	230.6	217.4	231.2	222.6	245.8	251.2	262.9
PROPERTY	3417.6	3900.8	3918.3	3451.6	3283.2	3267.3	3343.1	3097.4	3127.1	3045.9
ROBBERY	90.5	117.2	153.6	143.2	135.6	124.	120.	127.9	126.8	123.7
BURGLARY	859.5	1187.	1176.6	929.9	850.	737.9	725.	694.4	688.9	611.8
PART I	3691.6	4108.4	4132.8	3726.0	3501.5	3498.2	3566.	3343.2	3378.3	3308.9
PART II	2784.1	2921.1	2828.7	2768.8	2658.2	2696.7	2801.9	2882.8	2887.6	2975.5
ALL OFF.	6362.1	7025.7	6982.6	6542.2	6159.7	6195.7	6368.3	6226.	6266.	6284.5

**NASSAU POPULATION	1979	-	1,453,309	1984	-	1,304,236
	1980	-	1,321,582	1985	-	1,304,236
	1981	-	1,315,685	1986	-	1,309,441
	1982	-	1,305,491	1987	-	1,316,308
	1983	-	1,303,389	1988	-	1,322,988

\*Includes all data reported by the Nassau County Police Department, Independent Village and City Police Departments. The CRIME RATE per 100,000 population as reflected in Table II is based upon Lilco estimated population figures which are slightly lower than the State estimate in Table III.

See Table III for CRIME RATE PER 100,000 which is based upon State estimated population figures.

\*\* LILCO Estimate

TABLE III

CRIME RATE PER 100,000\*  
1979-1988

	<u>1979</u>	<u>1980</u>	<u>1981</u>	<u>1982</u>	<u>1983</u>	<u>1984</u>	<u>1985</u>	<u>1986</u>	<u>1987</u>	<u>1988</u>	<u>%Change 1979-1988</u>
NEW YORK CITY	8587.5	10094.7	10278.8	9744.2	8822.4	8397.1	8392.9	8866.7	9033.5	9799.2	14.1
MONROE	6818.7	6987.7	6592.1	6325.8	5974.0	5353.0	5373.7	5370.3	5573.8	5722.8	(16.1)
SUFFOLK	5414.1	6196.7	5576.4	4909.8	4238.6	3813.6	3810.3	3871.8	4051.5	4249.4	(21.5)
ONONDAGA, SYRACUSE	5654.1	5567.6	5682.4	5097.1	4548.6	4448.5	4648.8	4638.0	5006.9	4736.8	(16.2)
ERIE/BUFFALO	4699.2	5346.8	5724.4	5037.3	4613.8	4422.2	4532.9	4591.7	4766.6	4774.0	1.6
WESTCHESTER/YONKERS	4561.3	5021.7	5026.0	4526.7	4022.0	3804.1	3841.0	4016.6	4110.2	4422.9	( 3.0)
NASSAU	3691.6	4108.4	4132.8	3726.0	3425.7	3426.0	3465.2	3263.7	3350.9	3311.8	(10.3)
TOTAL N.Y.S.	6097.0	6878.1	6903.6	6432.2	5836.2	5559.8	5566.7	5741.6	5931.5	6287.3	3.1

A review of this table shows that Nassau County has the lowest crime rate per 100,000 during the period of 1988 in comparison to other major populated areas in New York State.

A further review of TABLE III reveals that Nassau County has the lowest crime rate per 100,000 when comparing Nassau County to other major counties and towns during the period of 1979-1988.

\*SOURCE: Annual Report, New York State Division of Criminal Justice Services



CLEARANCE RATE PART I OFFENSES

An offense is cleared by arrest, or solved for crime reporting purposes, when at least one person is arrested, charged with commission of the offense and remanded to the courts for trial. As shown below Table IV examines the incidence and clearance rates for Part I Crimes in Nassau County for 1988.

TABLE IV  
CLEARANCE RATES FOR PART I OFFENSES

CRIME

	1988			NASSAU COUNTY P.D. ONLY 1988		
	<u>NO. OF INCIDENTS</u>	<u>NO. OF CLEARANCES</u>	<u>CLEARANCE RATE 1988%</u>	<u>NO. OF INCIDENTS</u>	<u>NO. OF CLEARANCES</u>	<u>CLEARANCE RATE 1988%</u>
MURDER	39	26	66.7	25	20	80.0
RAPE	145	69	47.6	86	47	54.7
ROBBERY	1,636	512	31.3	1,042	382	36.7
ASSAULT	1,659	1,016	61.2	882	667	75.6
BURGLARY	8,094	1,303	16.1	5,895	1,052	17.8
LARCENY	23,839	4,420	18.5	18,088	3,684	20.4
MOTOR VEHICLE	<u>8,365</u>	<u>1,268</u>	<u>15.2</u>	<u>6,865</u>	<u>1,099</u>	<u>16.0</u>
TOTAL	43,777	8,614	19.7%	32,883	6,951	21.1%

AN ANALYSIS OF THE TEN YEAR TREND 1979-1988 IN THE CLEARANCE OF PART I CRIMES

An examination of the ten year trend in the clearance of Part I crimes indicates that the clearance rate has increased from 13.6% in 1979 to 19.7% in 1988 while during the same period crime has dropped by 15.8%.

In the area of impact crime (Burglary & Robbery) the clearance rate over the ten year period has remained relatively constant for the clearance of those two crimes.

CRIME

	<u>1979</u>			<u>1980</u>		
	<u>NO. OF INCIDENTS</u>	<u>NO. OF CLEARANCES</u>	<u>CLEARANCE RATE%</u>	<u>NO. OF INCIDENTS</u>	<u>NO. OF CLEARANCES</u>	<u>CLEARANCE RATE%</u>
MURDER	38	33	86.8	34	30	88.2
RAPE	77	36	46.7	74	35	47.3
ROBBERY	1,298	369	28.4	1,549	429	27.7
ASSAULT	910	605	66.5	1,014	674	66.5
BURGLARY	12,498	1,940	15.5	15,687	2,705	17.2
LARCENY	31,269	3,714	11.9	30,298	3,765	12.4
MOTOR VEHICLE	<u>5,901</u>	<u>383</u>	<u>6.5</u>	<u>5,565</u>	<u>353</u>	<u>6.3</u>
TOTAL	51,991	7,080	13.6%	54,221	7,991	14.7%

CRIME

	<u>1981</u>			<u>1982</u>		
	<u>NO. OF INCIDENTS</u>	<u>NO. OF CLEARANCES</u>	<u>CLEARANCE RATE%</u>	<u>NO. OF INCIDENTS</u>	<u>NO. OF CLEARANCES</u>	<u>CLEARANCE RATE%</u>
MURDER	47	41	87.2	34	29	85.3
RAPE	83	41	49.4	94	32	34.
ROBBERY	2,021	405	20.	1,869	471	25.2
ASSAULT	933	583	62.5	1,013	690	68.1
BURGLARY	15,481	2,025	13.1	12,136	1,558	12.8
LARCENY	29,784	3,575	12.	27,768	3,781	13.6
MOTOR VEHICLE	<u>6,275</u>	<u>368</u>	<u>5.9</u>	<u>6,329</u>	<u>360</u>	<u>5.7</u>
TOTAL	54,624	7,038	12.9%	49,243	6,921	14.1%

CRIME

	<u>1983</u>			<u>1984</u>		
	<u>NO. OF INCIDENTS</u>	<u>NO. OF CLEARANCES</u>	<u>CLEARANCE RATE%</u>	<u>NO. OF INCIDENTS</u>	<u>NO. OF CLEARANCES</u>	<u>CLEARANCE RATE%</u>
MURDER	55	50	90.9	55	34	61.8
RAPE	113	56	49.6	126	55	43.7
ROBBERY	1,768	545	30.8	1,617	403	24.9
ASSAULT	900	625	69.4	1,217	831	68.3
BURGLARY	11,079	2,412	21.8	9,623	1,081	11.2
LARCENY	25,313	3,950	15.6	26,106	3,521	13.5
MOTOR VEHICLE	<u>6,399</u>	<u>551</u>	<u>8.6</u>	<u>6,882</u>	<u>645</u>	<u>9.4</u>
TOTAL	45,627	8,189	17.9%	45,626	6,570	14.4%

<u>CRIME</u>	<u>1985</u>			<u>1986</u>		
	<u>NO. OF INCIDENTS</u>	<u>NO. OF CLEARANCES</u>	<u>CLEARANCE RATE%</u>	<u>NO. OF INCIDENTS</u>	<u>NO. OF CLEARANCES</u>	<u>CLEARANCE RATE%</u>
MURDER	39	29	74.4	49	35	71.4
RAPE	138	69	50.	137	53	38.7
ROBBERY	1,573	415	26.4	1,675	453	27.
ASSAULT	1,152	754	65.5	1,357	809	59.6
BURGLARY	9,456	996	10.5	9,093	1,086	11.9
LARCENY	27,141	3,644	13.4	24,777	3,748	15.1
MOTOR VEHICLE	<u>7,005</u>	<u>719</u>	<u>10.3</u>	<u>6,688</u>	<u>540</u>	<u>8.1</u>
TOTAL	46,504	6,626	14.2%	43,776	6,724	15.4%

<u>CRIME</u>	<u>1987</u>			<u>1988</u>		
	<u>NO. OF INCIDENTS</u>	<u>NO. OF CLEARANCES</u>	<u>CLEARANCE RATE%</u>	<u>NO. OF INCIDENTS</u>	<u>NO. OF CLEARANCES</u>	<u>CLEARANCE RATE%</u>
MURDER	45	37	82.2	39	26	66.7
RAPE	142	75	52.8	145	69	47.6
ROBBERY	1,669	488	29.2	1,636	512	31.3
ASSAULT	1,451	862	59.4	1,659	1,016	61.2
BURGLARY	9,068	958	10.6	8,094	1,303	16.1
LARCENY	25,286	4,320	17.1	23,839	4,420	18.5
MOTOR VEHICLE	<u>6,808</u>	<u>652</u>	<u>9.6</u>	<u>8,365</u>	<u>1,268</u>	<u>15.2</u>
TOTAL	44,469	7,392	16.6%	43,777	8,614	19.7%

SECTION II

IMPACT CRIMES

SECTION II IMPACT CRIME\*

As shown in TABLE I the reported incidence of ROBBERY shows no significant change from 1987 to 1988.

TABLE V

<u>LOCATION OF ROBBERIES</u>											<u>%Change</u> <u>1987-1988</u>	<u>NCPD</u> <u>ONLY</u> <u>1988</u>
<u>LOCATION</u>	<u>1979</u>	<u>1980</u>	<u>1981</u>	<u>1982</u>	<u>1983</u>	<u>1984</u>	<u>1985</u>	<u>1986</u>	<u>1987</u>	<u>1988</u>		
HIGHWAY/STREET	627	705	970	1,052	924	647	680	742	686	656	( 4.4)	291
GAS STATION	107	120	251	227	194	219	188	167	226	155	(31.4)	130
CONVENIENCE STORE	97	148	148	117	84	246	213	265	242	307	26.8	285
BANKS	39	29	27	34	33	32	35	16	40	58	45.0	53
OTHER COMMERCIAL	277	350	364	277	260	46	60	48	48	89	85.4	56
RESIDENCE	86	119	154	114	79	121	121	117	157	170	8.3	99
MISCELLANEOUS	<u>65</u>	<u>78</u>	<u>107</u>	<u>48</u>	<u>194</u>	<u>306</u>	<u>276</u>	<u>320</u>	<u>270</u>	<u>201</u>	<u>25.6</u>	<u>128</u>
TOTAL	1,298	1,549	2,021	1,869	1,768	1,617	1,573	1,675	1,669	1,636	( 2.0)	1,042

\* Impact crime (Robbery and Burglary) have been identified by Nassau County as crimes meriting priority consideration because of the disruption of the lives of individuals who have been victimized.

TABLE VI

METHOD OF ROBBERIES										
TECHNIQUE	% 1979	NUMBER OF ROBBERIES	% 1980	NUMBER OF ROBBERIES	% 1981	NUMBER OF ROBBERIES	% 1982	NUMBER OF ROBBERIES	% 1983	NUMBER OF ROBBERIES
HANDGUNS	37.4	485	38.5	596	42.4	857	38.0	710	35.7	631
OTHER FIREARM	1.8	24	2.3	36	2.4	49	2.3	44	2.0	35
KNIFE	11.9	155	11.4	176	12.0	243	13.3	248	14.1	250
OTHER WEAPON	3.3	43	3.0	46	3.0	61	2.6	48	2.6	46
STRONG ARM*	45.5	<u>591</u>	44.9	<u>695</u>	40.1	<u>811</u>	43.8	<u>819</u>	45.6	<u>806</u>
		1,298		1,549		2,021		1,869		1,768

METHOD OF ROBBERIES								
TECHNIQUE	% 1984	NUMBER OF ROBBERIES	% 1985	NUMBER OF ROBBERIES	% 1986	NUMBER OF ROBBERIES	% 1987	NUMBER OF ROBBERIES
HANDGUN	36.7	594	31.7	499	31.8	533	26.5	442
OTHER FIREARM	3.1	50	2.2	35	2.1	36	2.1	35
KNIFE	13.2	213	13.2	208	12.7	213	17.8	297
OTHER WEAPON	21.6	350	22.9	361	21.6	361	19.2	320
STRONG ARM*	25.4	<u>410</u>	29.9	<u>470</u>	31.8	<u>532</u>	34.5	<u>575</u>
		1,617		1,573		1,675		1,669

METHOD OF ROBBERIES				NCPD ONLY
TECHNIQUE	% 1988	NUMBER OF ROBBERIES	% 1988	NUMBER OF ROBBERIES
HANDGUN	27.6	451	33.8	352
OTHER FIREARM	2.3	37	2.5	26
KNIFE	12.2	199	11.2	117
OTHER WEAPON	23.8	389	33.1	345
STRONG ARM*	34.2	<u>560</u>	19.4	<u>202</u>
		1,636		1,042

\*Strong arm is defined as those crimes committed without the display of a weapon.

TABLE VII\*

HANDGUN USAGE IN ROBBERIES

<u>LOCATION</u>	<u>1980</u>		<u>1981</u>		<u>1982</u>	
	NUMBER OF ROBBERIES INVOLVING HANDGUN	% OF ROBBERIES (HANDGUN) TO ALL ROBBERIES	NUMBER OF ROBBERIES INVOLVING HANDGUN	% OF ROBBERIES (HANDGUN) TO ALL ROBBERIES	NUMBER OF ROBBERIES INVOLVING HANDGUN	% OF ROBBERIES (HANDGUN) TO ALL ROBBERIES
STREET ROBBERIES	130	18.4	225	23.2	236	22.4
GAS STATIONS	81	67.5	176	70.1	147	64.8
CONVENIENCE STORES	104	70.3	96	64.9	76	65.0
BANKS	17	58.6	15	55.6	20	58.8
OTHER COMMERCIAL BUILDINGS	192	54.9	243	66.8	170	61.4
RESIDENCE	48	40.3	73	47.4	49	43.0
MISCELLANEOUS	24	30.8	29	27.1	12	25.0
TOTALS	596	38.5%	857	42.4%	710	38%
<u>LOCATION</u>	<u>1983</u>		<u>1984</u>		<u>1985</u>	
	NUMBER OF ROBBERIES INVOLVING HANDGUN	% OF ROBBERIES (HANDGUN) TO ALL ROBBERIES	NUMBER OF ROBBERIES INVOLVING HANDGUN	% OF ROBBERIES (HANDGUN) TO ALL ROBBERIES	NUMBER OF ROBBERIES INVOLVING HANDGUN	% OF ROBBERIES (HANDGUN) TO ALL ROBBERIES
STREET ROBBERIES	211	22.8	151	23.3	136	20.0
GAS STATIONS	126	64.9	131	59.8	99	52.7
CONVENIENCE STORES	52	61.9	142	57.7	113	53.1
BANKS	16	48.5	22	68.8	9	25.7
OTHER COMMERCIAL BUILDINGS	149	57.3	26	56.5	28	46.7
RESIDENCE	29	36.7	46	38.0	50	41.3
MISCELLANEOUS	48	24.7	76	24.8	64	23.2
TOTALS	631	35.7%	594	36.7%	499	31.7%

\* REFER TO TABLE V, Pg. 13



TABLE VII\*

HANDGUN USAGE IN ROBBERIES

<u>LOCATION</u>	<u>1986</u>		<u>1987</u>	
	<u>NUMBER OF ROBBERIES INVOLVING HANDGUN</u>	<u>% OF ROBBERIES (HANDGUN) TO ALL ROBBERIES</u>	<u>NUMBER OF ROBBERIES INVOLVING HANDGUN</u>	<u>% OF ROBBERIES (HANDGUN) TO ALL ROBBERIES</u>
STREET ROBBERIES	183	24.7	115	16.8
GAS STATIONS	87	52.1	91	40.3
CONVENIENCE STORES	114	43.0	117	48.3
BANKS	6	37.5	30	75.0
OTHER COMMERCIAL BUILDINGS	22	45.8	12	25.0
RESIDENCE	47	40.1	37	23.6
MISCELLANEOUS	74	23.1	40	14.8
TOTALS	533	31.8%	442	26.5%

<u>LOCATION</u>	<u>1988</u>		<u>NCPD 1988</u>	
	<u>NUMBER OF ROBBERIES INVOLVING HANDGUN</u>	<u>% OF ROBBERIES (HANDGUN) TO ALL ROBBERIES</u>	<u>NUMBER OF ROBBERIES INVOLVING HANDGUN</u>	<u>% OF ROBBERIES (HANDGUN) TO ALL ROBBERIES</u>
STREET ROBBERIES	94	14.3	45	15.5
GAS STATIONS	70	45.2	60	46.2
CONVENIENCE STORES	142	46.3	135	47.4
BANKS	37	63.8	34	64.2
OTHER COMMERCIAL BUILDINGS	21	23.6	16	28.6
RESIDENCE	44	25.9	32	32.3
MISCELLANEOUS	43	21.4	30	23.4
TOTALS	451	27.6%	352	33.8%

BURGLARY

Residences continued to be the main target of burglary in Nassau County comprising 60.4% of the total burglaries reported in 1988. Out of the 4,892 residential burglaries, 92% of the burglaries, where the time of occurrence could be determined, 59% occurred during the hours of 6 A.M. - 6 P.M. and 33% occurred during the hours of 6 P.M. - 6 A.M. 68% of non residential burglaries occurred during the hours of 6 P.M. - 6 A.M.

1988

<u>TYPE</u>	<u>FORCIBLE ENTRY</u>	<u>PERCENT</u>	<u>NO FORCE</u>	<u>PERCENT</u>
RESIDENTIAL	3,553	72.6%	942	19.3%
NON-RESIDENTIAL	2,540	79.3%	446	13.9%

<u>TYPE</u>	<u>ATTEMPT ONLY</u>	<u>PERCENT</u>	<u>NUMBER OF BURGLARIES</u>
RESIDENTIAL	397	8.1%	4,892
NON-RESIDENTIAL	216	6.7%	3,202

BURGLARY1987

<u>TYPE</u>	<u>FORCIBLE ENTRY</u>	<u>PERCENT</u>	<u>NO FORCE</u>	<u>PERCENT</u>
Residential	4,265	71.6%	1,159	19.5%
Non-Residential	2,498	80.3%	402	12.9%

<u>TYPE</u>	<u>ATTEMPT ONLY</u>	<u>PERCENT</u>	<u>NUMBER OF BURGLARIES</u>
Residential	533	8.9%	5,957
Non-Residential	211	6.8%	3,111

1986

<u>TYPE</u>	<u>FORCIBLE ENTRY</u>	<u>PERCENT</u>	<u>NO FORCE</u>	<u>PERCENT</u>
Residential	4,358	71.5%	1,225	20.1%
Non-Residential	2,300	76.8%	487	16.3%

<u>TYPE</u>	<u>ATTEMPT ONLY</u>	<u>PERCENT</u>	<u>NUMBER OF BURGLARIES</u>
Residential	516	8.5%	6,099
Non-Residential	207	6.9%	2,994

1985

<u>TYPE</u>	<u>FORCIBLE ENTRY</u>	<u>PERCENT</u>	<u>NO FORCE</u>	<u>PERCENT</u>
Residential	4,717	72.7%	1,211	18.7%
Non-Residential	2,347	79.1%	427	14.4%

<u>TYPE</u>	<u>ATTEMPT ONLY</u>	<u>PERCENT</u>	<u>NUMBER OF BURGLARIES</u>
Residential	560	8.6%	6,488
Non-Residential	194	6.5%	2,968

BURGLARY1984

<u>TYPE</u>	<u>FORCIBLE ENTRY</u>	<u>PERCENT</u>	<u>NO FORCE</u>	<u>PERCENT</u>
Residential	4,868	75.8%	1,017	15.8%
Non-Residential	2,531	79.2%	464	14.5%

<u>TYPE</u>	<u>ATTEMPT ONLY</u>	<u>PERCENT</u>	<u>NUMBER OF BURGLARIES</u>
Residential	541	8.4%	6,426
Non-Residential	202	6.3%	3,197

1983

<u>TYPE</u>	<u>FORCIBLE ENTRY</u>	<u>PERCENT</u>	<u>NO FORCE</u>	<u>PERCENT</u>
Residential	6,273	83.0%	445	6.0%
Non-Residential	3,236	91.8%	93	2.6%

<u>TYPE</u>	<u>ATTEMPT ONLY</u>	<u>PERCENT</u>	<u>NUMBER OF BURGLARIES</u>
Residential	836	11.1%	7,554
Non-Residential	196	5.6%	3,525

1982

<u>TYPE</u>	<u>FORCIBLE ENTRY</u>	<u>PERCENT</u>	<u>NO FORCE</u>	<u>PERCENT</u>
Residential	7,179	85.0%	422	5.0%
Non-Residential	3,353	90.9%	114	3.1%

<u>TYPE</u>	<u>ATTEMPT ONLY</u>	<u>PERCENT</u>	<u>NUMBER OF BURGLARIES</u>
Residential	847	10.0%	8,448
Non-Residential	221	6.0%	3,688

BURGLARY

1981

<u>TYPE</u>	<u>FORCIBLE ENTRY</u>	<u>PERCENT</u>	<u>NO FORCE</u>	<u>PERCENT</u>
Residential	9,108	84.1%	549	5.1%
Non-Residential	4,197	90.3%	133	2.9%

<u>TYPE</u>	<u>ATTEMPT ONLY</u>	<u>PERCENT</u>	<u>NUMBER OF BURGLARIES</u>
Residential	1,179	10.9%	10,836
Non-Residential	315	6.8%	4,645

SECTION III

INCIDENTS OF PART II CRIME

TABLE VIII  
 NASSAU COUNTY - PART II  
 INCIDENTS 1979-1988

CRIME	1979	1980	1981	1982	1983	1984	1985	1986	1987	1988	1988 NCPD ONLY	1987 NCPD ONLY
PART II												
ARSON	231	331	339	224	261	255	204	175	89	123	78	48
KIDNAPPING	6	2	2	1	0	10	15	12	12	11	4	7
DRUG OFFENSES	1,471	1,904	1,956	1,904	1,624	1,749	1,735	2,348	2,282	3,026	1,349	944
DANGEROUS WEAPONS	457	471	492	484	489	410	441	460	469	518	297	281
BRIBERY	4	6	3	5	2	5	14	3	14	20	13	10
SEX OFFENSES	273	271	308	262	279	518	596	510	446	465	308	316
EXTORTION	2	1	0	4	0	3	22	14	21	5	5	21
FORGERY & COUNTERFEITING	443	443	519	585	437	529	584	551	548	555	381	376
PROSTITUTION & VICE	95	68	69	119	117	192	238	607	235	466	42	32
STOLEN PROPERTY	606	674	610	691	618	603	754	916	899	1,079	522	397
COERCION	0	0	53	31	47	11	8	1	8	1	1	7
CRIMINAL MISCHIEF	19,610	17,897	16,500	14,647	14,517	14,434	14,554	14,803	16,026	15,070	11,702	12,223
FRAUD	105	131	177	170	160	259	347	298	284	383	305	211
GAMBLING	120	71	45	41	71	48	36	35	45	32	22	35
PUBLIC DISORDER	212	142	164	331	386	61	54	57	36	51	5	1
EMBEZZLEMENT	0	3	3	3	7	25	12	14	20	11	0	0
SIMPLE ASSAULT	1,462	1,624	1,572	1,529	1,863	2,715	2,295	2,543	2,581	2,747	2,120	1,999
FAMILY OFFENSES	239	226	206	239	419	373	364	323	260	247	3	4
D.W.I.	2,671	3,500	4,045	4,990	4,809	5,927	5,752	5,043	4,808	5,407	3,539	3,109
UNAUTHORIZED VEHICLE USE	2,517	*	*	306	337	472	562	427	617	254	64	49
BURGLAR'S TOOLS	57	78	86	71	61	62	111	47	65	36	20	31
LIQUOR LAW VIOLATIONS	26	40	49	42	78	35	66	20	43	47	0	0
DISORDERLY CONDUCT	1,583	1,590	1,358	1,440	1,253	1,352	1,806	1,580	1,587	1,835	337	343
PUBLIC NARCOTIC INTOX.	2	6	8	7	5	0	0	0	2	11	1	1
LOITERING	156	150	147	155	238	259	431	454	224	195	0	2
ALL OTHER	8,106	8,960	7,963	7,853	7,255	4,859	5,537	6,507	6,389	6,771	3,454	3,300
TOTAL	40,454	38,589	36,674	36,134	35,333	35,166	36,538	37,748	38,010	39,366	24,572	23,747

\* Not Reported

PART II INCIDENTS 1979-1988

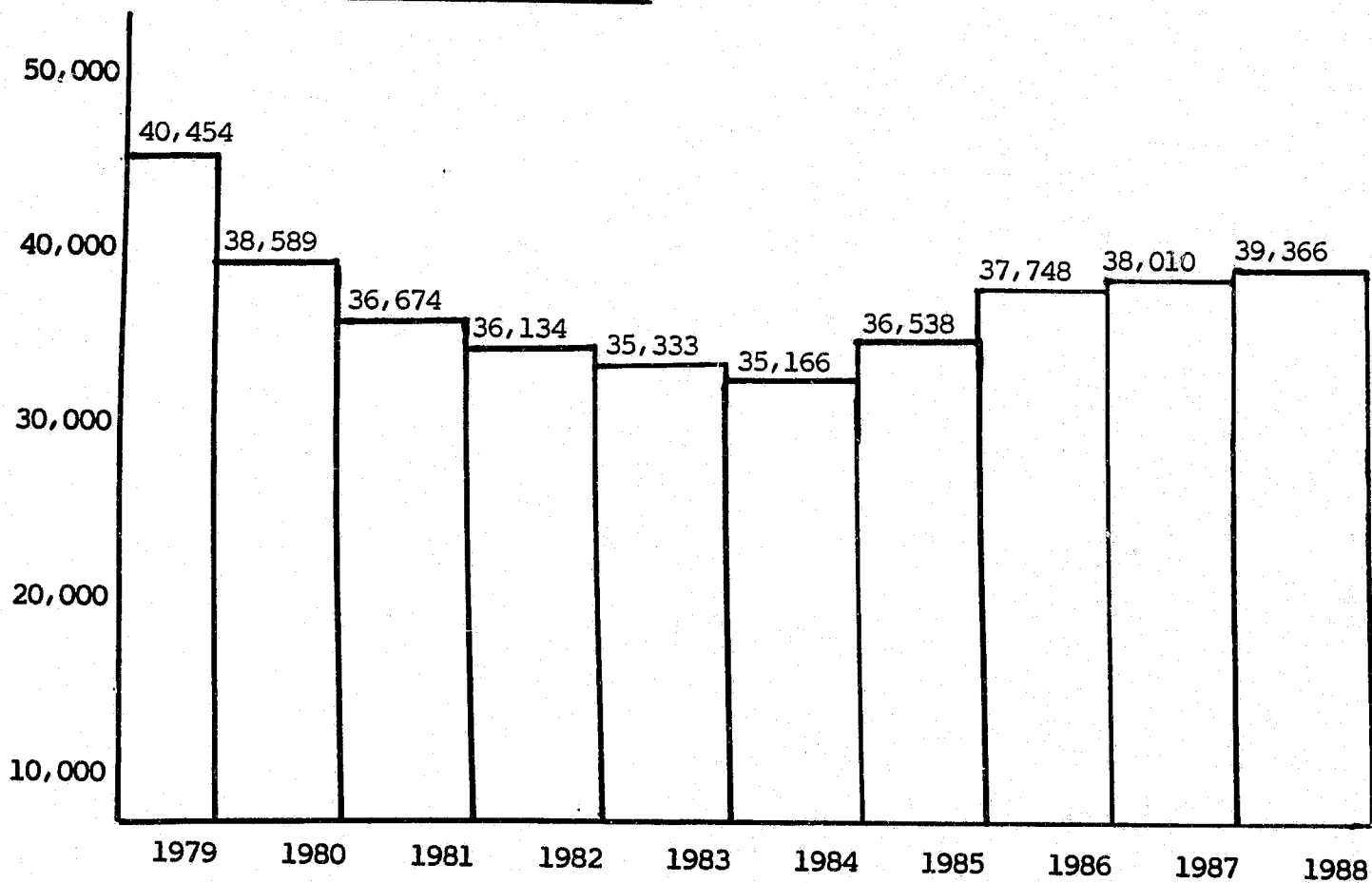



## SECTION IV

### INCIDENCE OF CRIME TYPE BY COMMUNITY

Table IX provides a record of criminal incidence by the community of occurrence. In order to compile the number of criminal incidents per community and then compare that analysis with the appropriate geographical/demographical locale it is necessary to utilize three complete sets of source documents. The communities are those as identified by the Nassau Police Department's location codes and are delineated as combined Incorporated Villages and Unincorporated statistical areas. The population data was arrived at from a LILCO estimate from Jan. 1, 1988 which in turn is based upon the April 1, 1980 census. The number of criminal incidence per community have been extrapolated from the Uniform Crime Reports of both the Independent Police Depts. and the Nassau County Police Dept.

Inconsistencies evident in the comparison of the above source documents do not obscure the essential validity for their use. In some cases communities or areas may exist for the N.C. Police Dept. crime reporting procedures but do not have separate data for census purposes. When this occurred several reports were analyzed and combined to obtain a "best fit" and these communities were then marked with footnotes.

We note in this analysis that in approaching the community by community analysis there are several factors that tend to detract from absolute reliability of such comparison. Two of these factors are: difference in definition or interpretation of what criminal incident occurred as recorded by different Police Depts. and differences in community boundaries as defined by the Nassau County Police Department and the U.S. Census Bureau.

TABLE IX  
1988 REPORTED INCIDENCE BY SELECTED CRIME  
BY COMMUNITIES OF OCCURRENCE

COMMUNITY	HOMICIDE	RAPE	ROBBERY	ASSAULT	BURGLARY	LARCENY	* UNAUTH. USE.	OTHER	TOTAL	POP.	** % CLEAR.
ALBERTSON	1	1	-0-	4	22	57	-0-	150	235	5,384	15.08
ATLANTIC BEACH	1	-0-	3	7	22	32	-0-	139	204	4,234	28.07
BALDWIN	2	4	38	48	136	253	8	1,015	1,504	31,380	25.26
BALDWIN HARBOR	-0-	-0-	-0-	1	2	2	1	11	17	-0-	11.76
BAY PARK	-0-	-0-	-0-	-0-	3	7	-0-	24	34	2,305	26.47
BAYVILLE	-0-	-0-	-0-	8	47	26	2	162	245	8,077	17.28
BELLEROSE	-0-	-0-	7	4	21	11	-0-	71	114	1,225	19.46
BELLEROSE TERRACE	-0-	-0-	5	5	9	23	1	86	129	1,928	20.93
BELLMORE	-0-	-0-	18	29	83	146	2	616	894	17,641	24.74
BETHPAGE	4	7	10	32	127	114	11	843	1,148	16,595	33.06
CARLE PLACE	1	-0-	19	14	74	202	3	395	708	5,243	27.41
CEDARHURST	-0-	1	18	12	76	180	1	350	638	5,880	20.91
CENTRE ISLAND	-0-	-0-	-0-	-0-	1	4	-0-	11	16	406	25.00
COVE NECK	-0-	-0-	-0-	-0-	1	5	-0-	1	7	339	14.28
E. GARDEN CITY	-0-	1	11	8	24	112	-0-	290	446	4,783	28.95
EAST HEMPSTEAD	-0-	-0-	1	-0-	5	5	-0-	29	40	-0-	45.00
EAST HILLS	-0-	-0-	7	2	48	53	1	135	246	6,850	21.39
E. MASSAPEQUA	-0-	-0-	2	16	35	70	-0-	227	350	13,334	33.13
EAST MEADOW	1	2	33	103	209	310	4	1,519	2,181	40,214	38.11
EAST NORWICH	-0-	-0-	1	2	13	14	1	53	84	2,712	34.52
EAST ROCKAWAY	1	-0-	1	9	31	53	1	261	357	10,530	30.87
EAST WILLISTON	-0-	-0-	-0-	2	6	4	-0-	34	46	2,614	30.43
ELMONT	1	6	54	96	234	453	13	1,406	2,263	27,290	34.80
FARMINGDALE	-0-	3	16	30	68	87	5	527	736	8,063	33.65
FLORAL PARK	-0-	-0-	13	3	65	168	6	230	485	16,311	23.91
FLORAL PARK CTR.	-0-	-0-	2	-0-	3	17	1	25	48	-0-	20.83
FLOWER HILL	-0-	-0-	3	1	30	35	-0-	83	152	4,582	21.71
FRANKLIN SQUARE	1	1	12	28	87	218	8	691	1,046	28,995	26.47
FREEPORT	5	9	175	117	365	753	-0-	1,104	2,528	38,668	37.18

\* UNAUTHORIZED USE OF MOTOR VEHICLE

\*\* CLEARANCE RATE PERCENTAGE

TABLE IX  
1988 REPORTED INCIDENCE BY SELECTED CRIME  
BY COMMUNITIES OF OCCURRENCE

COMMUNITY	HOMICIDE	RAPE	ROBBERY	ASSAULT	BURGLARY	LARCENY	* UNAUTH. USE	OTHER	TOTAL	POP.	** % CLEAR.
GARDEN CITY	-0-	-0-	9	15	141	236	3	640	1,044	21,996	30.74
GARDEN CITY PARK	2	-0-	9	10	44	123	3	292	483	7,747	25.31
GARDEN CITY SOUTH	-0-	-0-	-0-	4	5	19	-0-	59	87	4,037	16.09
GLEN COVE	-0-	3	14	68	148	388	62	1,211	1,894	26,150	27.71
GLEN HEAD	-0-	-0-	1	3	45	28	2	156	235	4,574	29.43
GLENWOOD LANDING	-0-	-0-	-0-	2	5	2	-0-	17	26	3,606	38.46
GREAT NECK	1	1	33	17	178	290	4	618	1,142	15,459	25.73
GREAT NECK ESTATES	-0-	1	1	1	18	44	-0-	36	101	2,790	8.91
GREAT NECK PLAZA	-0-	-0-	12	15	58	149	-0-	262	496	6,082	19.91
GREENVALE	-0-	-0-	3	2	18	52	2	116	193	3,634	32.98
HARBOR ISLE	-0-	-0-	-0-	-0-	3	3	-0-	16	22	-0-	23.80
HEMPSTAD	3	33	285	450	635	1,541	16	2,935	5,898	41,356	29.95
HERRICKS	-0-	1	1	-0-	2	10	-0-	45	59	7,748	32.75
HEWLETT	-0-	-0-	5	13	39	132	-0-	306	495	7,125	24.08
HEWLETT BAY PARK	-0-	-0-	-0-	-0-	1	1	-0-	20	22	469	22.72
HEWLETT HARBOR	-0-	-0-	-0-	-0-	2	13	1	23	39	1,235	5.26
HEWLETT NECK	-0-	-0-	-0-	-0-	-0-	4	-0-	5	9	446	0.00
HICKSVILLE	1	2	35	45	221	445	17	1,462	2,288	41,999	28.07
INWOOD	-0-	-0-	31	39	84	131	6	362	653	9,389	44.59
ISLAND PARK	1	-0-	2	12	28	46	2	150	241	9,527	35.41
JERICHO	1	1	9	7	85	214	3	559	879	13,588	29.27
KENSINGTON	-0-	-0-	1	-0-	1	15	-0-	19	36	1,129	2.77
KINGS POINT	-0-	-0-	2	-0-	23	60	3	26	114	5,247	4.38
LAKE SUCCESS	1	1	9	7	31	116	30	278	473	2,198	2.53
LAKEVIEW	-0-	-0-	14	43	46	27	5	138	273	5,274	50.00
LATTINGTOWN	-0-	-0-	-0-	-0-	4	8	-0-	33	45	2,049	27.27
LAUREL HOLLOW	-0-	-0-	-0-	-0-	8	15	-0-	19	42	1,667	4.76
LAWRENCE	-0-	1	13	8	39	134	-0-	302	497	6,174	27.58
LEVITTOWN	-0-	7	33	79	192	277	9	1,810	2,407	55,329	33.71
LIDO/PT. LOOKOUT	-0-	-0-	2	14	19	35	2	147	219	4,920	23.89
LOCUST VALLEY	-0-	-0-	1	7	55	24	-0-	103	190	3,459	18.51

\*UNAUTHORIZED USE OF MOTOR VEHICLE

\*\*CLEARANCE RATE PERCENTAGE

TABLE IX  
1988 REPORTED INCIDENCE BY SELECTED CRIME  
BY COMMUNITIES OF OCCURRENCE

COMMUNITY	HOMICIDE	RAPE	ROBBERY	ASSAULT	BURGLARY	LARCENY	* UNAUTH. USE.	OTHER	TOTAL	POP.	** % CLEAR.
LONG BEACH	-0-	3	23	24	263	635	38	1,886	2,872	36,087	40.80
LYNBROOK	-0-	-0-	11	20	102	280	2	420	835	19,623	16.76
MALVERNE	-0-	-0-	2	3	32	133	-0-	130	300	8,848	16.66
MALVERNE PARK	-0-	-0-	-0-	-0-	2	3	-0-	16	21	-0-	19.04
MANHASSET	1	1	18	18	73	215	2	500	828	8,509	24.87
MANHASSET HILLS	-0-	-0-	-0-	1	3	-0-	-0-	33	37	-0-	10.81
MANORHAVEN	-0-	-0-	-0-	11	9	29	-0-	110	159	5,802	30.32
MASSAPEQUA	-0-	1	11	38	159	220	12	1,092	1,533	23,650	26.17
MASSAPEQUA PARK	-0-	1	3	11	65	84	2	403	569	19,313	23.84
MERRICK	-0-	1	16	26	106	184	2	726	1,061	23,838	20.90
MILL NECK	-0-	-0-	-0-	1	3	3	-0-	16	23	1,019	8.69
MINEOLA	-0-	2	18	24	157	204	8	757	1,170	20,342	25.88
MUNSEY PARK	-0-	-0-	1	-0-	12	7	-0-	34	54	2,723	3.70
NEW CASSEL	-0-	4	24	86	73	65	5	645	902	10,685	71.49
NEW HYDE PARK	-0-	1	20	22	122	256	3	845	1,269	9,510	24.60
NORTH BALDWIN	-0-	-0-	-0-	1	2	-0-	-0-	5	8	-0-	37.50
NORTH BELLMORE	-0-	-0-	9	24	85	109	1	496	724	20,074	24.23
NORTH HILLS	-0-	-0-	2	3	7	37	-0-	158	207	3,063	59.70
NORTH LAWRENCE	-0-	1	18	8	36	105	-0-	303	471	-0-	42.52
N. LONG BEACH	-0-	-0-	3	21	17	37	1	267	346	-0-	51.61
NORTH LYNBROOK	-0-	-0-	-0-	-0-	1	6	-0-	13	20	-0-	25.00
N. MASSAPEQUA	1	-0-	4	17	76	114	-0-	520	732	20,981	18.10
NORTH MERRICK	-0-	-0-	14	18	61	86	2	313	494	12,520	27.25
N. NEW HYDE PARK	-0-	-0-	10	6	41	177	1	294	529	14,526	16.76
NORTH SEAFORD	-0-	-0-	-0-	-0-	8	8	-0-	30	46	-0-	17.39
N. VALLEY STREAM	2	-0-	2	11	44	128	2	178	367	14,297	16.98
N. WANTAGH	-0-	-0-	-0-	1	8	13	-0-	42	64	13,079	17.18
N. WOODMERE	-0-	-0-	7	5	12	108	-0-	125	257	-0-	18.75
OCEANSIDE	1	2	11	39	138	246	8	1,011	1,456	33,625	33.40

\* UNAUTHORIZED USE OF MOTOR VEHICLE

\*\* CLEARANCE RATE PERCENTAGE

TABLE IX  
1988 REPORTED INCIDENCE BY SELECTED CRIME  
BY COMMUNITIES OF OCCURRENCE

COMMUNITY	HOMICIDE	RAPE	ROBBERY	ASSAULT	BURGLARY	LARCENY	* UNAUTH. USE	OTHER	TOTAL	POP.	** % CLEAR.
OLD BETHPAGE	-0-	-0-	1	2	32	18	-0-	97	150	6,354	19.59
OLD BROOKVILLE/ BROOKVILLE/UPPER BROOKVILLE	-0-	2	1	7	67	169	2	307	555	7,109	10.81
OLD WESTBURY	1	-0-	3	4	36	48	1	128	221	3,607	24.88
OYSTER BAY	-0-	-0-	1	12	33	47	-0-	182	275	7,484	28.88
OYSTER BAY COVE	-0-	1	-0-	-0-	17	2	1	9	30	2,319	23.33
PLAINEDGE	-0-	-0-	-0-	2	4	3	-0-	35	44	9,423	39.53
PLAINVIEW	-0-	1	15	22	175	194	3	756	1,166	27,813	23.23
PLANDOME	-0-	-0-	-0-	1	6	5	-0-	12	24	1,462	16.66
PLANDOME HEIGHTS	-0-	-0-	-0-	-0-	10	4	-0-	4	18	955	5.55
PLANDOME MANOR	-0-	-0-	-0-	-0-	2	3	-0-	13	18	935	27.77
PORT WASHINGTON <sup>1</sup>	1	-0-	7	14	53	393	2	1,097	1,567	19,693	43.39
ROCKVILLE CENTRE	1	-0-	18	16	161	490	1	641	1,328	24,999	16.71
ROOSEVELT	6	12	55	166	222	163	11	1,226	1,861	14,751	60.46
ROSLYN	-0-	-0-	-0-	3	36	57	-0-	130	226	2,271	17.48
ROSLYN ESTATES	-0-	-0-	2	1	9	3	-0-	42	57	1,236	16.36
ROSLYN HARBOR	-0-	-0-	-0-	1	5	14	-0-	21	41	1,150	36.58
ROSLYN HEIGHTS	1	-0-	10	9	74	132	3	300	529	6,280	27.53
RUSSELL GARDENS	1	-0-	-0-	-0-	6	5	-0-	9	21	1,348	19.04
SADDLE ROCK	-0-	1	-0-	-0-	4	3	-0-	16	24	954	4.54
SANDS POINT	-0-	-0-	-0-	-0-	11	19	-0-	17	47	2,735	8.51
SEA CLIFF	-0-	-0-	-0-	4	41	22	-0-	121	188	5,423	20.21
SEAFORD	-0-	1	8	27	80	126	1	604	847	15,959	28.05
SEARINGTOWN	-0-	-0-	2	3	25	27	-0-	68	125	5,206	12.80
S. FARMINGDALE	-0-	1	4	24	39	50	-0-	263	381	15,743	21.75
S. FLORAL PARK	-0-	-0-	-0-	2	3	1	3	15	24	1,649	12.50
S. HEMPSTEAD	-0-	-0-	2	2	10	24	-0-	70	108	3,208	8.41
S. VALLEY STREAM	-0-	-0-	-0-	1	6	43	-0-	25	75	5,188	10.66

\* UNAUTHORIZED USE OF MOTOR VEHICLE

\*\* CLEARANCE RATE PERCENTAGE

1. Includes Baxter Estates, Port Washington North, NorthEast and North West.

TABLE IX  
1988 REPORTED INCIDENCE BY SELECTED CRIME  
BY COMMUNITIES OF OCCURRENCE

COMMUNITY	HOMICIDE	RAPE	ROBBERY	ASSAULT	BURGLARY	LARCENY	* UNAUTH. USE.	OTHER	TOTAL	POP.	** % CLEAR.
S. WESTBURY <sup>2</sup>	-0-	-0-	-0-	-0-	-0-	-0-	-0-	-0-	-0-	9,438	-0-
STEWART MANOR	-0-	-0-	1	1	6	3	-0-	27	38	2,483	36.84
SYOSSET	-0-	-0-	10	14	134	184	6	700	1,048	10,366	22.22
THOMASTON	-0-	-0-	2	2	25	15	-0-	44	88	2,634	23.80
UNIONDALE	2	13	47	74	155	221	8	753	1,273	19,518	34.45
VALLEY STREAM	1	4	42	40	205	569	23	1,230	2,114	34,674	27.22
WANTAGH	-0-	1	16	26	127	174	6	901	1,251	20,397	25.00
W. FARMINGDALE	-0-	-0-	-0-	-0-	-0-	-0-	-0-	5	5	-0-	20.00
WEST HEMPSTEAD	-0-	2	20	47	90	198	-0-	739	1,096	18,054	29.29
WESTBURY	1	6	32	56	254	380	12	1,035	1,776	13,877	27.24
WILLISTON PARK	-0-	-0-	2	9	21	65	-0-	320	417	7,821	28.98
WOODBURY	-0-	1	2	12	38	106	2	272	433	7,941	23.31
WOODMERE	-0-	2	5	8	36	178	2	300	531	16,043	21.94
WOODSBURGH	-0-	-0-	1	1	4	7	-0-	19	32	834	18.75

\* UNAUTHORIZED USE OF MOTOR VEHICLE

\*\*CLEARANCE RATE PERCENTAGE

2. For reporting purposes NCPD includes any incidents of crime in the Community of Westbury.

TABLE IX  
1988 REPORTED INCIDENCE BY SELECTED CRIME  
BY OTHER AREAS OF OCCURRENCE

COMMUNITY	HOMICIDE	RAPE	ROBBERY	ASSAULT	BURGLARY	LARCENY	* UNAUTH. USE.	OTHER	TOTAL	POP.	** %	CLEAR.
BELMONT RACE TRACK	-0-	-0-	2	6	5	8	1	41	63	-0-		58.73
EISENHOWER PARK	-0-	-0-	-0-	1	3	6	1	19	30	-0-		36.66
GREEN ACRES SHOPPING CENTER	2	1	36	8	13	426	1	1,007	1,494	-0-		59.98
MID ISLAND SHOPPING CENTER	-0-	-0-	5	2	2	95	-0-	143	247	-0-		36.73
MITCHEL FIELD	-0-	-0-	-0-	-0-	-0-	5	-0-	12	17	-0-		58.82
NASSAU COLISEUM	1	-0-	22	19	-0-	24	-0-	73	139	-0-		41.60
ROOSEVELT FIELD	1	1	17	13	27	387	1	720	1,167	-0-		37.32
ROOSEVELT RACEWAY	-0-	-0-	1	3	5	18	-0-	9	36	-0-		22.85
SEARS SHOP CTR.	-0-	-0-	4	2	2	21	-0-	93	122	-0-		50.00
SUNRISE CINEMA	-0-	-0-	7	6	-0-	66	-0-	69	148	-0-		29.25
SUNRISE MALL, MASS.	-0-	1	9	15	18	225	-0-	609	877	-0-		53.66

\* UNAUTHORIZED USE OF MOTOR VEHICLE

\*\* CLEARANCE RATE PERCENTAGE

TABLE IX  
1987 REPORTED INCIDENCE BY SELECTED CRIME  
BY COMMUNITIES OF OCCURRENCE

COMMUNITY	HOMICIDE	RAPE	ROBBERY	ASSAULT	BURGLARY	LARCENY	* UNAUTH. USE.	OTHER	TOTAL	POP.	** % CLEAR.
ALBERTSON	-0-	-0-	3	1	52	37	9	162	264	5,339	12.97
ATLANTIC BEACH	-0-	1	-0-	8	44	29	5	157	244	4,190	24.58
BALDWIN	-0-	3	28	39	197	167	65	977	1,476	31,337	20.38
BALDWIN HARBOR	-0-	-0-	-0-	-0-	4	1	3	12	20	-	30.00
BAY PARK	-0-	-0-	-0-	2	4	1	3	36	46	2,299	28.26
BAYVILLE	-0-	-0-	1	12	44	18	9	171	255	8,000	21.91
BELLEROSE	-0-	-0-	5	2	16	8	2	58	91	1,224	20.22
BELLEROSE TERRACE	-0-	-0-	2	3	7	12	9	57	90	1,930	17.04
BELLMORE	-0-	1	10	21	79	99	33	637	880	17,565	22.13
BETHPAGE	-0-	5	11	37	142	84	28	873	1,180	16,567	30.85
CARLE PLACE	-0-	2	11	15	47	176	41	395	688	5,224	31.63
CEDARHURST	-0-	-0-	12	11	62	105	23	319	532	5,896	17.58
CENTRE ISLAND	-0-	-0-	-0-	-0-	-0-	4	-0-	2	6	400	50.00
COVE NECK	-0-	-0-	-0-	-0-	-0-	9	-0-	-0-	9	335	11.11
EAST GARDEN CITY	-0-	1	4	16	38	92	40	339	530	4,243	24.47
EAST HEMPSTEAD	-0-	1	-0-	-0-	4	7	-0-	40	52	-	36.53
EAST HILLS	1	-0-	4	6	72	48	6	176	313	6,857	18.77
EAST MASSAPEQUA	1	3	6	11	40	46	20	203	331	13,340	29.87
EAST MEADOW	1	3	30	96	212	238	97	1,596	2,273	39,834	37.17
EAST NORWICH	-0-	-0-	1	2	17	11	4	75	110	2,700	30.00
EAST ROCKAWAY	-0-	-0-	7	17	33	40	10	233	341	10,529	24.17
EAST WILLISTON	-0-	-0-	-0-	-0-	7	6	1	36	50	2,614	12.24
ELMONT	1	3	74	89	230	249	109	1,363	2,118	27,201	32.98
FARMINGDALE	-0-	2	10	34	90	62	31	546	775	7,998	32.28
FLORAL PARK	-0-	-0-	10	12	54	213	52	184	525	16,322	19.42
FLORAL PARK CENTRE	-0-	-0-	-0-	1	3	8	6	42	60	-	16.94
FLOWER HILL	-0-	1	3	-0-	47	30	5	85	171	4,578	17.64
FRANKLIN SQUARE	-0-	1	19	27	107	135	42	651	982	28,646	27.20
FREEPORT	3	13	156	75	462	1,222	269	725	2,925	38,641	27.72

\* UNAUTHORIZED USE OF MOTOR VEHICLE

\*\*CLEARANCE RATE PERCENTAGE



TABLE IX  
1987 REPORTED INCIDENCE BY SELECTED CRIME  
BY COMMUNITIES OF OCCURRENCE

COMMUNITY	HOMICIDE	RAPE	ROBBERY	ASSAULT	BURGLARY	LARCENY	* UNAUTH. USE.	OTHER	TOTAL	POP.	** % CLEAR.
GARDEN CITY	-0-	1	15	25	151	380	87	573	1,232	21,998	21.91
GARDEN CITY PARK	-0-	-0-	11	14	52	78	15	335	505	7,746	28.57
GARDEN CITY SOUTH	-0-	1	1	1	10	4	3	52	72	4,043	25.71
GLEN COVE	1	2	19	49	176	310	61	1,069	1,687	25,733	25.01
GLEN HEAD	-0-	1	1	6	34	16	3	113	174	4,513	25.29
GLENWOOD LANDING	-0-	-0-	1	1	1	2	1	23	29	3,597	31.03
GREAT NECK	-0-	1	31	21	161	212	66	625	1,117	15,502	22.90
GREAT NECK ESTATES	-0-	-0-	-0-	-0-	13	60	5	73	151	2,794	7.28
GREAT NECK PLAZA	-0-	-0-	4	5	36	85	15	280	425	6,029	16.42
GREENVALE	-0-	-0-	4	3	12	58	10	141	228	1,056	30.49
HARBOR ISLE	-0-	-0-	-0-	1	6	4	1	25	37	-	27.02
HEMPSTEAD	10	27	315	411	706	1,480	191	2,245	5,385	41,389	29.15
HERRICKS	-0-	-0-	1	1	8	16	4	49	79	7,761	20.77
HEWLETT	-0-	3	9	11	45	67	19	323	477	7,127	24.15
HEWLETT BAY PARK	-0-	-0-	1	1	5	10	4	15	36	464	22.22
HEWLETT HARBOR	-0-	1	-0-	1	2	10	1	32	47	1,240	19.14
HEWLETT NECK	-0-	-0-	-0-	-0-	-0-	1	-0-	7	8	449	0.00
HICKSVILLE	1	3	30	57	250	281	112	1,415	2,149	41,824	28.80
INWOOD	-0-	4	30	26	86	68	25	305	544	9,196	35.56
ISLAND PARK	1	1	3	12	18	29	22	184	270	9,505	33.58
JERICHO	-0-	-0-	12	11	90	126	44	584	867	13,347	23.60
KENSINGTON	-0-	-0-	2	1	8	15	1	21	48	1,124	8.33
KINGS POINT	-0-	-0-	-0-	1	31	64	3	15	114	5,245	4.38
LAKE SUCCESS	-0-	-0-	2	11	46	140	28	240	467	2,198	2.78
LAKEVIEW	-0-	-0-	16	22	49	27	13	126	253	5,217	39.60
LATTINGTOWN	-0-	-0-	-0-	-0-	7	4	1	27	39	2,013	20.51
LAUREL HOLLOW	-0-	-0-	-0-	-0-	1	11	3	28	43	1,663	6.97
LAWRENCE	-0-	-0-	12	8	30	65	22	225	362	6,166	21.56
LEVITTOWN	1	1	14	71	268	181	107	1,790	2,433	55,280	31.55
LIDO/PT. LOOKOUT	1	-0-	2	13	24	26	3	125	194	4,909	26.55
LOCUST VALLEY	-0-	-0-	1	8	35	11	8	108	171	3,461	22.35

\*UNAUTHORIZED USE OF MOTOR VEHICLE

\*\*CLEARANCE RATE PERCENT

TABLE IX  
1987 REPORTED INCIDENCE BY SELECTED CRIME  
BY COMMUNITIES OF OCCURRENCE

COMMUNITY	HOMICIDE	RAPE	ROBBERY	ASSAULT	BURGLARY	LARCENY	* UNAUTH. USE.	OTHER	TOTAL	POP.	** % CLEAR.
LONG BEACH	1	5	45	28	343	764	144	1,791	3,121	34,995	26.08
LYNBROOK	-0-	2	11	24	127	285	69	416	934	19,615	18.30
MALVERNE	1	-0-	3	3	48	102	15	86	258	10,161	21.31
MALVERNE PARK	-0-	-0-	2	-0-	1	3	1	14	21	-	28.57
MANHASSET	-0-	-0-	14	13	59	193	33	533	845	8,518	24.15
MANORHAVEN	-0-	1	-0-	6	6	30	3	87	133	5,792	19.23
MASSAPEQUA	1	-0-	21	51	183	170	69	1,160	1,655	23,659	26.12
MASSAPEQUA PARK	-0-	1	3	10	66	62	14	419	575	19,304	23.37
MERRICK	-0-	1	27	29	138	156	43	908	1,302	23,781	20.66
MILL NECK	-0-	-0-	-0-	2	4	10	1	21	38	1,026	5.26
MINEOLA	-0-	5	14	43	123	163	46	781	1,175	20,345	26.39
MUNSEY PARK	-0-	-0-	-0-	-0-	20	17	3	41	81	2,731	13.75
NEW CASSEL	3	6	25	70	99	39	25	427	694	10,469	62.02
NEW HYDE PARK	-0-	-0-	25	23	82	210	70	859	1,269	9,484	21.75
NORTH BALDWIN	-0-	-0-	1	-0-	1	2	-0-	4	8	-	12.50
NORTH BELLMORE	1	-0-	8	26	98	57	25	509	724	20,017	21.58
NORTH HILLS	-0-	-0-	1	1	18	25	6	153	204	2,859	40.10
NORTH LAWRENCE	-0-	-0-	7	15	25	62	28	254	391	-	40.72
N. LONG BEACH	1	1	4	16	24	42	10	239	337	-	42.98
NORTH LYNBROOK	-0-	-0-	-0-	4	3	5	-0-	30	42	-	45.23
N. MASSAPEQUA	-0-	1	2	16	155	81	36	512	803	20,955	20.91
NORTH MERRICK	-0-	-0-	3	13	81	40	17	348	502	12,487	17.80
N. NEW HYDE PARK	-0-	-0-	18	4	55	163	45	349	634	14,548	14.87
NORTH SEAFORD	-0-	-0-	1	2	13	7	3	45	71	-	23.94
N. VALLEY STREAM	-0-	1	12	5	55	77	36	186	372	14,452	16.26
N. WANTAGH	-0-	-0-	-0-	-0-	7	9	5	67	88	13,077	12.79
N. WOODMERE	-0-	-0-	3	5	25	51	23	144	251	-	19.84
OCEANSIDE	1	2	18	44	168	195	62	1,121	1,611	33,470	31.37

\*UNAUTHORIZED USE OF MOTOR VEHICLE

\*\*CLEARANCE RATE PERCENTAGE

TABLE IX  
1987 REPORTED INCIDENCE BY SELECTED CRIME  
BY COMMUNITIES OF OCCURRENCE

COMMUNITY	HOMICIDE	RAPE	ROBBERY	ASSAULT	BURGLARY	LARCENY	* UNAUTH. USE.	OTHER	TOTAL	POP.	** % CLEAR.
OLD BETHPAGE	-0-	1	1	6	44	26	3	131	212	6,336	17.14
OLD BROOKVILLE/ BROOKVILLE/UPPER BROOKVILLE	2	-0-	3	14	32	142	20	146	359	6,812	26.18
OLD WESTBURY	-0-	-0-	2	5	22	85	1	64	179	3,585	24.02
OYSTER BAY	-0-	3	4	11	48	30	8	213	317	7,467	27.47
OYSTER BAY COVE	-0-	-0-	-0-	-0-	5	8	-0-	2	15	2,292	33.33
PLAINEDGE	-0-	-0-	-0-	2	9	-0-	-0-	24	35	9,396	37.14
PLAINVIEW	-0-	1	9	13	227	161	64	961	1,436	27,572	17.99
PLANDOME	-0-	-0-	-0-	-0-	8	6	1	13	28	1,469	11.11
PLANDOME HEIGHTS	-0-	-0-	-0-	-0-	1	1	1	9	12	956	25.00
PLANDOME MANOR	-0-	-0-	-0-	-0-	3	1	-0-	13	17	924	37.50
PORT WASHINGTON <sup>1</sup>	-0-	-0-	6	9	67	435	44	1,240	1,801	18,879	43.30
ROCKVILLE CENTRE	2	1	33	12	142	556	103	538	1,387	24,997	22.85
ROOSEVELT	4	7	68	133	220	82	76	912	1,502	14,578	50.94
ROSLYN	-0-	-0-	-0-	4	38	42	12	150	246	2,253	22.63
ROSLYN ESTATES	-0-	-0-	-0-	-0-	6	10	4	34	54	1,235	9.61
ROSLYN HARBOR	-0-	-0-	-0-	2	3	4	1	18	28	1,148	32.14
ROSLYN HEIGHTS	-0-	-0-	12	8	78	89	19	306	512	6,288	22.68
RUSSELL GARDENS	-0-	-0-	-0-	-0-	7	5	-0-	11	23	1,343	4.76
SADDLE ROCK	-0-	-0-	-0-	1	10	4	1	20	36	954	41.66
SANDS POINT	1	-0-	-0-	1	4	23	1	13	43	2,730	25.58
SEA CLIFF	1	-0-	3	4	33	11	1	99	152	5,385	21.08
SEAFORD	-0-	3	7	12	93	98	26	618	857	15,898	28.23
SEARINGTOWN	-0-	1	4	-0-	33	16	6	90	150	5,167	14.66
S. FARMINGDALE	-0-	-0-	5	10	77	23	5	242	362	15,706	19.72
S. FLORAL PARK	-0-	1	-0-	5	5	2	3	19	35	1,647	31.42
S. HEMPSTEAD	-0-	-0-	4	4	29	13	2	89	141	3,207	11.42
S. VALLEY STREAM	-0-	-0-	1	-0-	14	23	9	31	78	5,200	10.25

\* UNAUTHORIZED USE OF MOTOR VEHICLE

1- Includes Baxter Estates, Port Washington North, North East and North West

\*\* CLEARANCE RATE PERCENTAGE

TABLE IX  
1987 REPORTED INCIDENCE BY SELECTED CRIME  
BY COMMUNITIES OF OCCURRENCE

COMMUNITY	HOMICIDE	RAPE	ROBBERY	ASSAULT	BURGLARY	LARCENY	* UNAUTH. USE.	OTHER	TOTAL	POP.	** % CLEAR.
S. WESTBURY <sup>2</sup>	-0-	-0-	-0-	-0-	-0-	-0-	-0-	-0-	-0-	9,435	-0-
STEWART MANOR	-0-	-0-	-0-	1	14	2	-0-	42	59	2,477	15.25
SYOSSET	-0-	-0-	6	20	176	143	44	669	1,058	10,403	19.12
THOMASTON	-0-	-0-	1	1	7	18	5	46	78	2,642	18.18
UNIONDALE	1	4	67	54	169	120	58	770	1,243	19,448	32.71
VALLEY STREAM	1	1	54	50	241	364	174	1,345	2,230	34,670	23.83
WANTAGH	-0-	1	15	32	142	130	42	848	1,210	20,354	21.22
W. FARMINGDALE	-0-	-0-	-0-	-0-	1	-0-	-0-	3	4	-	25.00
WEST HEMPSTEAD	-0-	5	31	34	134	143	55	673	1,075	17,994	27.24
WESTBURY	-0-	6	25	45	237	264	101	1,039	1,717	13,775	25.64
WILLISTON PARK	-0-	1	6	7	32	26	11	219	302	7,817	29.76
WOODBURY	-0-	-0-	3	8	30	116	24	332	513	7,718	19.10
WOODMERE	-0-	-0-	7	4	45	86	21	311	474	16,017	14.64
WOODSBURGH	-0-	-0-	-0-	-0-	4	5	1	15	25	849	20.20

\* UNAUTHORIZED USE OF MOTOR VEHICLE

\*\* CLEARANCE RATE PERCENTAGE

2- For Reporting purposes NCPD includes any incidents of crime in the Community of Westbury.

TABLE IX  
1987 REPORTED INCIDENCE BY SELECTED CRIME  
BY OTHER AREAS OF OCCURRENCE

COMMUNITY	HOMICIDE	RAPE	ROBBERY	ASSAULT	BURGLARY	LARCENY	* UNAUTH. USE.	OTHER	TOTAL	POP.	** % CLEAR.
BELMONT RACE TRACK	-0-	-0-	3	8	2	6	7	64	90	-0-	77.52
EISENHOWER PARK	-0-	-0-	2	1	-0-	3	-0-	14	20	-0-	27.77
GREEN ACRES SHOPPING CENTER	1	-0-	18	12	7	293	182	778	1,291	-0-	46.09
MID ISLAND SHOPPING CENTER	-0-	-0-	1	6	5	58	29	185	284	-0-	27.11
MITCHEL FIELD	-0-	-0-	-0-	-0-	3	3	-0-	13	19	-0-	10.52
NASSAU COLISEUM	-0-	-0-	1	10	4	14	2	48	79	-0-	33.33
ROOSEVELT FIELD	-0-	-0-	20	16	28	399	137	733	1,333	-0-	33.73
ROOSEVELT RACEWAY	-0-	-0-	-0-	1	2	27	3	12	45	-0-	11.11
SEARS SHOP CTR.	-0-	-0-	1	-0-	2	16	1	46	66	-0-	38.46
SUNRISE CINEMA	-0-	-0-	2	6	-0-	53	41	116	218	-0-	46.04
SUNRISE MALL, MASS.	1	-0-	8	25	9	205	81	599	928	-0-	47.01

\*UNAUTHORIZED USE OF MOTOR VEHICLE

\*\*CLEARANCE RATE PERCENT

### TOTAL CRIMINAL INCIDENTS

While there are some areas that have offense levels that are much higher than the County norm, generally, crime in Nassau County remains a dispersed phenomenon. Indicative of this is the fact that the communities with the highest concentrations of population consistently have the highest number of reported (see TABLE XA) crimes. The increase in the number of criminal incidents in Nassau County for 1988 is also reflected in increases in the reported incidents in the majority of the ten communities with the greatest number of crimes.

TABLE X-A

NUMBER OF INCIDENTS\*

1988 COMMUNITY RANKINGS

<u>COMMUNITY</u>	<u>1988</u>	<u>1987</u>	<u>1986</u>	<u>1985</u>	<u>1984</u>
1. HEMPSTEAD <sup>1</sup>	5,898	5,385	5,704	5,156	5,136
2. LONG BEACH <sup>1</sup>	2,872	3,121	3,169	3,073	3,204
3. FREEPORT <sup>1</sup>	2,528	2,925	2,631	2,693	2,527
4. LEVITTOWN	2,407	2,434	2,120	2,177	2,177
5. HICKSVILLE	2,288	2,149	2,004	1,965	2,106
6. ELMONT	2,263	2,118	2,140	2,152	2,002
7. EAST MEADOW	2,181	2,273	2,305	2,278	2,122
8. VALLEY STREAM	2,114	2,230	2,019	2,188	1,899
9. GLEN COVE <sup>1</sup>	1,894	1,687	1,933	1,963	1,814
10. ROOSEVELT	1,861	1,502	1,415	1,510	1,329

Of the top ten communities showing the highest number of incidents for 1988 eight of the ten appeared on this list for 1987.

\*COMMUNITIES WITH LESS THAN 5,000 RESIDENTS NOT REPRESENTED

<sup>1</sup> SERVED BY INDEPENDENT POLICE DEPARTMENT

TABLE X-B

INCIDENTS PER 1,000 RESIDENTS\*

1988 COMMUNITY RANKINGS

<u>COMMUNITY</u>	<u>1988</u>	<u>1987</u>	<u>1986</u>	<u>1985</u>	<u>1984</u>
1. HEMPSTEAD	142.6	130.1	138.6	124.4	122.9
2. CARLE PLACE	135.0	131.7	129.9	145.1	121.9
3. NEW HYDE PARK	133.4	133.8	123.7	110.0	102.3
4. WESTBURY	128.0	124.6	138.2	132.0	123.4
5. ROOSEVELT	126.2	103.1	98.0	105.5	92.5
6. CEDARHURST	108.5	90.2	106.7	102.5	111.4
7. SYOSSET	101.1	101.8	113.5	118.9	118.7
8. MANHASSET	97.3	99.2	123.1	124.9	130.0
9. FARMINGDALE	91.3	96.9	76.3	85.1	82.6
10. NEW CASSEL	91.3	66.6	76.6	59.2	63.2

Of the top ten communities showing the highest number of crime incidents per 1,000 residents nine of the ten appeared on this list for 1987.

\* COMMUNITIES WITH LESS THAN 5,000 RESIDENTS NOT REPRESENTED  
1 SERVED BY INDEPENDENT POLICE DEPARTMENT



TABLE X-C

ROBBERIES AND BURGLARIES PER 1,000 RESIDENTS\*

1988 COMMUNITY RANKINGS

<u>COMMUNITY</u>	<u>1988</u>	<u>1987</u>	<u>1986</u>	<u>1985</u>	<u>1984</u>
1. HEMPSTEAD <sup>1</sup>	22.2	24.7	24.2	25.9	21.3
2. WESTBURY	20.6	19.0	21.1	19.9	20.4
3. ROOSEVELT	18.8	19.8	21.7	28.9	29.2
4. CARLE PLACE	17.7	12.6	10.5	15.0	10.7
5. CEDARHURST	16.0	12.6	12.5	9.3	12.0
6. NEW HYDE PARK	14.9	11.3	13.5	11.9	11.3
7. FREEPORT <sup>1</sup>	14.0	16.0	16.6	19.8	20.5
8. SYOSSET	13.9	17.5	19.7	17.2	16.0
9. GREAT NECK	13.6	12.4	10.6	9.9	14.3
10. ROSLYN HEIGHTS	13.4	14.3	17.3	12.3	14.3

Of the ten communities with the greatest numbers of robberies and burglaries per 1,000 residents eight of the ten appeared on the list for 1987.

\* COMMUNITIES WITH LESS THAN 5,000 RESIDENTS NOT REPRESENTED

<sup>1</sup> SERVED BY INDEPENDENT POLICE DEPARTMENT

SECTION - V

ARRESTS

The total number of persons arrested in Nassau County, 23,883 in 1988 represents a increase of 8.4% from the 1987 total. Part I Crimes accounted for 27.8% of the total arrests for 1988. Of the 6,644 Part I arrests, 64.3% were for larceny, 12.4% were for assault and 12.3% for burglary.

TABLE - XI  
TOTAL ARREST BY CRIME TYPE 1979-1988

PART I

CRIME	1979	1980	1981	1982	1983	1984	1985	1986	1987	1988	NCPD 1988
*HOMICIDE	40	49	58	53	48	49	39	51	56	43	27
RAPE	38	41	48	32	41	42	40	39	57	40	21
ROBBERY	500	538	541	601	606	411	497	454	499	447	274
AGGRAVATED ASSAULT	517	555	545	646	593	688	690	756	793	823	447
BURGLARY	2,087	2,116	1,768	1,400	1,238	938	886	809	797	820	544
LARCENY	4,019	4,107	3,865	4,089	3,563	3,577	3,695	3,741	4,268	4,275	3,409
AUTO THEFT	<u>289</u>	<u>253</u>	<u>245</u>	<u>201</u>	<u>171</u>	<u>162</u>	<u>174</u>	<u>252</u>	<u>204</u>	<u>196</u>	<u>144</u>
SUB-TOTAL	7,490	7,659	7,070	7,022	6,260	5,867	6,021	6,102	6,674	6,644	4,866

\* Includes Murder, Negligent and Non-Negligent Manslaughter

TABLE - XI  
TOTAL ARREST BY CRIME TYPE 1979-1988

PART II

CRIME	1979	1980	1981	1982	1983	1984
ARSON	64	65	64	58	64	51
KIDNAPPING	8	0	0	8	1	3
DRUG OFFENSES	1,489	1,854	1,906	1,811	1,581	1,784
DANGEROUS WEAPONS	374	405	421	435	460	365
BRIBERY	2	5	3	9	3	6
SEX OFFENSES	170	244	183	143	157	172
EXTORTION	0	0	3	0	1	3
FORGERY & COUNTERFEITING	222	222	228	308	242	240
PROSTITUTION	99	70	73	123	125	213
STOLEN PROPERTY	645	654	632	640	585	563
COERCION	2	1	1	6	1	1
CRIMINAL MISCHIEF	1,037	927	888	831	720	925
FRAUD	171	161	173	153	164	168
GAMBLING	164	99	65	63	49	45
PUBLIC DISORDER	211	32	37	9	10	22
EMBEZZLEMENT	0	0	1	0	0	6
SIMPLE ASSAULT	868	973	800	879	876	1,297
FAMILY OFFENSES	89	63	60	88	142	75
D.W.I	2,636	3,495	4,082	5,150	4,919	5,869
UNAUTHORIZED VEHICLE USE	108	77	163	144	93	108
BURGLAR'S TOOLS	6	7	39	19	13	72
LIQUOR LAW VIOLATIONS	26	41	32	36	74	31
DISORDERLY CONDUCT	873	709	596	660	658	777
PUBLIC NARCOTIC INTOX.	1	7	1	0	1	1
LOITERING	17	26	89	116	263	327
ALL OTHER	<u>3,352</u>	<u>4,138</u>	<u>3,541</u>	<u>3,380</u>	<u>3,473</u>	<u>2,147</u>
TOTAL	12,634	14,275	14,081	15,069	14,675	15,271

TABLE XI  
TOTAL ARREST BY CRIME TYPE 1979-1988

PART II

CRIME	1985	1986	1987	1988	NCPD ONLY 1988
ARSON	39	18	34	32	25
KIDNAPPING	12	9	13	5	3
DRUG OFFENSES	1,772	2,150	2,315	3,059	1,440
DANGEROUS WEAPONS	384	422	443	496	317
BRIBERY	12	5	11	22	16
SEX OFFENSES	220	182	155	153	107
EXTORTION	4	9	19	4	3
FORGERY & COUNTERFEITING	286	288	290	296	219
PROSTITUTION	230	646	668	499	51
STOLEN PROPERTY	590	617	758	1,033	706
COERCION	4	2	5	4	1
CRIMINAL MISCHIEF	1,097	899	923	834	503
FRAUD	205	173	201	281	228
GAMBLING	40	49	66	89	61
PUBLIC DISORDER	88	45	90	60	13
EMBEZZLEMENT	6	4	2	3	1
SIMPLE ASSAULT	1,422	1,375	1,172	1,325	970
FAMILY OFFENSES	90	99	84	81	2
D.W.I.	5,671	4,988	4,788	5,262	3,392
UNAUTHORIZED VEH. USE	122	99	125	98	25
BURGLAR'S TOOLS	96	43	72	35	25
LIQUOR LAW VIOLATIONS	71	24	54	37	-0-
DISORDERLY CONDUCT	688	650	632	699	138
PUBLIC NARCOTIC INTOX.	0	9	14	6	1
LOITERING	435	337	63	45	-0-
ALL OTHER	<u>2,373</u>	<u>2,462</u>	<u>2,355</u>	<u>2,781</u>	<u>1,263</u>
TOTAL	15,957	15,604	15,352	17,239	9,510

AN ANALYSIS OF PART II ARRESTS 1979-1988

As previously mentioned in this report the number of Part II incidents decreased .7% from 1979-1988. In contrast the number of Part II arrests increased 36.4% in the corresponding period.

This significant increase can be attributed to increases of arrests for the following crimes:

Simple Assault	52.6%
DWI	99.6%
Drug Offenses	105.4%

CRIME  
TOTAL ARRESTS PART I 1979-1988

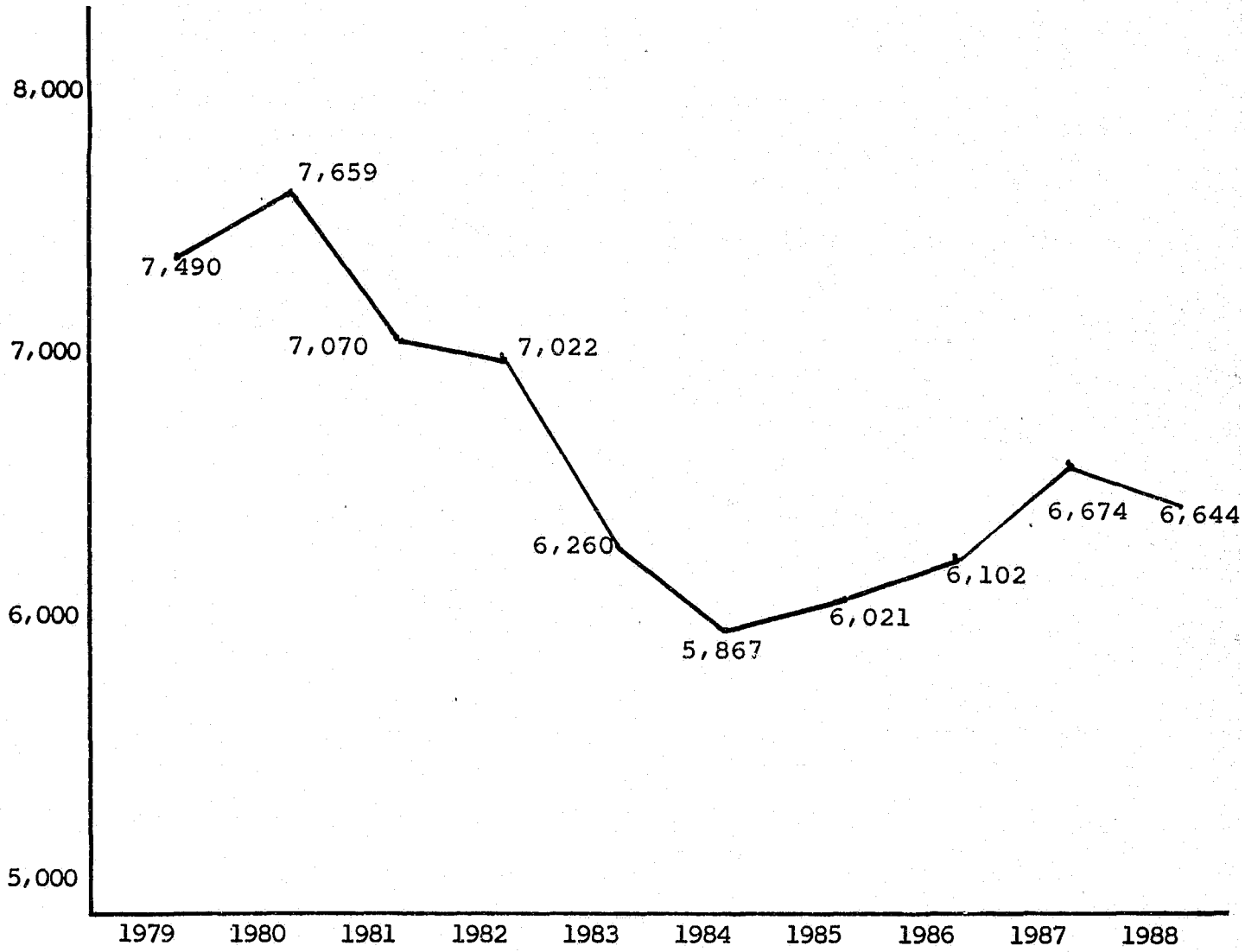

CRIME  
TOTAL ARRESTS PART II 1979-1988

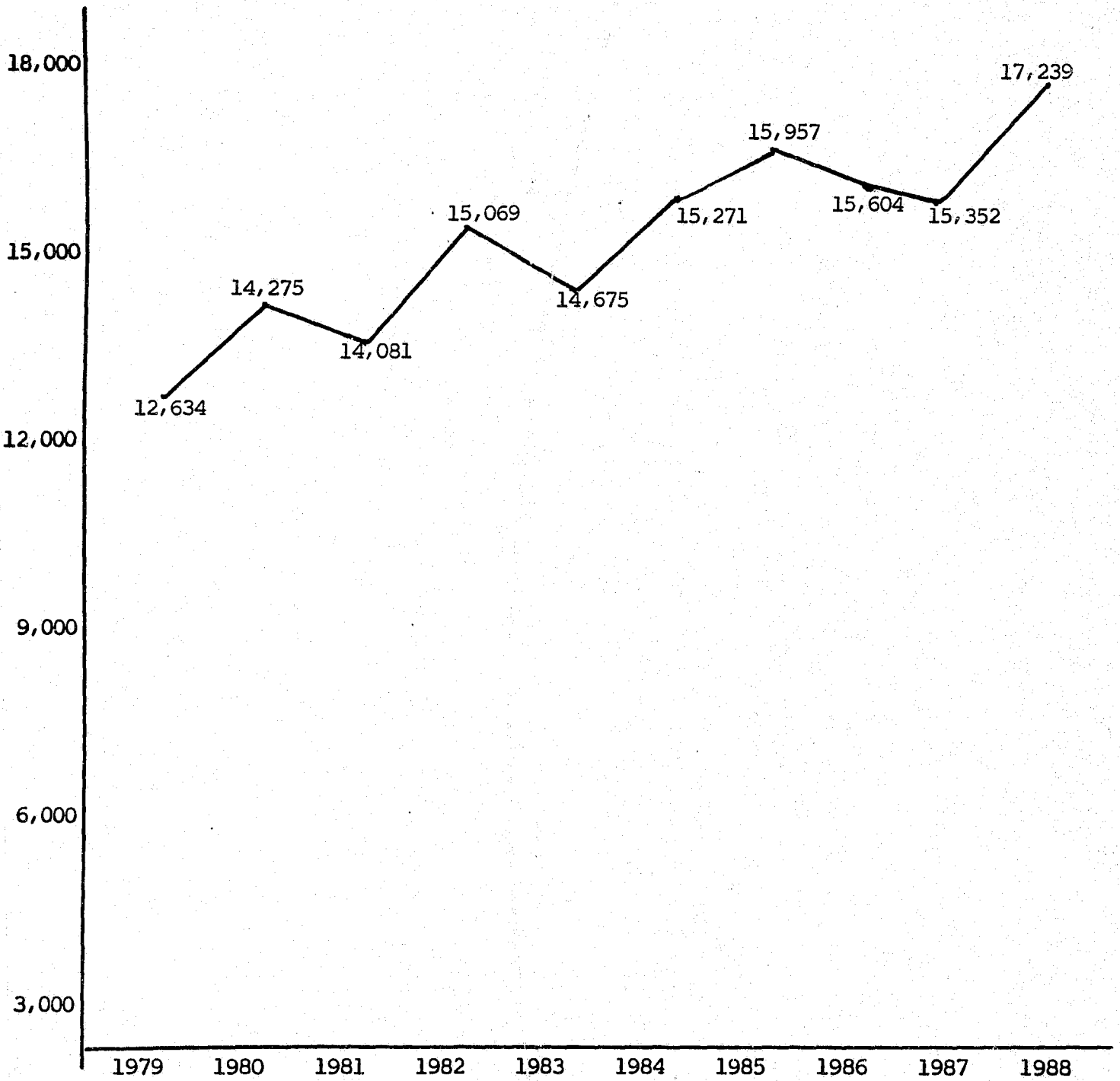

CRIME  
TOTAL ARRESTS PART I & PART II 1979-1988

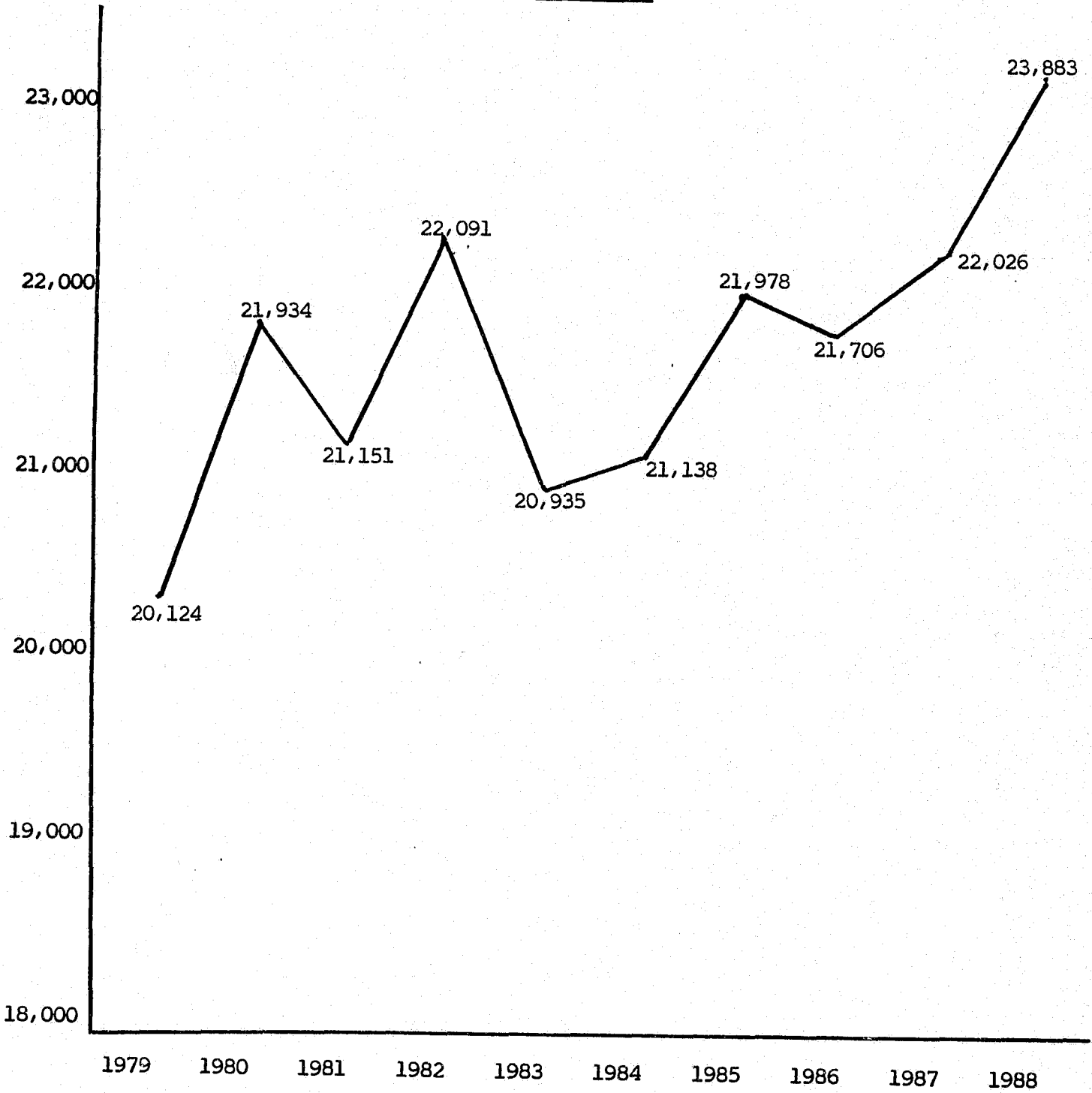



## ANALYSIS OF ARRESTEES

### AN ANALYSIS OF THE AGE OF ARRESTEES 1979-1988

A review of TABLE XI-A indicates that the number of arrests have increased by 18.7% from 1979 to 1988. We also note that the age group with the greatest increase in arrests between 1979 to 1988 is the 30-39 age group, 2,633 in 1979, 5,197 in 1988, a 97% increase.

In addition, the 25-29 age group showed an increase of 97.9% in arrests when comparing 1979 (2,435) to 1988 (4,820).

### AN ANALYSIS OF JUVENILE ARRESTEES\* FOR PART I OFFENSES 1979-1988

A review of the ten year trend (1979-1988) indicates that the percentage of Juveniles arrested for Part I crimes has decreased from 17.2% in 1979 to 8.3% in 1988.

### AN ANALYSIS OF THE SEX, RACE AND ETHNIC CHARACTERISTICS OF ARRESTEES 1979-1988

A review of the characteristics of arrestees indicates that male arrests increased by 16.2% and female arrests increased 32.6% when comparing 1979 to 1988. The percentage of white arrestees has remained constant while black arrestees have increased 46.9% from 1979 to 1988.

\*Less than 16 years of age

AGE OF ARRESTEES

The data that follows provides demographic information concerning the age of arrestees.

TABLE-XI-A

<u>AGE GROUP</u>	<u>1979</u>	<u>1980</u>	<u>1981</u>	<u>1982</u>	<u>1983</u>	<u>1984</u>	<u>1985</u>	<u>1986</u>	<u>1987</u>	<u>1988</u>	<u>% Change 1987-1988</u>
12 & under	298	274	246	192	177	169	164	164	176	174	(1.1)
13 - 15	1,848	1,761	1,547	1,358	1,126	1,106	1,231	1,136	1,019	965	(5.3)
16 - 19	6,309	6,165	5,443	5,173	4,806	4,285	4,297	4,247	4,239	4,232	(.2)
20 - 24	4,337	5,118	5,134	5,410	5,246	5,284	5,394	5,343	5,250	5,527	5.3
25 - 29	2,435	2,949	2,949	3,374	3,267	3,678	3,890	3,987	3,822	4,820	26.1
30 - 39	2,633	3,107	3,200	3,688	3,583	3,830	4,114	4,193	4,743	5,197	9.6
40 - 49	1,247	1,421	1,493	1,611	1,548	1,647	1,734	1,610	1,794	1,945	8.4
50 - 59	742	798	810	882	782	770	798	681	666	690	3.6
60 & over	<u>275</u>	<u>341</u>	<u>329</u>	<u>403</u>	<u>400</u>	<u>369</u>	<u>356</u>	<u>345</u>	<u>352</u>	<u>333</u>	<u>(5.4)</u>
TOTAL	20,124	21,934	21,151	22,091	20,935	21,138	21,978	21,706	22,061	23,883	8.3

TABLE XI-B

AGE OF PERSONS ARRESTED BY CRIME 1988

	<u># OF PERSONS UNDER 25</u>	<u># OF PERSONS 25 &amp; OVER</u>	<u>TOTAL</u>	<u>% UNDER 25</u>	<u>% OVER 25</u>
BURGLARY	512	308	820	62.4	37.6
ROBBERY	275	172	447	61.5	38.5
LARCENY	2,124	2,151	4,275	49.7	50.3
ASSAULT	387	436	823	47.0	53.0

An analysis of TABEL XI-B indicates that 51.8% of those arrested for the above Part I crimes are under the age of 25. Those under the age of 25 account for 62.4% of all arrests for Burglary and 61.5% of all arrests for Robbery.

TABLE XI-B-1

AGE OF PERSONS ARRESTED BY CRIME 1982-1988\*

	<u>TOTAL ARRESTS 1982</u>	<u>% UNDER 25</u>	<u>TOTAL ARRESTS 1983</u>	<u>% UNDER 25</u>	<u>TOTAL ARRESTS 1984</u>	<u>% UNDER 25</u>	<u>TOTAL ARRESTS 1985</u>	<u>% UNDER 25</u>	<u>TOTAL ARRESTS 1986</u>	<u>% UNDER 25</u>	<u>TOTAL ARRESTS 1987</u>	<u>% UNDER 25</u>	<u>TOTAL ARRESTS 1988</u>	<u>% UNDER 25</u>
BURGLARY	1,400	80.7	1,238	77.4	938	75.5	886	75.1	809	70.5	797	68.1	820	62.4
ROBBERY	601	78.2	606	77.3	411	74.9	497	73.8	454	66.7	499	67.3	447	61.5
LARCENY	4,089	58.3	3,563	57.7	3,577	57.7	3,695	57.1	3,741	56.9	4,268	51.7	4,275	49.7
ASSAULT	646	55.9	593	59.8	688	53.5	690	56.8	756	55	793	52.1	823	47.0

\*Prior years not available

TABLE XI-C

JUVENILE ARRESTEES FOR PART I CRIME AS COMPARED TO TOTAL PART I FOR ARRESTS\*

	<u>1979</u>	<u>1980</u>	<u>1981</u>	<u>1982</u>	<u>1983</u>	<u>1984</u>	<u>1985</u>	<u>1986</u>	<u>1987</u>	<u>1988</u>
LESS THAN 16 YEARS OF AGE	17.2%	16.2%	14.5%	12.8%	18.0%	17.5%	10.8%	10.6%	7.9%	8.3%

The percentage of those arrested for Part I crimes who are under the age of 16 years of age has increased from 7.9% in 1987 to 8.3% in 1988.

\*See TABLE XI-A

ARRESTEE CHARACTERISTICS

Analysis of arrestee characteristics indicates that male arrests showed an increase of 9.2% from 1987 to 1988 while female arrests increased 3.8% from 1987 to 1988. During the period of 1987 to 1988 white arrestees increased 9.2% and black arrestees increased 6.6%

TABLE-XII

CHARACTERISTICS

SEX	1979	1980	1981	1982	1983	1984	1985	1986	1987	1988
MALE	17,102	18,826	18,054	18,613	17,766	17,916	18,417	18,205	18,202	19,877
FEMALE	3,022	3,108	3,097	3,478	3,169	3,222	3,561	3,501	3,859	4,006
RACE	1979	1980	1981	1982	1983	1984	1985	1986*	1987*	1988*
WHITE	14,232	15,061	14,303	14,976	13,465	13,166	13,631	13,234	12,742	13,911
BLACK	5,868	6,810	6,807	7,053	7,384	6,277	6,750	7,436	8,085	8,619
INDIAN	9	1	4	9	31	9	15	35	11	31
ASIAN	15	62	37	53	55	49	64	86	89	153
HISPANIC						1,280	1,518	**	**	**
OTHER						357				
% OF	1979	1980	1981	1982	1983	1984	1985	1986	1987	1988
WHITE	70.7	68.7	67.6	67.8	64.3	62.3	62.0	63.6	60.9	61.2
BLACK	29.2	31.0	32.2	31.9	35.3	29.7	30.7	35.8	38.6	37.9

\*Race total for 1986-1988 does not equal total arrest figures due to the fact that DWI Traffic Citations do not include race category.

\*\*Hispanic, as a classification is no longer a category for reporting purposes.

Following is a table showing the rank order of Nassau County communities in terms of the number of crimes per 1,000 residents per community and the number of Impact Crimes (ROBBERY & BURGLARY) committed per 1,000 residents per community\*.

APPENDIX B 1988

<u>COMMUNITY</u>	<u># OF CRIMES</u>	<u>RANK</u>	<u>CRIMES PER 1,000</u>	<u>RANK</u>	<u>IMPACT CRIMES PER 1,000</u>	<u>RANK</u>
ALBERTSON	235	68**	43.6	60	4.1	56**
ATLANTIC BEACH	204	73	48.2	54	5.9	43
BALDWIN	1,504	14	47.9	55	5.5	46**
BALDWIN HARBOR	17	115	-0-	-0-	-0-	-0-
BAY PARK	34	104	14.8	109	1.3	76
BAYVILLE	245	66	30.3	84	5.8	44**
BELLEROSE	114	82**	93.0	12	22.8	1
BELLEROSE TERRACE	129	80	66.9	26	7.3	34**
BELLMORE	894	30	50.7	53	5.7	45
BETHPAGE	1,148	22	69.2	24	8.3	30
CARLE PLACE	708	38	135.0	3	17.7	6
CEDARHURST	638	40	108.5	7	16.0	8
CENTRE ISLAND	16	116	39.4	66	-0-	-0-
COVE NECK	7	119	20.6	99	2.9	66**
E. GARDEN CITY	446	53	93.2	11	7.3	34**
EAST HEMPSTEAD	40	100	-0-	-0-	-0-	-0-
EAST HILLS	246	65	35.9	72	8.0	31
E. MASSAPEQUA	350	59	26.2	88	2.8	67**
EAST MEADOW	2,181	7	54.2	38	6.0	42**
E. NORWICH	84	87	31.0	83	5.2	47**
EAST ROCKAWAY	357	58	33.9	76**	3.0	65**
EAST WILLISTON	46	95**	17.6	104	2.3	70
ELMONT	2,263	6	82.9	16	10.6	20
FARMINGDALE	736	35	91.3	13	10.4	22
FLORAL PARK	485	49	29.7	86	4.8	50**
FLORAL PARK CENTER	48	93	-0-	-0-	-0-	-0-
FLOWER HILL	152	78	33.2	79	7.2	35**
FRANKLIN SQUARE	1,046	27	36.1	71**	3.4	62
FREEPORT	2,528	3	65.4	7	14.0	11
GARDEN CITY	1,044	28	47.5	56	6.8	39**
GARDEN CITY PARK	483	50	62.3	31	6.8	39**
GARDEN CITY SOUTH	87	86	21.6	98	1.2	77**
GLEN COVE	1,894	9	72.4	22	6.2	40**
GLEN HEAD	235	68**	51.4	52	10.0	24
GLENWOOD LANDING	26	108	7.2	114	1.4	75
GREAT NECK	1,142	23	73.9	21	13.6	13
GREAT NECK ESTATES	101	84	36.2	70	6.8	39**
GREAT NECK PLAZA	496	46	81.6	17	11.5	16
GREENVALE	193	74	53.1	40**	5.8	44**
HARBOR ISLE	22	111**	-0-	-0-	-0-	-0-
HEMPSTEAD	5,898	1	142.6	2	22.2	2

\* Communities are ranked in numerical order regardless of population  
 \*\* Indicates a tie with another Community.

APPENDIX B 1988

<u>COMMUNITY</u>	<u># OF CRIMES</u>	<u>RANK</u>	<u>CRIMES PER 1,000</u>	<u>RANK</u>	<u>IMPACT CRIMES PER 1,000</u>	<u>RANK</u>
HERRICKS	59	90	7.6	113	.4	80**
HEWLETT	495	47	69.5	23**	6.2	40**
HEWLETT BAY PARK	22	111**	46.9	57	2.1	71**
HEWLETT HARBOR	39	101	31.6	82	1.6	74**
HEWLETT NECK	9	117	20.2	100	-0-	-0-
HICKSVILLE	2,288	5	54.5	37**	6.1	41**
INWOOD	653	39	69.5	23**	12.2	15
ISLAND PARK	241	67	25.3	90	3.1	64
JERICO	879	31	64.7	30	6.9	38
KENSINGTON	36	104	31.9	81	1.8	73**
KINGS POINT	114	82**	21.7	97	4.8	50**
LAKE SUCCESS	473	51	215.2	1	18.2	5
LAKEVIEW	273	63	51.8	41	11.4	17
LATTINGTOWN	45	96	22.0	96	2.0	72
LAUREL HOLLOW	42	98	25.2	91**	4.8	50**
LAWRENCE	497	45	80.5	18	8.4	29
LEVITTOWN	2,047	4	43.5	61	4.1	56**
LIDO/POINT LOOKOUT	219	71	44.5	59**	4.3	54**
LOCUST VALLEY	190	75	54.9	36	16.2	7
LONG BEACH	2,872	2	79.6	19**	7.9	32
LYNBROOK	835	33	42.6	63	5.8	44**
MALVERNE	300	61	33.9	76**	3.8	59
MALVERNE PARK	21	112**	-0-	-0-	-0-	-0-
MANHASSET	828	34	97.3	10	10.7	19
MANHASSET HILLS	37	103	-0-	-0-	-0-	-0-
MANORHAVEN	159	77	27.4	87	1.6	74**
MASSAPEQUA	1,533	13	64.8	29	7.2	35**
MASSAPEQUA PARK	569	41	29.5	85	3.5	61**
MERRICK	1,061	25	44.5	59**	5.1	48
MILL NECK	23	110	22.6	95	2.9	66**
MINEOLA	1,170	20	57.5	35	8.6	28
MUNSEY PARK	54	92	19.8	101	4.8	50**
NEW CASSEL	902	29	84.4	14	9.1	26
NEW HYDE PARK	1,269	18	133.4	4	14.9	10
NORTH BALDWIN	8	118	-0-	-0-	-0-	-0-
N. BELLMORE	724	37	36.1	71**	4.7	51
NORTH HILLS	207	22	67.6	25	2.9	66**
N. LAWRENCE	471	52	-0-	-0-	-0-	-0-
N. LONG BEACH	346	60	-0-	-0-	-0-	-0-
N. LYNBROCK	20	113	-0-	-0-	-0-	-0-
N. MASSAPEQUA	732	36	34.9	74	3.9	58
N. MERRICK	494	48	39.6	65	6.0	42**
N. NEW HYDE PARK	529	44**	36.4	69	3.5	61
N. SEAFORD	46	95**	-0-	-0-	-0-	-0-
N. VALLEY STREAM	367	57	25.7	89	3.2	63
N. WANTAGH	64	89	4.9	115	.6	79
N. WOODMERE	257	64	-0-	-0-	-0-	-0-
OCEANSIDE	1,456	15	43.3	62	4.4	53
OLD BETHPAGE	150	79	23.6	94	5.2	47**
OLD BROOKVILLE/ BROOKVILLE/UPPER BROOKVILLE	555	42	78.1	20	9.6	25

## APPENDIX B 1988

<u>COMMUNITY</u>	<u># OF CRIMES</u>	<u>RANK</u>	<u>CRIMES PER 1,000</u>	<u>RANK</u>	<u>IMPACT CRIMES PER 1,000</u>	<u>RANK</u>
OLD WESTBURY	221	70	61.3	32**	10.8	18
OYSTER BAY	275	62	36.7	68	4.5	52**
OYSTER BAY COVE	30	107	12.9	112	7.3	34**
PLAINEDGE	44	97	4.7	116	.4	80**
PLAINVIEW	1,166	21	41.9	64	6.8	39**
PLANDOME	24	109**	16.4	106	4.1	56**
PLANDOME HEIGHTS	18	114**	18.8	103	10.5	21
PLANDOME MANOR	18	114**	19.3	102	2.1	71**
PORT WASHINGTON	1,567	12	79.6	19**	3.0	65**
ROCKVILLE CENTRE	1,328	16	53.1	40**	7.2	35**
ROOSEVELT	1,861	10	126.2	6	18.8	4
ROSLYN	226	69	99.5	9	15.9	9
ROSLYN ESTATES	57	91	46.1	58	8.9	27
ROSLYN HARBOR	41	99	35.7	73	4.3	54**
ROSLYN HEIGHTS	529	44**	84.2	15	13.4	14
RUSSELL GARDENS	21	112**	15.6	107	4.5	52**
SADDLE ROCK	24	109**	25.2	91**	4.2	55
SANDS POINT	47	94	17.2	105	4.0	57
SEA CLIFF	188	76	34.7	75	7.6	33
SEAFORD	847	32	53.1	40**	5.5	46**
SEARINGTOWN	125	81	24.0	93	5.2	47**
S.E. FARMINGDALE	381	56	24.2	92	2.7	68
S.E. FLORAL PARK	24	109**	14.6	110	1.8	73**
SOUTH HEMPSTEAD	108	83	33.7	77	3.7	60
S.W. VALLEY STREAM	75	88	14.5	111	1.2	78
STEWART MANOR	38	102	15.3	108	2.8	67**
THOSSET	1,048	26	101.1	8	13.9	12
THOMASTON	88	85	33.4	78	10.3	23**
THURMONT	1,273	17	65.2	28	10.3	23**
TRINITY STREAM	2,114	8	61.0	33	7.1	36
TRINITY	1,251	19	61.3	32**	7.0	37
T.W. FARMINGDALE	5	120	-0-	-0-	-0-	-0-
WEST HEMPSTEAD	1,096	24	60.7	34	6.1	41**
WESTBURY	1,776	11	128.0	5	20.6	3
WILLISTON PARK	417	55	53.3	39	2.9	66**
WOODBURY	433	54	54.5	37**	5.0	49
WOODMERE	531	43	33.1	80	2.6	69
WOODSBURGH	32	106	38.4	67	6.0	42**



Following is a table showing the rank order of Nassau County Areas frequented by County residents.

APPENDIX B-1 1988

<u>OTHER AREAS</u>	<u># OF CRIMES</u>	<u>RANK</u>	<u>CRIMES PER 1,000</u>	<u>RANK</u>	<u>IMPACT CRIMES PER 1,000</u>	<u>RANK</u>
BELMONT RACE TRACK	63	8	-0-	-0-	-0-	-0-
EISENHOWER PARK	30	10	-0-	-0-	-0-	-0-
GREEN ACRES*	1,494	1	-0-	-0-	-0-	-0-
MID ISLAND*	247	4	-0-	-0-	-0-	-0-
MITCHEL FIELD	17	11	-0-	-0-	-0-	-0-
NASSAU COLISEUM	139	6	-0-	-0-	-0-	-0-
ROOSEVELT FIELD*	1,167	2	-0-	-0-	-0-	-0-
ROOSEVELT RACEWAY	36	9	-0-	-0-	-0-	-0-
SEARS SHOPPING CENTER	122	7	-0-	-0-	-0-	-0-
SUNRISE CINEMA	148	5	-0-	-0-	-0-	-0-
SUNRISE MALL*	877	3	-0-	-0-	-0-	-0-

\*SHOPPING CENTER

Following is a table showing the rank order of Nassau County communities in terms of the number of crimes per 1,000 residents per community and the number of Impact Crimes (ROBBERY & BURGLARY) committed per 1,000 residents per community\*.

APPENDIX B 1987

<u>COMMUNITY</u>	<u># OF CRIMES</u>	<u>RANK</u>	<u>CRIMES PER 1,000</u>	<u>RANK</u>	<u>IMPACT CRIMES PER 1,000</u>	<u>RANK</u>
ALBERTSON	264	64	49.4	49**	10.3	23**
ATLANTIC BEACH	244	70	58.2	37	10.5	21**
BALDWIN	1,476	15	47.1	53	7.2	35**
BALDWIN HARBOR	20	113	-	-	-	-
BAY PARK	46	100	20	94	1.7	68
BAYVILLE	255	66	31.9	75	5.6	46**
BELLEROSE	91	85	74.3	20	17.2	6
BELLEROSE TERRACE	90	86	46.6	54	4.7	53**
BELLMORE	880	30	50.1	47	5.1	50**
BETHPAGE	1,180	23	71.2	23	9.2	25**
CARLE PLACE	688	38	131.7	4	11.1	19**
CEDARHURST	532	42	90.2	14	12.6	12**
CENTRE ISLAND	6	119	15	101**	-	-
COVE NECK	9	117	26.9	84	-	-
E. GARDEN CITY	530	43	124.9	6	9.9	24
EAST HEMPSTEAD	52	96	-	-	-	-
EAST HILLS	313	61	45.6	55	11.1	19**
E. MASSAPEQUA	331	59	24.8	88	3.4	61
EAST MEADOW	2,273	5	57.1	39	6.1	43
E. NORWICH	110	84	40.7	61	6.7	40**
EAST ROCKAWAY	341	57	32.4	73	3.8	58
EAST WILLISTON	50	97	19.1	96**	2.7	65**
ELMONT	2,118	8	77.9	17	11.2	18
FARMINGDALE	775	35	96.9	12	12.5	13**
FLORAL PARK	525	44	32.2	74	3.9	57**
FLORAL PARK CENTER	60	93	-	-	-	-
FLOWER HILL	171	77**	37.4	68	10.9	20
FRANKLIN SQUARE	982	28	34.3	71	4.4	55
FREEPORT	2,925	3	75.7	19	16.0	8
GARDEN CITY	1,232	21	56	40	7.5	33**
GARDEN CITY PARK	505	47	65.2	29	8.1	29
GARDEN CITY SOUTH	72	91	17.8	98**	2.7	65**
GLEN COVE	1,687	11	65.6	28	7.6	32**
GLEN HEAD	174	76	38.6	64**	7.8	30
GLENWOOD LANDING	29	108	8.1	104	.6	73**
GREAT NECK	1,117	25	72.1	21	12.4	14
GREAT NECK ESTATES	151	79	54	43**	4.6	54**
GREAT NECK PLAZA	425	52	70.5	24	6.6	41**
GREENVALE	228	71	216.	1	15.2	9
HARBOR ISLE	37	105	-	-	-	-
HEMPSTEAD	5,385	1	130.1	5	24.7	1

\*Communities are ranked in numerical order regardless of population.

\*\*Indicates a tie with another Community.

APPENDIX B 1987

<u>COMMUNITY</u>	<u># OF CRIMES</u>	<u>RANK</u>	<u>CRIMES PER 1,000</u>	<u>RANK</u>	<u>IMPACT CRIMES PER 1,000</u>	<u>RANK</u>
HERRICKS	79	89	10.2	103	1.2	71
HEWLETT	477	49	66.9	26	7.6	32**
HEWLETT BAY PARK	36	106**	77.6	18	12.6	11
HEWLETT HARBOR	47	99	37.9	66	1.6	69
HEWLETT NECK	8	118**	17.8	98**	-	-
HICKSVILLE	2,149	7	51.4	46	6.7	40**
INWOOD	545	4	59.3	35	12.6	12**
ISLAND PARK	270	63	28.4	82	2.2	67**
JERICHO	867	31	65.	30	7.6	32**
KENSINGTON	48	98	42.7	59	8.9	26
KINGS POINT	114	83	21.7	92	5.9	44
LAKE SUCCESS	467	51	212.5	2	21.8	2
LAKEVIEW	253	67	48.5	50	12.5	13**
LATTINGTOWN	39	103	19.4	95	3.5	60
LAUREL HOLLOW	43	101**	25.9	85	.6	73**
LAWRENCE	362	55**	58.7	36	6.8	39
LEVITTOWN	2,434	4	44.0	56**	5.1	50**
LIDO/POINT LOOKOUT	193	74	39.3	63	5.3	48**
LOCUST VALLEY	171	77*	49.4	49**	10.4	22
LONG BEACH	3,121	2	89.2	15	11.1	19**
LYNBROOK	934	29	47.6	52	7.0	37**
MALVERNE	258	65	25.4	87	5.0	51**
MALVERNE PARK	21	112	-	-	-	-
MANHASSET	845	33	99.2	11	8.6	27**
MANORHAVEN	133	82	23.0	91**	1.0	72**
MASSAPEQUA	1,665	12	70.0	25	8.6	27**
MASSAPEQUA PARK	575	40	29.8	76	3.6	59
MERRICK	1,303	18	54.8	42	6.9	38
MILL NECK	38	104	37.0	69	3.9	57**
MINEOLA	1,176	24	57.8	38	6.7	40**
MUNSEY PARK	81	88	29.7	77	7.3	34
NEW CASSEL	697	37	66.6	27**	11.8	16
NEW HYDE PARK	1,269	19	133.8	3	11.3	17
NORTH BALDWIN	8	118*	-	-	-	-
N. BELLMORE	724	36	36.2	70	5.3	48**
NORTH HILLS	204	73	71.4	22	6.6	41**
N. LAWRENCE	391	53	-	-	-	-
N. LONG BEACH	337	58	-	-	-	-
N. LYNBROOK	42	102	-	-	-	-
N. MASSAPEQUA	803	34	38.3	65	7.5	33**
N. MERRICK	502	48	40.2	62	6.7	40**
N. NEW HYDE PARK	634	39	43.6	58	5.0	51**
N. SEAFORD	71	92	-	-	-	-
N. VALLEY STREAM	372	54	25.7	86	4.6	54**
N. WANTAGH	88	87	6.7	105	.5	74
N. WOODMERE	252	68	-	-	-	-
OCEANSIDE	1,611	13	48.1	51	5.6	46**
OLD BETHPAGE	212	72	33.5	72	7.1	36
OLD BROOKVILLE/ BROOKVILLE/UPPER BROOKVILLE	359	56	52.7	44	5.2	49**

Following is a table showing the rank order of Nassau County Areas frequented by County residents.

APPENDIX B-1 1987

<u>OTHER AREAS</u>	<u># OF CRIMES</u>	<u>RANK</u>	<u>CRIMES PER 1,000</u>	<u>RANK</u>	<u>IMPACT CRIMES PER 1,000</u>	<u>RANK</u>
BELMONT RACE TRACK	90	6	---	---	---	---
EISENHOWER PARK	20	10	---	---	---	---
GREEN ACRES*	1,291	2	---	---	---	---
MID ISLAND*	248	4	---	---	---	---
MITCHEL FIELD	19	11	---	---	---	---
NASSAU COLISEUM	79	7	---	---	---	---
ROOSEVELT FIELD*	1,333	1	---	---	---	---
ROOSEVELT RACEWAY	45	9	---	---	---	---
SEARS SHOPPING CENTER	66	8	---	---	---	---
SUNRISE CINEMA	218	5	---	---	---	---
SUNRISE MALL*	928	3	---	---	---	---

\*SHOPPING CENTER

## APPENDIX B 1987

<u>COMMUNITY</u>	<u># OF CRIMES</u>	<u>RANK</u>	<u>CRIMES PER 1,000</u>	<u>RANK</u>	<u>IMPACT CRIMES PER 1,000</u>	<u>RANK</u>
OLD WESTBURY	179	75	49.9	48	6.7	40**
OYSTER BAY	317	60	42.5	60	7.0	37**
OYSTER BAY COVE	15	115	6.5	106	2.2	67**
PLAINEDGE	35	107	3.7	107	1.0	72*
PLAINVIEW	1,437	16	52.1	45	8.6	27**
PLANDOME	28	109**	19.1	96**	5.4	47
PLANDOME HEIGHTS	12	116	12.6	102	1.0	72**
PLANDOME MANOR	17	114	18.4	97	3.2	62**
PORT WASHINGTON	1,801	9	95.4	13	3.9	57**
ROCKVILLE CENTRE	1,387	17	55.5	41	7.0	37**
ROOSEVELT	1,503	14	103.1	9	19.8	3
ROSLYN	246	69	109.2	8	16.9	7
ROSLYN ESTATES	54	95	43.7	57	4.9	52**
ROSLYN HARBOR	28	109**	24.4	89	2.6	66
ROSLYN HEIGHTS	512	46	81.4	16	14.3	10
RUSSELL GARDENS	23	111	17.1	99	5.2	49**
SADDLE ROCK	36	106**	37.7	67	10.5	21**
SANDS POINT	43	101**	15.8	100	1.5	70
SEA CLIFF	152	78	28.2	83	6.7	40**
SEAFORD	858	32	54.0	43**	6.3	42
SEARINGTOWN	150	80	29.0	81	7.2	35**
S. FARMINGDALE	362	55**	23.0	91**	5.2	49**
S. FLORAL PARK	35	107**	21.3	93	3.0	63**
SOUTH HEMPSTEAD	141	81	44.0	56**	10.3	23**
S. VALLEY STREAM	78	90**	15.0	101**	2.9	64
STEWART MANOR	59	94	23.8	90	5.7	45
SYOSSET	1,059	27	101.8	10	17.5	5
THOMASTON	78	90**	29.5	79	3.0	63**
UNIONDALE	1,245	20	64.0	32	12.1	15
VALLEY STREAM	2,230	6	64.3	31	8.5	28
WANTAGH	1,210	22	59.4	34	7.7	31
W. FARMINGDALE	4	120	-	-	-	-
WEST HEMPSTEAD	1,076	36	59.8	33	9.2	25**
WESTBURY	1,717	10	124.6	7	19.0	4
WILLISTON PARK	302	62	38.6	64**	4.9	52**
WOODBURY	514	45	66.6	27**	4.3	56
WOODMERE	474	50	29.6	78	3.2	62**
WOODSBURGH	25	110	29.4	80	4.7	53**

**NASSAU COUNTY**  
**CRIMINAL JUSTICE COORDINATING COUNCIL**  
**AN ANALYSIS OF**  
**YOUTH CRIME**  
**IN**  
**NASSAU COUNTY**  
**1988**

THE FOLLOWING OBSERVATIONS ARE BASED UPON  
AN ANALYSIS OF YOUTH ARRESTS DATA FOR  
1983-1988 FOR THE COUNTY OF NASSAU

The total number of Part I arrests for youths decreased by 19% from 1983 to 1988 while all arrests for youths decreased by 9.9% from 1983 to 1988.

When comparing arrests for the 15 and under age group for 1983-1988 we note a 12.6% decrease in the number of arrests. The 16-21 group also showed a decrease of 9.5% when comparing 1983 to 1988.

It should be noted that the 21 and under age group represents 21.3% of the total population.

In 1983 the 21 and under groups accounted for 52.8% of all Part I arrests while in 1988 the same group accounted for 40.2% of all Part I arrests.

AN ANALYSIS OF YOUTH CRIME 1987-1988

TABLE I ARRESTS PART I CRIMES 21 AND UNDER

A review of this table indicates no appreciable change in the overall arrests for youth from 1987 to 1988.

TABLE II ARRESTS FOR ALL CRIMES BY YOUTHS

A review of this table shows a decrease of 2.3% from 1987-1988 in the number of youths arrested. As in our prior analysis the percentage of male to female arrestees 21 and under remained relatively constant.

TABLE III ARRESTS FOR YOUTHS 15 AND UNDER

TABLE IV ARRESTS FOR YOUTHS 16 TO 21 YEARS

A review of Table III shows a decrease of 4.7% from 1987-1988 in the number of youths arrested. Table IV shows a 1% increase from 1987-1988 in the number of youths arrested.

A higher percentage of 15 and under youths were arrested for Burglary (9.4%) than 16-21 youths (4.5%). Youths in the 16-21 group were arrested more frequently for Narcotics (15.9%) than youths 15 and under (4.3%)



TABLE I ARRESTS

<u>PART I CRIMES</u> <u>(21 &amp; Under)</u>	<u>1983</u>	<u>1984</u>	<u>1985</u>	<u>1986</u>	<u>1987</u>	<u>1988</u>	<u>NCPD</u> <u>ONLY</u> <u>1988</u>	
MURDER*	15	16	19	23	18	14	8	
RAPE	19	12	14	6	20	15	10	
ROBBERY	409	258	312	235	245	201	127	
ASSAULT	250	266	276	297	298	278	166	
BURGLARY	847	608	551	457	445	398	294	
LARCENY	1,649	1,659	1,702	1,689	1,696	1,646	1,366	
AUTO THEFT	116	106	108	154	119	122	90	
Total 21 & Under	3,305	2,925	2,982	2,861	2,841	2,674	2,061	
TOTAL PART I ARRESTS FOR NASSAU CTY.	6,260	5,867	6,021	6,102	6,674	6,644	4,866	
PERCENT OF PART I CRIME ARRESTS OF 21 & UNDER	52.8%	49.9%	49.5%	46.9%	42.6%	40.2%	42.4%	
<u>TOTAL VIOLENT CRIME ARRESTS FOR NASSAU COUNTY</u>	1,284 (1983), 1,188 (1984), 1,266 (1985) 1,300 (1986) 1,405, (1987) 1,353 (1988)							
<u>TOTAL PROPERTY CRIME ARRESTS FOR NASSAU COUNTY</u>	4,970 (1983), 4,677 (1984), 4,755 (1985), 4,802 (1986) 5,269, (1987) 5,291 (1988)							
<u>TOTAL POPULATION OF NASSAU COUNTY**</u>	1,322,988							
Population 10 to 21***	282,039							
PERCENT OF POPULATION 21 & UNDER	21.3%		1983	1984	1985	1986	1987	1988
Ratio of Property Crime Arrests to Violent Crime Arrests for Nassau County			.2584	.2540	.2662	.2707	.2667	.2557
Ratio of Property Crime Arrests to Violent Crime Arrests for Nassau County Ages 10-21			.2653	.2326	.2630	.2439	.2571	.2331

\* Includes Negligent and Non-Negligent Manslaughter

\*\* Population Statistics - Long Island Regional Planning Bd. - Population Survey 1988

\*\*\* Total Population 1-21 431,908 - Population Survey 1986

TABLE II

Table II displays the age and sex characteristics of all youthful offenders arrested from 1983-1988

<u>AGE</u>	<u>1983</u>	<u>1984</u>	<u>1985</u>	<u>1986</u>	<u>1987</u>	<u>1988</u>
Under 10	18	27	25	22	24	25
10-12	159	142	139	142	152	149
13	243	222	209	217	183	159
14	364	358	456	310	365	341
15 (15.5%)	519 (16.2%)	526 (17.4%)	566 (16.8%)	609 (15.8%)	471 (15.1%)	465
16	852	852	917	900	830	784
17	1,230	1,010	1,024	1,048	1,118	1,113
18	1,433	1,200	1,253	1,189	1,190	1,179
19	1,291	1,223	1,103	1,110	1,101	1,156
20	1,230	1,146	1,232	1,075	1,020	1,058
<u>21 (84.5%)</u>	<u>1,056 (83.8%)</u>	<u>1,158 (82.6%)</u>	<u>1,089 (83.2%)</u>	<u>1,113 (84.2%)</u>	<u>1,104 (84.9%)</u>	<u>1,131</u>
Total 21 & Under	8,395	7,864	8,013	7,735	7,558	7,560
TOTAL NASSAU COUNTY ARRESTS (ALL AGES)	20,935	21,138	21,978	21,706	22,061	23,883
PERCENT OF ARRESTS 21 & UNDER	40.1%	37.2%	36.5%	35.6%	34.3%	31.7%
<u>SEX - 21 UNDER</u>						
MALES	(85.8%) 7,201	(84.8%) 6,669	(84.1%) 6,735	(84.4%) 6,528	(83.6%) 6,318	(84.9%) 6,415
FEMALES	(14.2%) 1,194	(15.2%) 1,195	(16.0%) 1,278	(15.6%) 1,207	(16.0%) 1,207	(15.1%) 1,145

TABLE III

<u>15 YRS OF AGE &amp; Under Category</u>	<u>1988</u>		<u>1987</u>		<u>1986</u>	
	<u>NUMBER</u>	<u>PERCENT</u>	<u>NUMBER</u>	<u>PERCENT</u>	<u>NUMBER</u>	<u>PERCENT</u>
ASSAULT <sup>1</sup>	33	2.9%	44	3.7%	38	2.9%
ROBBERY	29	2.5%	42	3.5%	43	3.3%
BURGLARY	107	9.4%	114	9.5	151	11.6%
LARCENY	254	22.3%	295	24.7%	373	28.7%
NARCOTICS	49	4.3%	52	4.4%	31	2.4%
TRAFFIC <sup>2</sup>	16	1.4%	21	1.8%	18	1.4%
DISORDERLY CONDUCT <sup>3</sup>	42	3.7%	26	2.2%	27	2.1%
CRIMINAL MISCHIEF	121	10.6%	149	12.5%	147	11.3%
ALL OTHER	<u>488</u>	<u>42.8%</u>	<u>452</u>	<u>37.8%</u>	<u>472</u>	<u>36.3%</u>
TOTAL	1,139		1,195		1,300	

<u>15 YRS. OF AGE &amp; Under CATEGORY</u>	<u>1985</u>		<u>1984</u>		<u>1983</u>	
	<u>NUMBER</u>	<u>PERCENT</u>	<u>NUMBER</u>	<u>PERCENT</u>	<u>NUMBER</u>	<u>PERCENT</u>
ASSAULT <sup>1</sup>	41	2.9%	41	3.2%	41	3.1%
ROBBERY	56	4.0%	41	3.2%	80	6.1%
BURGLARY	154	11.0%	196	15.4%	257	19.7%
LARCENY	367	26.3%	318	24.9%	326	25.0%
NARCOTICS	27	1.9%	31	2.4%	34	2.6%
TRAFFIC <sup>2</sup>	15	1.1%	21	1.6%	12	.9%
DISORDERLY CONDUCT <sup>3</sup>	46	3.3%	32	2.5%	21	.9%
CRIMINAL MISCHIEF	259	18.6%	199	15.6%	125	9.6%
ALL OTHER <sup>4</sup>	<u>430</u>	<u>30.8%</u>	<u>396</u>	<u>31.1%</u>	<u>416</u>	<u>31.9%</u>
TOTAL	1,395		1,275		1,303	

1. Aggravated Assault
2. D.W.I. & Unauthorized use of a motor vehicle
3. The Disorderly Conduct Offense for those under 15 years of age is generally not reported as an arrestable crime by the Nassau County Police Department. This analysis has included this statistic in that such offenses were not reported as arrests by Independent Police Departments.
4. All other crimes.

THE NEXT TABLE DISPLAYS YOUTHFUL ARRESTS BY OFFENSES FOR THE 16-21 YEARS OF AGE FOR 1983-1988

TABLE IV

<u>16 Yrs. to 21 Yrs.</u> <u>Category</u>	<u>1988</u>		<u>1987</u>		<u>1986</u>	
	<u>NUMBER</u>	<u>PERCENT</u>	<u>NUMBER</u>	<u>PERCENT</u>	<u>NUMBER</u>	<u>PERCENT</u>
ASSAULT <sup>1</sup>	245	3.8%	254	4.0%	259	4.0%
ROBBERY	172	2.7%	203	3.2%	192	2.9%
BURGLARY	291	4.5%	331	5.2%	306	4.8%
LARCENY	1,392	21.7%	1,401	22.0%	1,316	20.5%
NARCOTICS	1,019	15.9%	834	13.1%	819	12.7%
TRAFFIC <sup>2</sup>	635	9.9%	644	10.1%	690	10.7%
DISORDERLY CONDUCT <sup>3</sup>	223	3.5%	248	3.9%	211	3.3%
CRIMINAL MISCHIEF	289	4.5%	343	5.4%	373	5.8%
ALL OTHER <sup>4</sup>	2,155	33.6%	2,105	33.1%	2,269	35.3%
TOTAL	6,421		6,363		6,435	

<u>16 Yrs. to 21 Yrs.</u> <u>Of Age</u> <u>Category</u>	<u>1985</u>		<u>1984</u>		<u>1983</u>	
	<u>NUMBER</u>	<u>PERCENT</u>	<u>NUMBER</u>	<u>PERCENT</u>	<u>NUMBER</u>	<u>PERCENT</u>
ASSAULT <sup>1</sup>	235	3.6%	225	3.4%	205	2.9%
ROBBERY	256	3.9%	221	3.4%	337	4.8%
BURGLARY	379	5.7%	422	6.4%	585	8.2%
LARCENY	1,338	20.2%	1,341	20.3%	1,315	18.5%
NARCOTICS	633	9.6%	700	10.6%	638	8.9%
TRAFFIC <sup>2</sup>	846	12.8%	972	14.8%	876	12.4%
DISORDERLY CONDUCT <sup>3</sup>	234	3.5%	267	4.1%	261	3.7%
CRIMINAL MISCHIEF	414	6.3%	363	5.5%	287	4.0%
ALL OTHER <sup>4</sup>	2,283	34.5%	2,078	31.5%	2,588	36.5%
TOTAL	6,618		6,589		7,092	

1. Aggravated Assault
2. D.W.I. & Unauthorized use of a motor vehicle
3. The Disorderly Conduct Offense for those under 15 yrs. of age is generally not reported as an arrestable crime by the Nassau County Police Department. This Analysis has included this statistic in that such offenses were reported as arrests by Independent Police Departments.
4. All Other crimes.

APPENDIX A

AGE DISTRIBUTION 1970 AND 1980 NASSAU COUNTY

<u>AGE COHORT (Years)</u>	<u>1970</u>		<u>1980</u>		<u>ABSOLUTE CHANGE</u>	<u>PERCENT CHANGE</u>
	<u>NO. OF PERSONS</u>	<u>PERCENT OF TOTAL</u>	<u>NO. OF PERSONS</u>	<u>PERCENT OF TOTAL</u>		
0-4	98,105	6.9%	68,878	5.2%	- 29,227	- 29.8%
5-9	137,474	9.6%	80,991	6.1%	- 56,483	- 41.1%
10-14	163,042	11.4%	108,854	8.2%	- 54,188	- 33.2%
15-19	146,708	10.3%	127,698	9.7%	- 19,010	- 13.0%
20-24	89,154	6.2%	108,519	8.2%	19,365	21.7%
25-29	67,649	4.7%	90,751	6.9%	23,102	34.1%
30-34	68,241	4.8%	90,924	6.9%	22,683	33.2%
35-44	195,463	13.7%	154,017	11.7%	- 41,446	- 21.2%
45-54	217,520	15.3%	179,600	13.5%	- 37,920	- 17.4%
55-59	76,648	5.4%	97,311	7.4%	20,663	27.0%
60-64	55,894	3.9%	73,643	5.6%	17,749	31.7%
65-74	70,082	4.9%	85,701	6.5%	15,619	22.3%
75- & Over	<u>42,100</u>	2.9%	<u>54,695</u>	4.1%	<u>12,595</u>	29.9%
	1,428,080*	100.0%	1,321,582	100.0%	- 106,498	- 7.5%

\*Total County population figure for 1970 was revised subsequent to the releasing of the age data. Therefore, the age cohorts do not sum up to the revised County total of 1,428,838 persons.

Source: Nassau County Planning Commission  
 "Nassau County-Age of Population 1970-1980"  
 U.S. Census

**NASSAU COUNTY**  
**CRIMINAL JUSTICE COORDINATING COUNCIL**  
**AN ANALYSIS OF**  
**INMATE POPULATION**  
**IN**  
**NASSAU COUNTY CORRECTIONAL CENTER**  
**1988**

Our analysis of persons ADMITTED to the Nassau County Correctional Center indicates that there was an overall increase of 27.9% when comparing 1987 to 1988. When we compare the number of persons ADMITTED for the period of 1984 to 1988 we note a 37.9% increase.

When comparing 1987 to 1988 there was a 24.1% increase in the number of white persons and 27.7% increase in the number of black persons ADMITTED to the Center. In comparing 1984 to 1988 admissions to the Nassau County Correctional Center there was an 6.5% increase in the number of white persons and 58.2% increase in the number of black persons.

Our analysis of 1987 to 1988 indicates that there was an overall increase of 34.2% in the number of persons SENTENCED to the Correctional Center. Comparing 1984 to 1988 we note a 20.2% increase in the number of persons SENTENCED to the Correctional Center.

We note that during the period of 1984-1988 over 50% of the persons ADMITTED to the Correctional Center had a High School education or better.

ANALYSIS OF INMATE CHARACTERISTICS  
NASSAU COUNTY CORRECTIONAL CENTER\*

TABLE I

ADMITTED TO NASSAU COUNTY CORRECTIONAL CENTER

CHARACTERISTICS

SEX	1988	% OF TOTAL	1987	% OF TOTAL	1986	% OF TOTAL	1985	% OF TOTAL	1984	% OF TOTAL
MALE	9,348	86.6%	7,406	87.7%	7,257	87.9%	7,784	89.3%	7,040	89.9%
FEMALE	1,450	13.4%	1,038	12.3%	995	12.1%	937	10.7%	793	10.1%
TOTAL	10,798		8,444		8,252		8,721		7,833	
RACE	1988	% OF TOTAL	1987	% OF TOTAL	1986	% OF TOTAL	1985	% OF TOTAL	1984	% OF TOTAL
WHITE	3,853	35.7%	3,106	36.8%	3,444	41.7%	4,085	46.8%	3,619	46.2%
BLACK	5,915	54.8%	4,631	54.8%	4,223	51.2%	4,092	46.9%	3,738	47.7%
HISPANIC	750	6.9%	699	8.3%	576	7.0%	331	3.8%	196	2.5%
OTHERS	280	2.6%	8	.1%	9	.1%	213	2.4%	280	3.6%
TOTAL	10,798		8,444		8,252		8,721		7,833	
AGE	1988	% OF TOTAL	1987	% OF TOTAL	1986	% OF TOTAL	1985	% OF TOTAL	1984	% OF TOTAL
16-18	1,003	9.3%	939	11.1%	814	9.9%	963	11.0%	902	11.5%
19-20	1,090	10.1%	878	10.4%	895	10.8%	994	11.4%	856	10.9%
21-29	4,888	45.3%	3,826	45.3%	3,802	46.1%	3,847	44.1%	3,417	43.6%
30-39	2,696	25.0%	2,004	23.7%	1,907	23.1%	1,931	22.1%	1,738	22.2%
40-54	930	8.6%	652	7.7%	703	8.5%	804	9.2%	770	9.8%
55-64	169	1.6%	108	1.3%	97	1.2%	152	1.7%	124	1.6%
65 Over	22	.2%	37	.4%	34	.4%	30	.3%	26	.3%
TOTAL	10,798		8,444		8,252		8,721		7,833	



ANALYSIS OF INMATE CHARACTERISTICS  
NASSAU COUNTY CORRECTIONAL CENTER \*

TABLE I (CONTINUED)

ADMITTED TO NASSAU COUNTY CORRECTIONAL CENTER

CHARACTERISTICS

EDUCATION	1988	% OF TOTAL	1987	% OF TOTAL	1986	% OF TOTAL	1985	% OF TOTAL	1984	% OF TOTAL
UNDER 4th	123	1.1%	93	1.1%	75	.9%	100	1.1%	73	.9%
4-7th	521	4.8%	379	4.5%	405	4.9%	495	5.7%	417	5.3%
8-12th	4,366	40.4%	3,672	43.5%	3,436	41.6%	3,579	41.0%	3,270	41.7%
H.S. GRAD	4,186	38.8%	3,032	35.9%	3,080	37.3%	3,158	36.2%	2,823	36.0%
ATTENDED COLLEGE	1,285	11.9%	1,005	11.9%	987	12.0%	1,076	12.3%	1,004	12.8%
COLLEGE GRADUATE	317	2.9%	263	3.1%	269	3.3%	313	3.6%	246	3.1%
TOTAL	10,798		8,444		8,252		8,721		7,833	

\*Sheriff's Report 1984-1988

1 16-17

2 18-20

ANALYSIS OF INMATE CHARACTERISTICS  
NASSAU COUNTY CORRECTIONAL CENTER\*

TABLE II

SENTENCED TO NASSAU COUNTY CORRECTIONAL CENTER

CHARACTERISTICS

AGE	1988	% OF TOTAL	1987	% OF TOTAL	1986	% OF TOTAL	1985	% OF TOTAL	1984	% OF TOTAL
16-18	200	6.7%	148	6.7%	166	7.7%	114	4.5%	246	9.9%
19-20	306	10.3%	536	24.2%	346	16.0%	373	14.7%	305	12.3%
21-29	1,409	47.4%	762	34.4%	925	42.7%	1,202	47.3%	1,087	43.9%
30-39	758	25.5%	554	25.0%	508	23.4%	540	21.3%	558	22.5%
40-54	258	8.7%	186	8.4%	183	8.4%	258	10.1%	229	9.3%
55-64	31	1.0%	21	.9%	32	1.5%	46	1.8%	44	1.8%
65/over	12	.4%	9	.4%	7	.3%	8	.3%	6	.2%
TOTAL	2,974		2,216		2,167		2,541		2,475	

\*Sheriff's Report 1984-1988

1 16-17

2 18-20

**NASSAU COUNTY**

**CRIMINAL JUSTICE COORDINATING COUNCIL**

**AN ANALYSIS OF**

**FELONY CASE PROCESSING**

**IN**

**NASSAU COUNTY**

**1984 - 1988**

## PREFACE

### METHODOLOGY OF REPORT PREPARATION

The Criminal Justice Coordinating Council has prepared an analysis of Felony Case Processing comprising the years 1984 thru 1988. In preparing this study, CJCC has utilized the District Attorney's Management Information System known as D.A.I.S.. This computer system is programmed to follow the progress of criminal cases from their entry into the system and during their flow within the judicial system. This information system, CJCC believes, provides an accurate and detailed account of criminal case data in Nassau County.

What has emerged as a result of this coordinated effort is an ability to observe and analyze the processing of cases in Nassau County.

## SECTION I

### OVERVIEW OF FELONY CASE PROCESSING FLOW

Upon an arrest, the arrestee is brought to District Court Arraignment Part, where there is a reading of an accusatory instrument, together with a setting of bail. The defendant is then given the opportunity to retain a lawyer. If the defendant cannot afford one, a lawyer will be appointed by the Court.

The case then proceeds to the District Attorney's Screening Unit to determine the scope of prosecution. The case is placed on the Felony Screening calendar for conference. If a misdemeanor plea is agreed upon, the case is then disposed of in District Court. The defendant may request as a matter of right a felony examination (which is waived in the majority of cases). In the event defendant exercises the right to a felony examination, a hearing is held before a District Court Judge to determine if there is a reasonable cause to believe that a felony was committed by the defendant and whether the case should be held for the action of the Grand Jury. In any case, the defendant may request a pre-indictment conference in County Court where the matter may be disposed of through a plea of guilty to a Superior Court Information. If no plea is agreed upon the case will then be presented to the Grand Jury. If the Grand Jury hands up an indictment, the defendant will be arraigned in County Court and the case will then proceed to trial, unless the defendant pleads guilty to the highest count of the indictment.

NASSAU COUNTY  
 FELONY CASE PROCESSING FLOW  
 GRAPH ONE

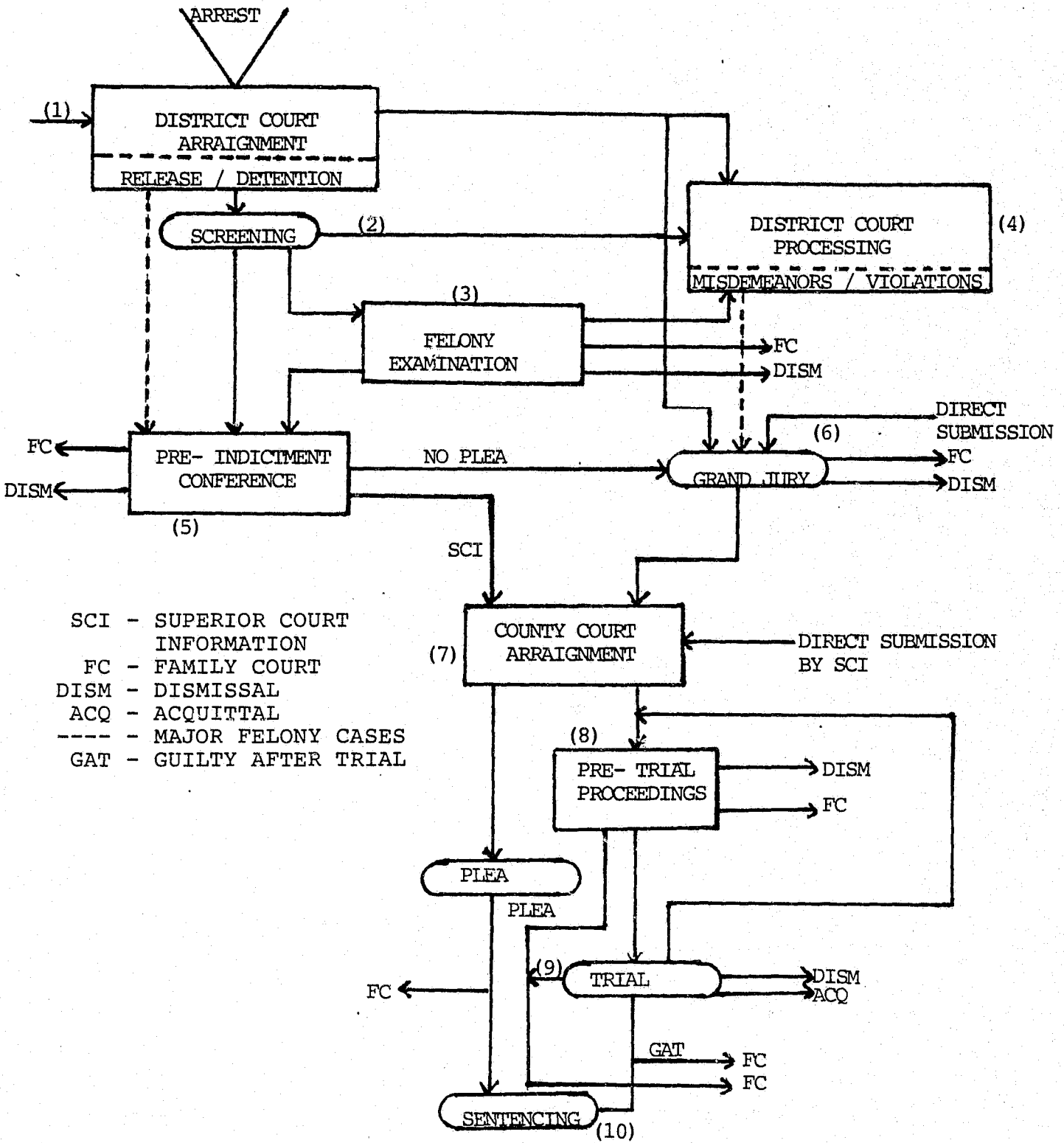

COUNTY COURT CASE PROCESSING

Table IA

Total Felony Cases Processed

<u>Cases Processed (District Court)</u>			Total Cases 1984-1985		Total Cases 1984-1986		Total Cases 1984-1987		Total Cases 1984-1988
	<u>1984</u>	<u>1985</u>	<u>%Change</u>	<u>1986</u>	<u>%Change</u>	<u>1987</u>	<u>%Change</u>	<u>1988</u>	<u>%Change</u>
	5075	5417	6.7%	5465	7.7%	5375	5.9%	6230	22.8%

Table IB

Total Felony Cases Disposed

			Total Cases 1984-1985		Total Cases 1984-1986		Total Cases 1984-1987		Total Cases 1984-1988
	<u>1984</u>	<u>1985</u>	<u>%Change</u>	<u>1986</u>	<u>%Change</u>	<u>1987</u>	<u>%Change</u>	<u>1988</u>	<u>%Change</u>
<u>Dispositions (District Court)</u>	2475	2517	1.7%	2823	14.0%	2634	6.4%	2882	16.4%
<u>Dispositions (County Court)</u>	2467	2409	-2.4%	2788	13.0%	5753	11.6%	3359	36.2%
TOTAL	4942	4926	-.3%	5611	13.5%	5387	9.0%	6241	26.3%

Table II compares the percentages of occurrence of various forms of felony dispositions in the Nassau County Court System with the Statewide averages. As indicated, Nassau County has a significantly higher conviction rate and correspondingly low acquittal rate than the Statewide average. It should be noted that with the exception of category C, below, DCJS data is utilized in this table in the interest comparability.

TYPES OF DISPOSITIONS: NASSAU COUNTY vs.  
NEW YORK STATE 1984-1985-1986-1987-1988

Table II

<u>1984</u>	<u>1984</u> <u>NASSAU COUNTY</u>		<u>1984</u> <u>NEW YORK STATE*</u>	
A. Dismissed	277	5.8%	2,787	6.3%
B. Acquitted	69	1.4%	1,229	2.8%
C. Convicted	4,266	90.0%	38,268	87.0%
D. Guilty Pleas	4,098	86.2%	35,147	79.9%
E. Guilty After Trial	168	3.5%	3,121	7.0%
F. Dismissed in Satisfaction, Plea to Indictment/SCI	139	2.9%	1,674	3.8%
Total Dispositions= A+B+C+F	4,751		43,958	

\*DCJS Case Processing Data

<u>1985</u>	<u>1985</u> <u>NASSAU COUNTY</u>		<u>1985</u> <u>NEW YORK STATE*</u>	
A. Dismissed	264	5.5%	2,421	5.4%
B. Acquitted	45	1.0%	1,209	2.7%
C. Convicted	4,372	91.2%	39,753	88.5%
D. Guilty Pleas	4,199	87.6%	36,580	81.4%
E. Guilty After Trial	173	3.6%	3,173	7.1%
F. Dismissed in Satisfaction, Plea to Indictment/SCI	114	2.4%	1,530	3.4%
Total Dispositions= A+B+C+F	4,795		44,913	

\*DCJS Case Processing Data

Explanatory Note:

For Nassau County Data, C=D+E  
For New York State Data, C=D+E



TYPE OF DISPOSITIONS: NASSAU COUNTY vs. NEW YORK STATE

1984-1985-1986-1987-1988

Table II Cont'd)

1986

	<u>1986</u> <u>NASSAU COUNTY</u>		<u>1986</u> <u>NEW YORK STATE*</u>	
A. Dismissed	363	6.7%	2,719	5.6%
B. Acquitted	70	1.3%	1,171	2.4%
C. Convicted	4,869	90.0%	42,842	88.5%
D. Guilty Pleas	4,692	86.7%	39,702	82.0%
E. Guilty After Trial	177	3.3%	3,140	6.5%
F. Dismissed in Satisfaction, Plea to Indictment/SCI	111	2.1%	1,671	3.5%
Total Dispositions= A+B+C+F	5,413		48,403	

\*DCJS Case Processing Data

1987 & 1988

	<u>1987</u> <u>NASSAU COUNTY</u>		<u>1987</u> <u>NEW YORK STATE*</u>		<u>1988</u> <u>NASSAU COUNTY</u>		<u>1988</u> <u>NEW YORK STATE*</u>	
A. Dismissed	320	6.2%	3,110	5.5%	312	5.2%	3,454	5.9%
B. Acquitted	55	1.1%	1,243	2.2%	35	N/A	1,217	2.1%
C. Convicted	4,679	90.1%	49,908	88.8%	5,465	90.3%	52,063	89.3%
D. Guilty Pleas	4,527	87.1%	46,744	83.2%	5,334	88.1%	49,215	84.4%
E. Guilty After Trial	152	2.9%	3,164	5.6%	131	2.2%	2,848	1.5%
F. Dismissed in Satisfaction, Plea to Indictment/SCI	142	2.7%	1,955	3.5%	240	4.0%	1,570	2.7%
Total Dispositions= A+B+C+F	5,196		56,216		6,052		58,304	

\*DCJS Case Processing Data

For Nassau County Data, C=D+E  
For New York State Data, C=D+E

A. Dispositions

Table III outlines the content of all Felony Dispositions in County Court. Where percentage changes are statistically insignificant (less than 1%) they are listed as not applicable. (N/A)

TYPES OF DISPOSITIONS  
ALL FELONIES - COUNTY COURT

TABLE III

	<u>1984</u>	<u>Total Cases %1984</u>	<u>1985</u>	<u>Total Cases %1985</u>	<u>Total Cases 1984-85 %Change</u>
A. Convictions by Plea	1,967	80%	1,978	82%	N/A
B. Convictions After Trial	145	6%	157	7%	8.3%
C. Acquittal	51	2%	33	1%	-35.3%
D. D.I.S.*	132	5%	54	2%	-59.1%
E. Dismissals	59	2%	65	3%	10.2%
F. Transfer to Other Courts	6	N/A	3	N/A	-50 %
G. No True Bill	99	4%	119	5%	20.2%
<b>TOTAL</b>	<b>2,459</b>		<b>2,409</b>		

	<u>1986</u>	<u>Total Cases %1986</u>	<u>Total Cases 1984-86 %Change</u>	<u>1987</u>	<u>Total Cases %1987</u>	<u>Total Cases 1984-87 %Change</u>
A. Convictions by Plea	2,273	82%	15.6%	2,237	81%	13.7%
B. Convictions After Trial	153	5%	5.5%	142	5%	- 2.1%
C. Acquittal	51	2%	N/A	40	1%	-21.6%
D. D.I.S.*	38	1%	-71.2%	79	3%	-40.2%
E. Dismissals	84	3%	42.4%	76	3%	28.8%
F. Transfer to Other Courts	3	N/A	-50 %	4	N/A	-33.3%
G. No True Bill	186	7%	87.9%	175	6%	76.8%
<b>TOTAL</b>	<b>2,788</b>			<b>2,753</b>		

\*Case dismissed in satisfaction of other pleas.

Note: The base rate of conviction can be determined by considering total of A and B as a percentage of totals A, B, C, E. By this we determine the base rate of convictions was 95.0% for 1984, 95.6% for 1985, 94.7% for 1986, 95.4% for 1987 & 96.5% for 1988.

Table III (Cont'd)

TYPES OF DISPOSITIONS  
ALL FELONIES - COUNTY COURT

	<u>**1984</u>	<u>Total Cases %1984</u>	<u>1988</u>	<u>Total Cases %1988</u>	<u>Total Cases 1984-88 %Change</u>
A. Convictions by Plea	1,967	80%	2,781	83%	41.4%
B. Convictions After Trial	145	6%	121	4%	-16.6%
C. Acquittal	51	2%	24	1%	-52.9%
D. D.I.S.*	132	5%	175	5%	32.6%
E. Dismissals	59	2%	80	2%	35.6%
F. Transfer to Other Courts	6	N/A	2	N/A	-66.7%
G. No True Bill	<u>99</u>	4%	<u>176</u>	5%	77.8%
TOTAL	2,459		3,359		

\*\*We report 1984 statistics for purposes of comparison with 1988.

\*Case dismissed in satisfaction of other pleas.

Note: The base rate of conviction can be determined by considering total of A and B as a percentage of totals A,B,C,E. By this we determined the base rate of convictions was 95% for 1984, 95.6% for 1985, 94.7% for 1986, 95.4% for 1987 & 96.5% for 1988.

TABLE IV

TYPES OF DISPOSITIONS  
ROBBERY - COUNTY COURT

<u>ROBBERY</u>	<u>1984</u>	<u>Total Cases %1984</u>	<u>1985</u>	<u>Total Cases %1985</u>	<u>Total Cases 1984-1985 %Change</u>
A. Convictions by Plea	359	78%	234	77%	- 34.8%
B. Convictions After Trial	35	8%	34	11%	- 2.9%
C. Acquittal	18	4%	3	N/A	- 83.3%
D. D.I.S.	27	6%	5	2%	- 81.5%
E. Dismissals	7	2%	9	3%	28.6%
F. Transfer to Other Courts	1	N/A	2	N/A	100 %
G. No True Bill	<u>14</u>	3%	<u>16</u>	5%	14.3%
TOTAL	461		303		

<u>ROBBERY</u>	<u>1986</u>	<u>Total Cases %1986</u>	<u>Total Cases 1984-1986 %Change</u>	<u>1987</u>	<u>Total Cases 1987</u>	<u>Total Cases 1984-1987 %Change</u>	<u>1988</u>	<u>Total Cases 1988</u>	<u>Total Cases 1984-1988 %Change</u>
A. Convictions by Plea	294	71%	- 18.1%	268	75%	- 25.3%	271	71%	- 24.5%
B. Convictions After Trial	45	11%	28.6%	20	6%	- 42.9%	19	5%	- 45.7%
C. Acquittal	20	5%	11.1%	11	3%	- 38.9%	4	1%	- 77.8%
D. D.I.S.	6	1%	- 77.8%	18	5%	- 33.4%	44	11%	63 %
E. Dismissals	17	4%	142.9%	10	3%	42.9%	7	2%	N/A
F. Transfer to Other Courts	1	N/A	N/A	1	N/A	N/A	2	N/A	100 %
G. No True Bill	<u>34</u>	8%	142.9%	<u>28</u>	8%	100 %	<u>36</u>	9%	157.1%
TOTAL	417			356			383		

TABLE IV (Cont'd)

TYPES OF DISPOSITIONS  
BURGLARY - COUNTY COURT

<u>BURGLARY</u>	<u>1984</u>	<u>Total Cases %1984</u>	<u>1985</u>	<u>Total Cases %1985</u>	<u>Total Cases 1984-1985 %Change</u>
A. Convictions by Plea	461	80%	446	89%	- 3.3%
B. Convictions After Trial	36	6%	21	4%	- 41.7%
C. Acquittal	9	2%	2	N/A	- 77.8%
D. D.I.S.	37	6%	11	2%	- 70.3%
E. Dismissals	14	2%	7	1%	- 50 %
F. Transfer to Other Courts	2	N/A	0	N/A	-100 %
G. No True Bill	<u>16</u>	3%	<u>15</u>	3%	- 6.3%
<b>TOTAL</b>	<b>575</b>		<b>502</b>		

<u>BURGLARY</u>	<u>1986</u>	<u>Total Cases %1986</u>	<u>Total Cases 1984-86 %Change</u>	<u>1987</u>	<u>Total Cases %1987</u>	<u>Total Cases 1984-87 %Change</u>	<u>1988</u>	<u>Total Cases %1988</u>	<u>Total Cases 1984-88 %Change</u>
A. Convictions by Plea	443	87%	- 3.9%	364	83%	- 21.0%	353	82%	- 23.4%
B. Convictions After Trial	18	4%	- 50 %	20	5%	- 44.4%	19	4%	- 47.2%
C. Acquittal	6	1%	- 33.3%	8	2%	- 11.1%	1	N/A	- 88.9%
D. D.I.S.	8	2%	- 78.4%	17	4%	- 54.1%	35	8%	- 5.4%
E. Dismissals	12	2%	- 14.3%	6	1%	- 57.1%	9	2%	- 35.7%
F. Transfer to Other Courts	0	N/A	-100 %	0	N/A	-100 %	0	N/A	-100 %
G. No True Bill	<u>22</u>	4%	37.5%	<u>21</u>	5%	31.2%	<u>13</u>	3%	- 18.8%
<b>TOTAL</b>	<b>509</b>			<b>436</b>			<b>430</b>		

TABLE IV (Cont'd)

TYPE OF DISPOSITIONS  
NARCOTIC CASES - COUNTY COURT

<u>NARCOTICS</u>	<u>1986</u>	<u>Total Cases %1986</u>	<u>1987</u>	<u>Total Cases %1987</u>	<u>Total Cases 1986-1987 %Change</u>
A. Convictions by Plea	322	86%	568	90%	76.4%
B. Convictions after Trial	20	5%	25	4%	25 %
C. Acquittal	3	N/A	3	N/A	N/A
D. D.I.S.	7	2%	11	2%	57.1%
E. Dismissals	14	4%	14	2%	N/A
F. Transfer to Other Courts	0	N/A	0	N/A	N/A
G. No True Bill	8	2%	10	2%	25 %
<b>TOTAL</b>	<b>374</b>		<b>631</b>		

<u>NARCOTICS</u>	<u>1988</u>	<u>Total Cases %1988</u>	<u>Total Cases 1986-1988 %Change</u>
A. Convictions by Plea	956	92%	196.9%
B. Convictions After Trial	22	2%	10 %
C. Acquittal	3	N/A	N/A
D. D.I.S.	25	2%	257.1%
E. Dismissals	11	1%	- 21.4%
F. Transfer to Other Courts	0	N/A	N/A
G. No True Bill	17	2%	112.5%
<b>TOTAL</b>	<b>1,034</b>		

TYPES OF SENTENCES  
ALL FELONIES - COUNTY COURT

TABLE V

	1984	Total Cases %1984	1985	Total Cases %1985	Total Cases 1984-1985 %Change
A Incarceration (State)	713	34%	632	29%	- 11.4%
B Incarceration (Local)	705	34%	852	40%	20.9%
*C Probation	534	26%	538	25%	N/A
*D Conditional Discharge	10	N/A	7	N/A	- 30 %
*E Restitution Fine/Other	122	6%	108	5%	- 11.5%
F Unconditional Discharge	<u>2</u>	N/A	<u>7</u>	N/A	250 %
TOTAL	2,086		2,144		

When there are multiple sentence conditions, each defendant is counted once based on his or her most stringent sentence category (See Table V & VI).

	1986	Total Cases %1986	Total Cases 1984-86 %Change	1987	Total Cases %1987	Total Cases 1984-87 %Change	1988	Total Cases %1988	Total Cases 1984-1988 %Change
A Incarceration (State)	809	35%	13.5%	766	33%	7.4%	874	27%	22.6%
B Incarceration (Local)	798	35%	13.2%	824	36%	16.9%	1,186	37%	68.2%
*C Probation	550	24%	3 %	556	24%	4.1%	582	18%	9 %
*D Conditional Discharge	15	N/A	50 %	22	N/A	120 %	390	12%	380 %
*E Restitution Fine/Other	119	5%	- 2.5%	145	6%	18.9%	213	7%	74.6%
F Unconditional Discharge	<u>0</u>	N/A	-100 %	<u>4</u>	N/A	100 %	<u>3</u>	N/A	50 %
TOTAL	2,291			2,317			3,248		

\*These three are understated due to the statistical hierarchy referred to above.

TYPES OF SENTENCES  
ROBBERY - COUNTY COURT

TABLE VI

<u>ROBBERY</u>	<u>1984</u>	<u>Total Cases %1984</u>	<u>1985</u>	<u>Total Cases %1985</u>	<u>Total Cases 1984-1985 %Change</u>
A Incarceration (State)	216	55%	154	57%	- 28.7%
B Incarceration (Local)	108	28%	63	23%	- 41.7%
*C Probation	61	16%	49	18%	- 19.7%
*D Conditional Discharge	0	N/A	1	N/A	100 %
*E Restitution Fine/Other	5	1%	2	N/A	- 60 %
F Unconditional Discharge	<u>0</u>	N/A	<u>0</u>	N/A	N/A
TOTAL	390		269		

When there are multiple sentence conditions each defendant is counted once based on his or her most stringent sentence category (See Table V & VI).

<u>ROBBERY</u>	<u>1986</u>	<u>Total Cases %1986</u>	<u>Total Cases 1984-1986 %Change</u>	<u>1987</u>	<u>Total Cases %1987</u>	<u>Total Cases 1984-1987 %Change</u>	<u>1988</u>	<u>Total Cases %1988</u>	<u>Total Cases 1984-1988 %Change</u>
A Incarceration (State)	210	63%	- 2.8%	176	62%	- 18.5%	171	58%	- 20.8%
B Incarceration (Local)	79	24%	- 26.9%	60	21%	- 44.4%	83	28%	- 23.1%
*C Probation	47	14%	- 23 %	44	15%	- 27.9%	32	11%	- 47.5%
*D Conditional Discharge	0	N/A	N/A	1	N/A	100 %	1	N/A	100 %
*E Restitution Fine/Other	0	N/A	-100 %	4	1%	- 20 %	6	2%	20 %
F Unconditional Discharge	<u>0</u>	N/A	N/A	<u>0</u>	N/A	N/A	<u>0</u>	N/A	N/A
TOTAL	336			285			293		

\*These three are understated due to the statistical hierarchy referred to above.



TYPES OF SENTENCES  
BURGLARY - COUNTY COURT

TABLE VI (Cont'd)

BURGLARY	1984		1985		1986		1987		1988	
	Total Cases	%1984	Total Cases	%1985	Total Cases	%1986	Total Cases	%1987	Total Cases	%1988
A. Incarceration (State)	207	42%	180	38%	201	44%	176	47%	156	42%
B. Incarceration (Local)	149	30%	165	35%	126	28%	101	27%	120	32%
*C. Probation	128	26%	119	25%	122	27%	89	24%	76	20%
*D. Conditional Discharge	3	N/A	1	N/A	3	N/A	4	1%	8	2%
*E. Restitution Fine/Other	6	1%	8	2%	5	1%	2	N/A	14	4%
F. Unconditional Discharge	0	N/A	0	N/A	0	N/A	0	N/A	0	N/A
TOTAL	493		473		457		372		374	

\*These three are understated due to the statistical hierarchy referred to on p.

TABLE VI (Cont'd)

TYPES OF SENTENCES  
NARCOTIC CASES - COUNTY COURT

<u>NARCOTICS</u>	<u>1986</u>	<u>Total Cases %1986</u>	<u>1987</u>	<u>Total Cases %1987</u>	<u>Total Cases 1986-1987 %Change</u>
A. Incarceration (State)	149	44%	212	37%	42.3%
B. Incarceration (Local)	103	30%	235	41%	128.2%
*C. Probation	86	25%	128	22%	48.8%
*D. Conditional Discharge	0	N/A	0	N/A	N/A
*E. Restitution Fine/Other	2	N/A	3	N/A	50 %
F. Unconditional Discharge	<u>0</u>	N/A	<u>0</u>	N/A	N/A
TOTAL	340		578		

<u>NARCOTICS</u>	<u>1988</u>	<u>Total Cases %1988</u>	<u>Total Cases 1986-1988 %Change</u>
A. Incarceration (State)	335	34%	124.8%
B. Incarceration (Local)	440	45%	327.2%
*C. Probation	181	18%	110.5%
*D. Conditional Discharge	7	N/A	100 %
*E. Restitution Fine/Other	16	2%	700 %
F. Unconditional Discharge	<u>0</u>	N/A	N/A
TOTAL	979		

\*These three are understated due to the statistical hierarchy referred to on p.

GRAPH TWO - SENTENCES ON CONVICTION ON INDICTMENTS  
AND SUPERIOR COURT INFORMATION - COUNTY COURT

ALL FELONIES  
(See TABLE V PG. 82 )

1984

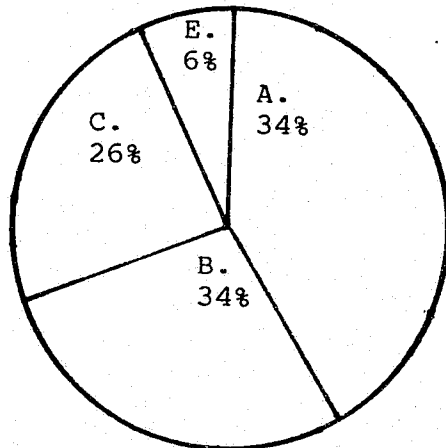

D & F No Significant %

1985

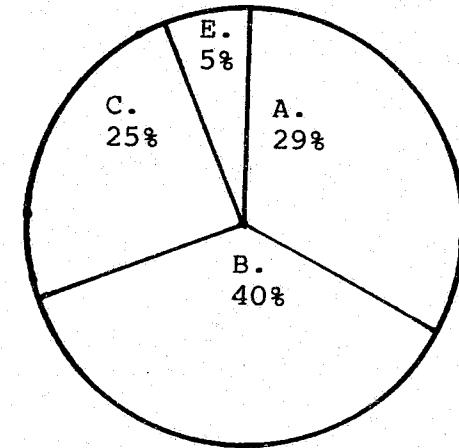

D & F No Significant %

1988

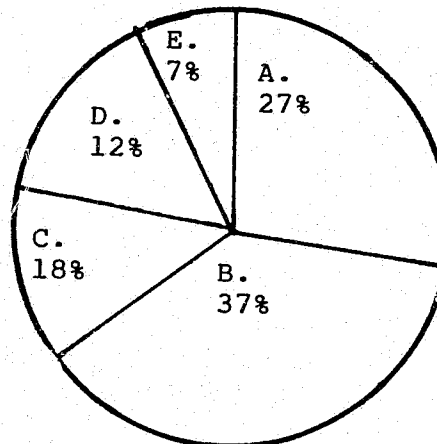

F No Significant %

1986

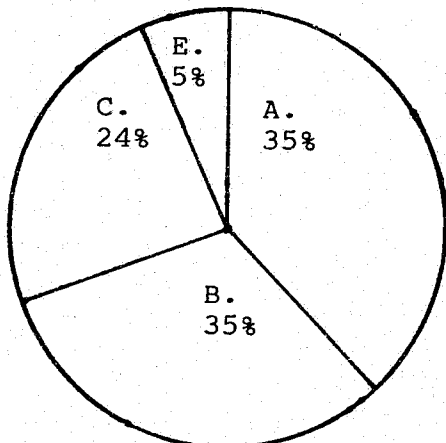

D & F No Significant %

1987

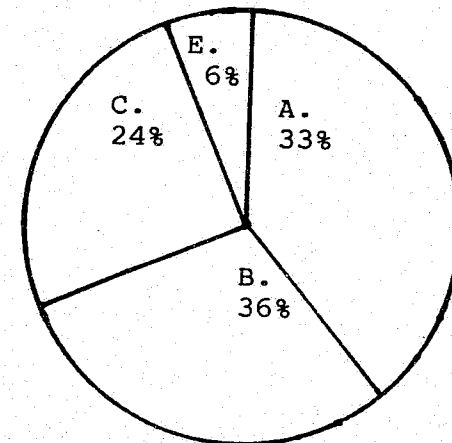

D & F No Significant %

KEY

- A. Incarceration (State)
- B. Incarceration (Local)
- C. Probation
- D. Conditional Discharge
- E. Restitution/Fine/Other
- F. Unccnditional Discharge

ALL ROBBERIES  
(SEE TABLE VI PG. 83 )

1984

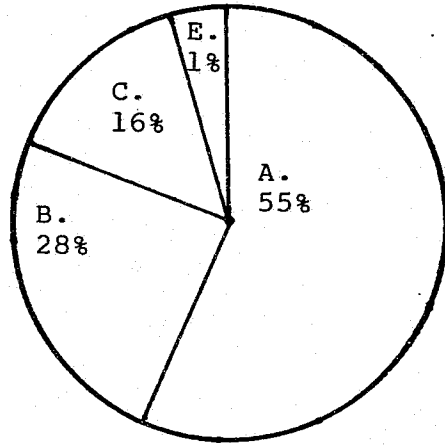

D & F No Significant %

1985

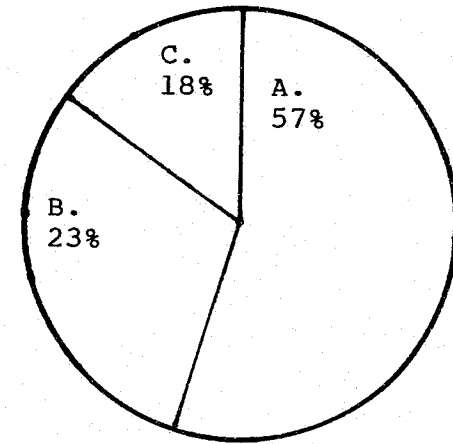

D, E & F No Significant %

1988

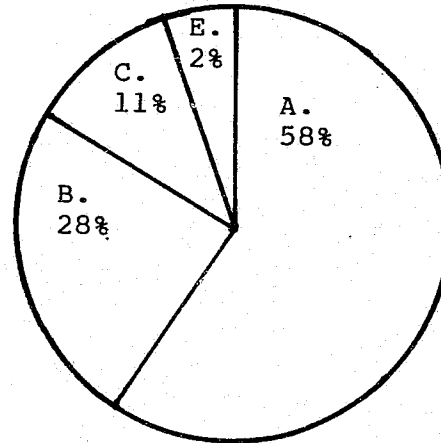

D & F No Significant %

1986

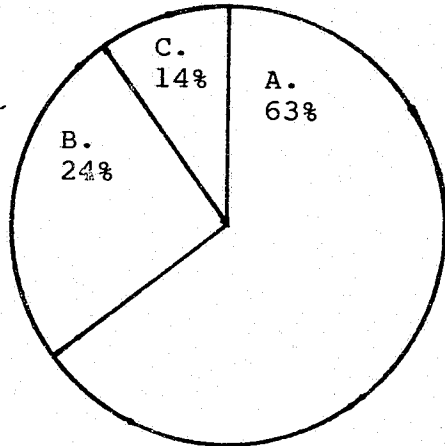

D, E, F No Significant %

1987

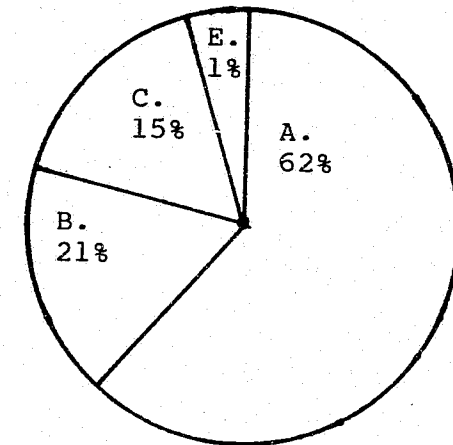

D & F No Significant %

KEY

- A. Incarceration (State)
- B. Incarceration (Local)
- C. Probation
- D. Conditional Discharge
- E. Restitution/Fine/Other
- F. Unconditional Discharge

GRAPH FOUR - SENTENCES ON CONVICTION ON INDICTMENTS AND SUPERIOR COURT INFORMATION - COUNTY COURT

ALL BURGLARIES  
(SEE TABLE VI, PG.84 )

1984

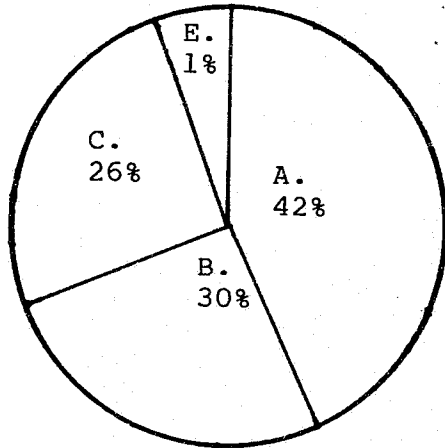

D, F No Significant %

1985

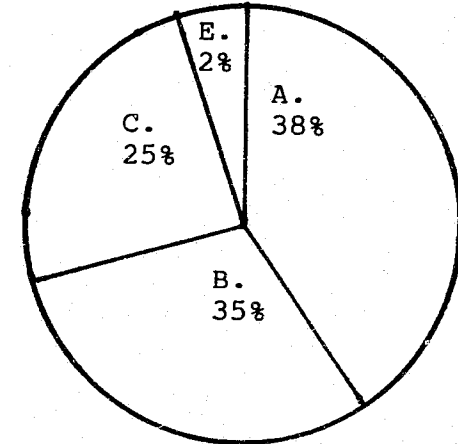

D, F, No Significant %

1988

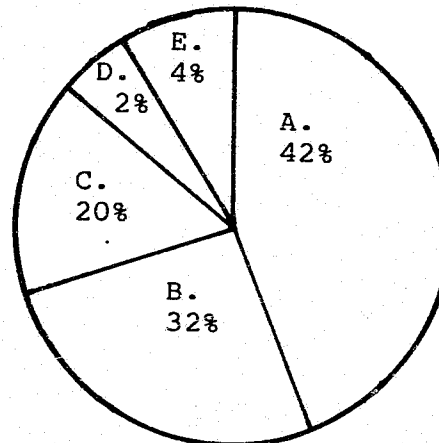

F, No Significant %

1986

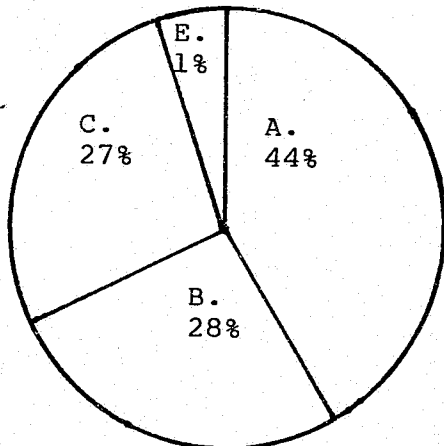

D, F, No Significant %

1987

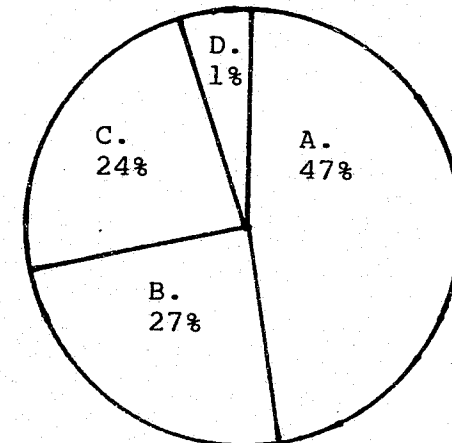

E, F, No Significant %

KEY

- A. Incarceration (State)
- B. Incarceration (Local)
- C. Probation
- D. Conditional Discharge
- E. Restitution/Fine/Other
- F. Unconditional Discharge

ALL NARCOTIC CASES  
(SEE TABLE VI, PG. 86 )

1986

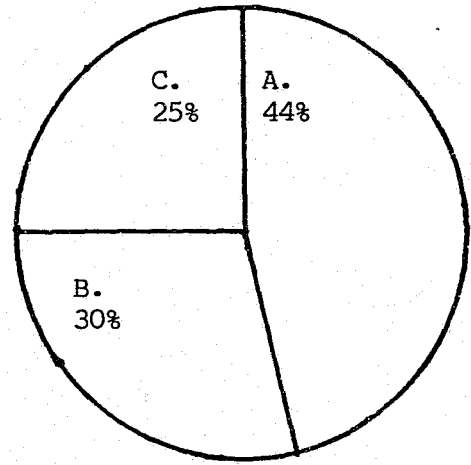

D, E & F No Significant %

1987

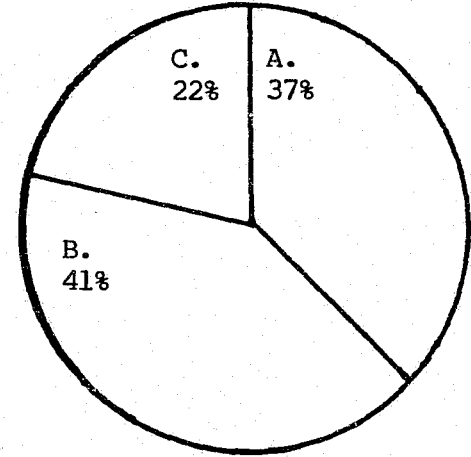

D, E & F No Significant %

1988

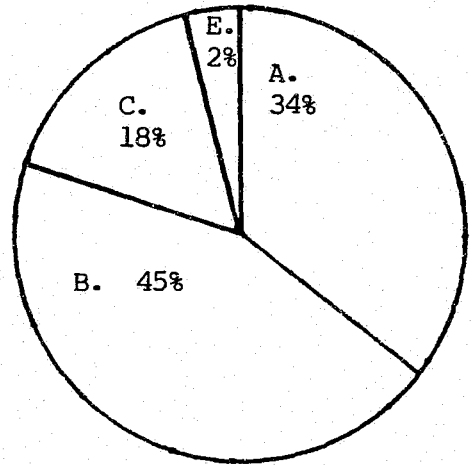

D & F No Significant %

- KEY
- A. Incarceration (State)
  - B. Incarceration (Local)
  - C. Probation
  - D. Conditional Discharge
  - E. Restitution/Fine/Other
  - F. Unconditional Discharge

TABLE VII

CASE PROCESSING TIME - COUNTY COURT

Table VII describes the mean time it takes to process a felony case in County Court. Time periods when the case is classified as inactive (such as during the pendency of a warrant) are not included.

A. Mean Days Arrest to Disposition (Inc. Plea & Trial)

	<u>1984</u>		<u>1985</u>		<u>1984-1985</u>	
					<u>%Change</u>	
All Felonies	233		219		- 6%	
Robbery	227		211		- 7%	
Burglary	272		191		- 30%	
	<u>1986</u>	<u>1984-1986</u>	<u>1987</u>	<u>1984-1987</u>	<u>1988</u>	<u>1984-1988</u>
		<u>%Change</u>		<u>%Change</u>		<u>%Change</u>
All Felonies	212	- 9%	220	- 6%	222	- 5%
Robbery	220	- 3%	218	- 4%	205	- 10%
Burglary	201	- 26%	212	- 22%	189	- 31%
Narcotics	222	-	218	-	257	-

B. Mean Days Arrest to Plea/Verdict (Excluding Time to Sentence)

	<u>1984</u>		<u>1985</u>		<u>1984-1985</u>	
					<u>%Change</u>	
All Felonies	168		162		- 4%	
Robbery	159		152		- 4%	
Burglary	210		128		- 39%	
	<u>1986</u>	<u>1984-1986</u>	<u>1987</u>	<u>1984-1987</u>	<u>1988</u>	<u>1984-1988</u>
		<u>%Change</u>		<u>%Change</u>		<u>%Change</u>
All Felonies	163	- 3%	167	N/A	162	- 4%
Robbery	176	11%	172	8%	161	1%
Burglary	153	- 27%	154	-27%	139	- 34%
Narcotics	177	-	166	-	176	-

C. Mean Days to Plea (Excluding Trial Time & Time to Sentence)

	<u>1984</u>		<u>1985</u>		<u>1984-1985</u>	
					<u>%Change</u>	
All Felonies	159		151		- 5%	
Robbery	146		151		3%	
Burglary	204		121		- 41%	
	<u>1986</u>	<u>1984-1986</u>	<u>1987</u>	<u>1984-1987</u>	<u>1988</u>	<u>1984-1988</u>
		<u>%Change</u>		<u>%Change</u>		<u>%Change</u>
All Felonies	155	- 3%	155	- 3%	153	- 4%
Robbery	155	6%	160	10%	149	2%
Burglary	149	- 27%	148	- 27%	130	- 36%
Narcotics	172	-	160	-	173	-

## SECTION II

### DISTRICT COURT ACTIVITY PERTAINING TO DISPOSITION OF FELONIES

In the development of a Criminal Justice Management Information System, of which this report may be considered a part, the key elements are: 1) the number of reported criminal incidents, 2) the number of arrests resulting from those incidents, 3) the number of cases prosecuted as a result of arrests and 4) the number and type of convictions and sentences resulting from the cases that are prosecuted. A shortcoming of the previous case processing reports was that the number of dispositions appeared to be far lower than the number of felony cases filed. This was due to the fact that the cases which were filed as felonies and disposed of as misdemeanors in District Court were not included. Thus, in the interest of presenting a more definitive picture of the actual workings of the prosecutorial and court components of the system, we are including a description of the felony cases that were disposed of in District Court as non-felonies.



TYPES OF DISPOSITIONS  
FELONIES - DISTRICT COURT

TABLE VIII

	<u>1984</u>	<u>Total Cases %1984</u>	<u>1985</u>	<u>Total Cases %1985</u>	<u>Total Cases 1984-1985 %Change</u>
A. Convictions By Plea	2,131	86%	2,221	88%	4 %
B. Convictions After Trial	23	N/A	16	N/A	-30.4%
C. Acquittal	18	N/A	12	N/A	-33.3%
D. D.I.S.	76	3%	60	2%	-21 %
E. Dismissals	218	9%	199	8%	- 8.7%
F. Transfer to Other Courts	<u>9</u>	N/A	<u>9</u>	N/A	N/A
TOTAL	2,475		2,517		

	<u>1986</u>	<u>Total Cases %1986</u>	<u>Total Cases 1984-1986 %Change</u>	<u>1987</u>	<u>Total Cases %1987</u>	<u>Total Cases 1984-1987 %Change</u>	<u>1988</u>	<u>Total Cases %1988</u>	<u>Total Cases 1984-1988 %Change</u>
A. Convictions By Plea	2,419	86%	13.5%	2,290	87%	7.4%	2,553	89%	19.8%
B. Convictions After Trial	24	N/A	4.3%	10	N/A	- 57 %	10	N/A	- 56.5%
C. Acquittal	19	N/A	5.6%	15	N/A	- 16.7%	11	N/A	- 38.9%
D. D.I.S.	73	3%	- 3.9%	63	2%	- 17.1%	65	2%	- 14.5%
E. Dismissals	279	10%	28 %	244	9%	11.9%	232	8%	6.4%
F. Transfer to Other Courts	<u>9</u>	N/A	N/A	<u>12</u>	N/A	N/A	<u>11</u>	N/A	22.2%
Total	2,823			2,634			2,882		

TYPES OF DISPOSITIONS  
ROBBERY, BURGLARY, NARCOTICS - DISTRICT COURT

TABLE IX

<u>ROBBERY</u>	<u>1984</u>	<u>Total Cases %1984</u>	<u>1985</u>	<u>Total Cases %1985</u>	<u>Total Cases 1984-1985 %Change</u>
A. Convictions By Plea	75	63%	76	67%	1.3%
B. Convictions After Trial	2	2%	0	N/A	-100 %
C. Acquittal	1	N/A	0	N/A	-100 %
D. D.I.S.	15	13%	17	15%	13.3%
E. Dismissals	23	19%	18	16%	- 22.7%
F. Transfer to Other Courts	<u>4</u>	3%	<u>2</u>	2%	- 50 %
TOTAL	120		113		

<u>ROBBERY</u>	<u>1986</u>	<u>Total Cases %1986</u>	<u>Total Cases 1984-1986 %Change</u>	<u>1987</u>	<u>Total Cases %1987</u>	<u>Total Cases 1984-1987 %Change</u>	<u>1988</u>	<u>Total Cases %1988</u>	<u>Total Cases 1984-1988 %Change</u>
A. Convictions By Plea	83	66%	10.7%	105	79%	40 %	115	74%	53.3%
B. Convictions After Trial	0	N/A	- 100 %	0	N/A	-100 %	0	N/A	-100 %
C. Acquittal	2	2%	100 %	0	N/A	-100 %	0	N/A	-100 %
D. D.I.S.	9	7%	- 40 %	5	4%	- 66.7%	5	3%	- 66.7%
E. Dismissals	27	22%	17.4%	20	15%	- 13 %	31	20%	34.8%
F. Transfer to Other Courts	<u>4</u>	3%	N/A	<u>3</u>	2%	- 25 %	<u>4</u>	3%	N/A
TOTAL	125			133			155		

TYPES OF DISPOSITIONS  
ROBBERY, BURGLARY, NARCOTICS - DISTRICT COURT

TABLE IX (Cont'd)

<u>BURGLARY</u>	<u>1984</u>	<u>Total Cases %1984</u>	<u>1985</u>	<u>Total Cases %1985</u>	<u>Total Cases 1984-1985 %Change</u>
A. Convictions By Plea	281	80%	285	88%	1.4%
B. Convictions After Trial	1	N/A	2	N/A	100 %
C. Acquittal	1	N/A	0	N/A	-100 %
D. D.I.S.	17	5%	13	4%	- 23.5%
E. Dismissals	49	14%	24	7%	- 51 %
F. Transfer to Other Courts	<u>1</u>	N/A	<u>0</u>	N/A	-100 %
<b>TOTAL</b>	<b>350</b>		<b>324</b>		

<u>BURGLARY</u>	<u>1986</u>	<u>Total Cases %1986</u>	<u>Total Cases 1984-1986 %Change</u>	<u>1987</u>	<u>Total Cases %1987</u>	<u>Total Cases 1984-1987 %Change</u>	<u>1988</u>	<u>Total Cases %1988</u>	<u>Total Cases 1984-1988 %Change</u>
A. Convictions By Plea	257	86%	- 29.6%	299	86%	6.4%	299	87%	6.4%
B. Convictions After Trial	4	1%	300 %	1	N/A	N/A	0	N/A	-100 %
C. Acquittal	0	N/A	100 %	1	N/A	N/A	0	N/A	-100 %
D. D.I.S.	12	4%	- 29.4%	16	5%	- 5.9%	12	4%	- 1.7%
E. Dismissals	27	9%	- 44.9%	31	9%	- 36.7%	29	8%	- 40.8%
F. Transfer to Other Courts	<u>0</u>	N/A	-100 %	<u>1</u>	N/A	N/A	<u>2</u>	N/A	100 %
<b>TOTAL</b>	<b>300</b>			<b>349</b>			<b>342</b>		

TYPES OF DISPOSITIONS  
ROBBERY, BURGLARY, NARCOTICS - DISTRICT COURT

TABLE IX (Cont'd)

<u>NARCOTICS</u>	<u>1986</u>	<u>Total Cases %1986</u>	<u>1987</u>	<u>Total Cases %1987</u>	<u>Total Cases 1986-1987 %Change</u>
A. Convictions By Plea	126	83%	128	66%	1.2%
B. Convictions After Trial	0	N/A	3	2%	100 %
C. Acquittal	0	N/A	1	N/A	100 %
D. D.I.S.	1	N/A	12	6%	1,100 %
E. Dismissals	26	17%	50	26%	92.3%
F. Transfer to Other Courts	<u>0</u>	N/A	<u>0</u>	N/A	N/A
TOTAL	152		194		

<u>NARCOTICS</u>	<u>1988</u>	<u>Total Cases %1988</u>	<u>Total Cases 1986-1988 %Change</u>
A. Convictions By Plea	189	87%	50 %
B. Convictions After Trial	2	N/A	100 %
C. Acquittal	0	N/A	N/A
D. D.I.S.	11	5%	1,000 %
E. Dismissals	16	7%	- 38.5%
F. Transfer to Other Courts	<u>0</u>	N/A	N/A
TOTAL	218		

TYPES OF SENTENCES

FELONIES - DISTRICT COURT

TABLE X

	<u>1984</u>	<u>Total Cases %1984</u>	<u>1985</u>	<u>Total Cases %1985</u>	<u>Total Cases 1984-1985 %Change</u>
A. Incarceration (Local)	572	27%	615	28%	7.5%
B. Probation	741	35%	728	33%	- 1.8%
C. Conditional Discharge	208	10%	230	11%	10.6%
D. Restitution Fine/Other	556	27%	602	28%	8.3%
E. Unconditional Discharge	<u>12</u>	N/A	<u>8</u>	N/A	-33.3%
TOTAL	2,089		2,183		

	<u>1986</u>	<u>Total Cases %1986</u>	<u>Total Cases 1984-1986 %Change</u>	<u>1987</u>	<u>Total Cases %1987</u>	<u>Total Cases 1984-1987 %Change</u>	<u>1988</u>	<u>Total Cases %1988</u>	<u>Total Cases 1984-1988 %Change</u>
A. Incarceration (Local)	689	32%	20.5%	666	34%	16.4%	774	31%	35.3%
B. Probation	772	35%	4.2%	706	36%	- 4.7%	703	28%	- 5.1%
C. Conditional Discharge	245	11%	17.8%	132	7%	- 36.5%	190	8%	- 8.7%
D. Restitution Fine/Other	446	20%	- 19.8%	448	23%	- 19.4%	810	33%	45.7%
E. Unconditional Discharge	<u>27</u>	1%	125 %	<u>16</u>	N/A	33.3%	<u>12</u>	N/A	N/A
TOTAL	2,179			1,968			2,489		

TYPES OF SENTENCES  
ROBBERY - DISTRICT COURT

TABLE XI

	<u>1984</u>	<u>Total Cases %1984</u>	<u>1985</u>	<u>Total Cases %1985</u>	<u>Total Cases 1984-1985 %Change</u>
A. Incarceration (Local)	18	25%	30	40%	66.7%
B. Probation	22	31%	17	23%	- 22.7%
C. Conditional Discharge	5	7%	12	16%	140 %
D. Restitution Fine/Other	26	37%	16	21%	- 38.5%
E. Unconditional Discharge	<u>0</u>	N/A	<u>0</u>	N/A	N/A
TOTAL	71		75		

<u>ROBBERY</u>	<u>1986</u>	<u>Total Cases %1986</u>	<u>Total Cases 1984-1986 %Change</u>	<u>1987</u>	<u>Total Cases %1987</u>	<u>Total Cases 1984-1987 %Change</u>	<u>1988</u>	<u>Total Cases %1988</u>	<u>Total Cases 1984-1988 %Change</u>
A. Incarceration (Local)	32	43%	77.8%	43	48%	138.9%	50	45%	177.8%
B. Probation	25	34%	13.6%	33	37%	50 %	23	21%	4.5%
C. Conditional Discharge	11	15%	120 %	3	3%	- 40 %	10	9%	100 %
D. Restitution Fine/Other	6	8%	- 76.9%	10	11%	- 61.5%	1	N/A	- 96.2%
E. Unconditional Discharge	<u>0</u>	N/A	N/A	<u>1</u>	1%	100 %	<u>28</u>	25%	100 %
TOTAL	74			90			112		

TYPES OF SENTENCES

BURGLARY - DISTRICT COURT

TABLE XI Cont'd)

<u>BURGLARY</u>	<u>1984</u>	<u>Total Cases %1984</u>	<u>1985</u>	<u>Total Cases %1985</u>	<u>Total Cases 1984-1985 %Change</u>
A. Incarceration (Local)	77	29%	88	31%	14.3%
B. Probation	110	41%	92	33%	- 16.4%
C. Conditional Discharge	26	10%	30	11%	15.4%
D. Restitution Fine/Other	51	19%	70	25%	37.3%
E. Unconditional Discharge	<u>5</u>	2%	<u>2</u>	N/A	- 60 %
TOTAL	269		282		

<u>BURGLARY</u>	<u>1986</u>	<u>Total Cases %1986</u>	<u>Total Cases 1984-1986 %Change</u>	<u>1987</u>	<u>Total Cases %1987</u>	<u>Total Cases 1984-1987 %Change</u>	<u>1988</u>	<u>Total Cases %1988</u>	<u>Total Cases 1984-1988 %Change</u>
A. Incarceration (Local)	74	31%	- 3.9%	105	39%	36.4%	99	36%	28.6%
B. Probation	97	40%	- 11.8%	92	34%	- 16.4%	74	27%	- 32.7%
C. Conditional Discharge	28	12%	7.7%	22	8%	- 15.4%	24	9%	- 8.3%
D. Restitution Fine/Other	36	15%	- 29.4%	48	18%	- 5.9%	78	28%	52.9%
E. Unconditional Discharge	<u>5</u>	2%	N/A	<u>3</u>	1%	- 40 %	<u>1</u>	N/A	- 80 %
TOTAL	240			270			276		

TYPES OF SENTENCES  
NARCOTIC CASES - DISTRICT COURT

TABLE XI (Cont'd)

<u>NARCOTICS</u>	<u>1986</u>	<u>Total Cases %1986</u>	<u>1987</u>	<u>Total Cases %1987</u>	<u>Total Cases 1986-1987 %Change</u>
A. Incarceration (Local)	38	34%	47	41%	23.7%
B. Probation	49	43%	49	43%	N/A
C. Conditional Discharge	11	10%	4	3%	- 63.6%
D. Restitution Fine/Other	15	13%	14	12%	- 6.7%
E. Unconditional Discharge	<u>0</u>	N/A	<u>1</u>	N/A	100 %
TOTAL	113		115		

<u>NARCOTICS</u>	<u>1988</u>	<u>Total Case %1988</u>	<u>Total Cases 1986-1988 %Change</u>
A. Incarceration (Local)	85	45%	123.7%
B. Probation	52	27%	6.1%
C. Conditional Discharge	5	3%	- 54.5%
D. Restitution Fine/Other	47	25%	213.3%
E. Unconditional Discharge	<u>2</u>	1%	100 %
TOTAL	191		



(SEE TABLE X, PG. 96)

1984

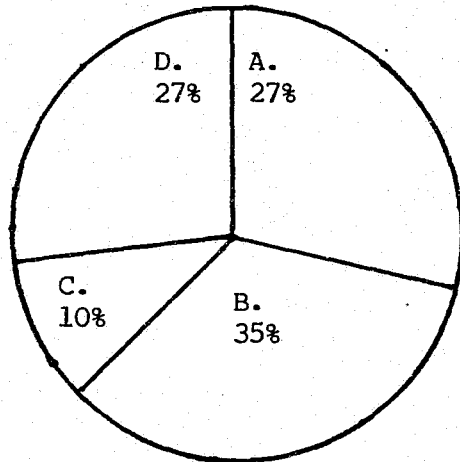

E, No Significant %

1985

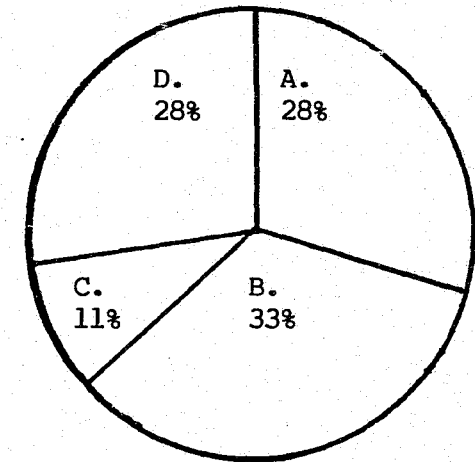

E, No Significant %

1988

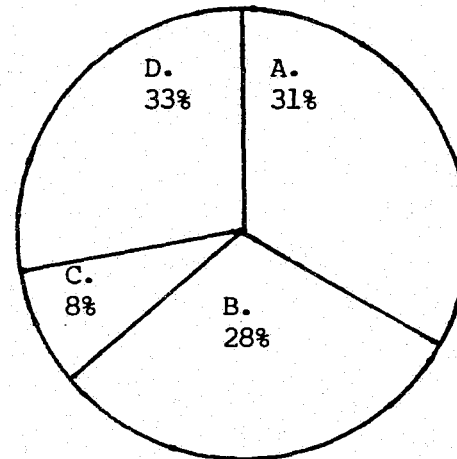

E, No Significant %

1986

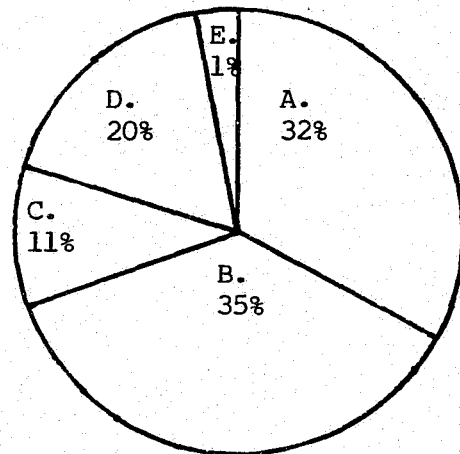

1987

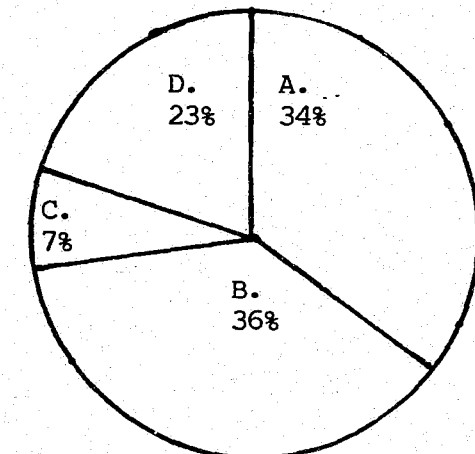

E, No Significant %

KEY

- A. Incarceration (Local)
- B. Probation
- C. Conditional Discharge
- D. Restitution/Fine/Other
- E. Unconditional Discharge

GRAPH SEVEN - SENTENCES FOR ROBBERIES DISPOSED OF IN DISTRICT COURT

(SEE TABLE XI, PG. 97 )

1984

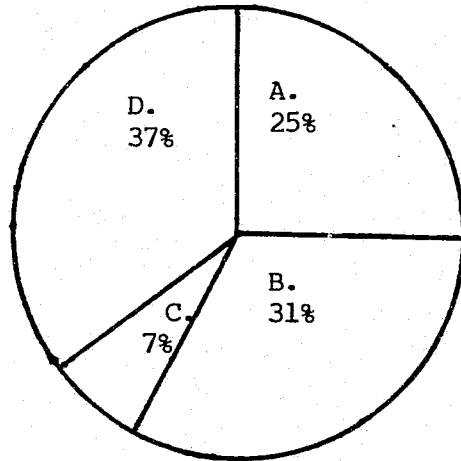

E, No Significant %

1985

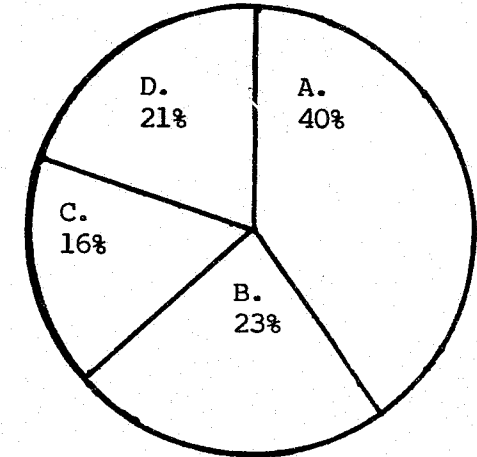

E, No Significant %

1988

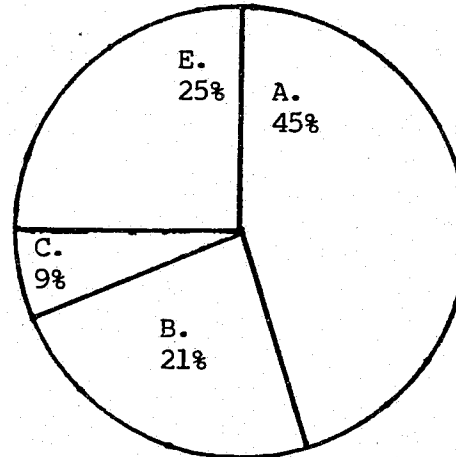

D, No Significant %

1986

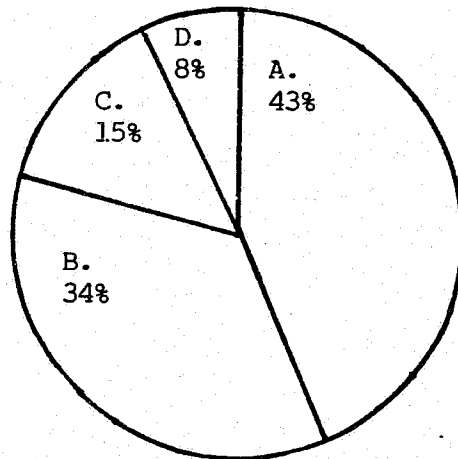

E, No Significant %

1987

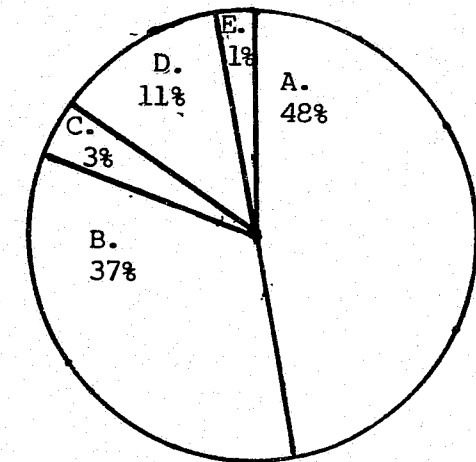

KEY

- A. Incarceration (Local)
- B. Probation
- C. Conditional Discharge
- D. Restitution/Fine/Other
- E. Unconditional Discharge

(SEE TABLE XI, PG. 98 )

1984

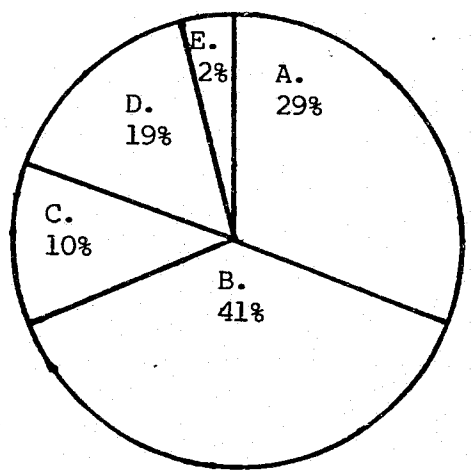

1985

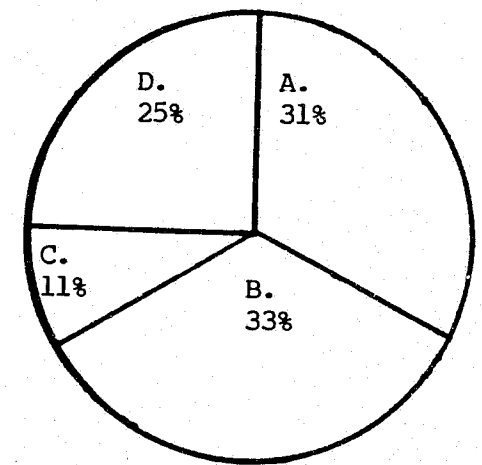

E, No Significant %

1988

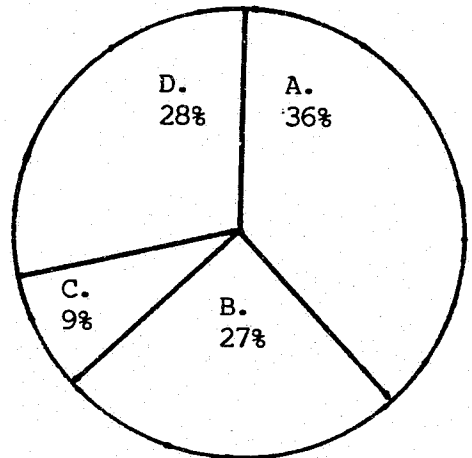

E, No Significant %

1986

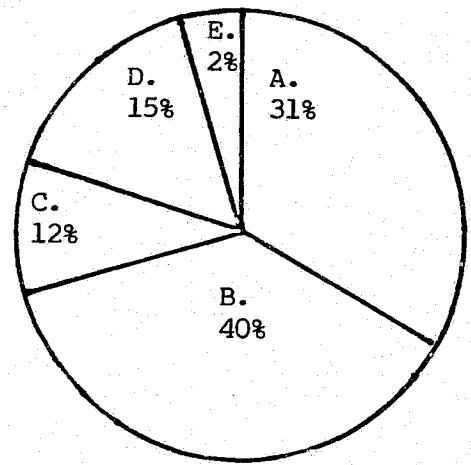

1987

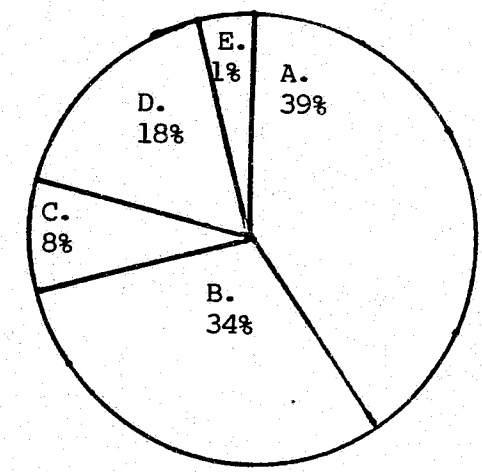

KEY

- A. Incarceration (Local)
- B. Probation
- C. Conditional Discharge
- D. Restitution/Fine/Other
- E. Unconditional Discharge

GRAPH NINE - SENTENCES FOR NARCOTIC CASES DISPOSED OF  
IN DISTRICT COURT

(SEE TABLE XI, PG. 99 )

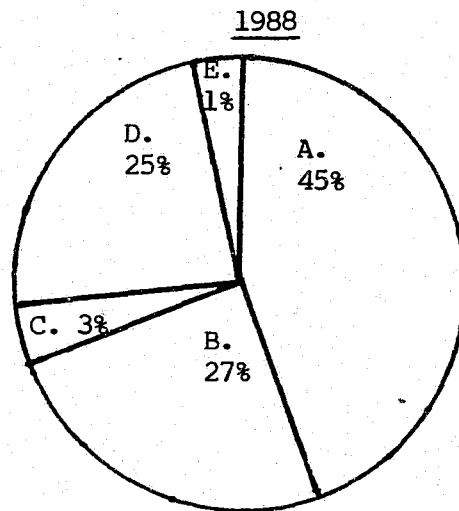
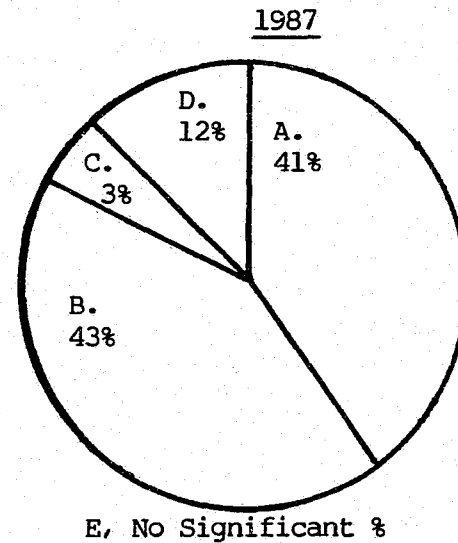
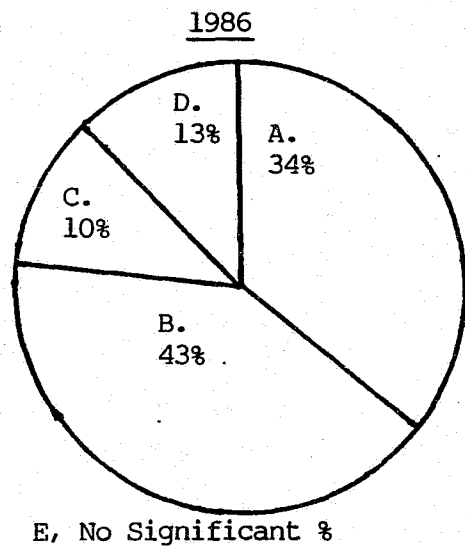

KEY

- A. Incarceration (Local)
- B. Probation
- C. Conditional Discharge
- D. Restitution/Fine/Other
- E. Unconditional Discharge

TABLE XII

CASE PROCESSING TIME - DISTRICT COURT

Table XII, below, describes the mean time it takes to process a felony case in District Court. Time periods when the case is classified as inactive (such as during the pendency of a warrant) are not included.

A. Mean Days Arrest to Disposition

	<u>1984</u>	<u>1985</u>	<u>1984-1985 %Change</u>
All Felonies	182	198	9%
Robbery	338	208	- 38%
Burglary	212	221	4%

	<u>1986</u>	<u>1984-1986 %Change</u>	<u>1987</u>	<u>1984-1987 %Change</u>	<u>1988</u>	<u>1984-1988 %Change</u>
All Felonies	168	- 8%	154	- 15%	149	- 18%
Robbery	156	- 54%	172	- 49%	150	- 56%
Burglary	160	- 25%	142	- 33%	139	- 34%
Narcotics	240	-	193	-	156	-

B. Mean Days Arrest to Plea/Verdict (Excluding Time to Sentence)

	<u>1984</u>	<u>1985</u>	<u>1984-1985 %Change</u>
All Felonies	106	114	8%
Robbery	323	141	- 56%
Burglary	101	113	12%

TABLE XII (Cont'd)

CASE PROCESSING TIME - DISTRICT COURT

B. Mean Days Arrest to Plea/Verdict (Excluding Time to Sentence) Cont'd)

	<u>1986</u>	<u>1984-1986</u> <u>%Change</u>	<u>1987</u>	<u>1984-1987</u> <u>%Change</u>	<u>1988</u>	<u>1984-1988</u> <u>%Change</u>
All Felonies	116	9%	107	N/A	104	- 2%
Robbery	105	- 67%	107	- 67%	115	- 64%
Burglary	112	11%	98	- 3%	91	- 10%
Narcotics	207	-	152	-	125	-

C. Mean Days Arrest to Plea (Excluding Trial Time & Time to Sentence)

	<u>1984</u>	<u>1985</u>	<u>1984-1985</u> <u>%Change</u>
All Felonies	107	112	5%
Robbery	321	140	- 56%
Burglary	101	112	11%

	<u>1986</u>	<u>1984-1986</u> <u>%Change</u>	<u>1987</u>	<u>1984-1987</u> <u>%Change</u>	<u>1988</u>	<u>1984-1988</u> <u>%Change</u>
All Felonies	115	7%	107	N/A	105	- 2%
Robbery	114	- 64%	110	- 66%	118	- 63%
Burglary	108	7%	96	- 5%	92	- 9%
Narcotics	215	-	159	-	125	-

### SECTION III

#### ANALYSIS OF HIGH CHARGE AT ARREST VS CHARGE AT CONVICTION

Some of the factors that impact on the analysis of pleas of guilty are: 1) the possible over-charging of a defendant; 2) the reactivation of cases from long-outstanding indictment warrants when a defendant is finally apprehended; 3) the legal problems in proving certain cases; and 4) the reduction of charges in exchange for a defendant's guilty plea, consistent with normal District Attorney's office policies.

Table XIII shows a comparison between the initial highest charge at arrest and the charge at point of conviction whether by guilty verdict after trial or by plea of guilty.

Charge reductions shown in the guilty verdict after trial columns, in Table XIII on page and , are not the result of plea negotiations, but rather are a result of the trial process.

COUNTY COURT FELONY CONVICTIONS 1984-1988

TABLE XIII

GUILTY VERDICT AFTER TRIAL

<u>HIGH CHARGE AT ARREST</u>	<u>High Felony Charge</u>		<u>Other Lesser Felony</u>		<u>Non Felony</u>		<u>TOTALS</u>
<u>1984</u>							
All Felonies	96	66%	32	22%	17	12%	145
Robbery	22	63%	10	29%	3	9%	35
Burglary	29	81%	3	8%	4	11%	36
<u>1985</u>							
All Felonies	116	74%	31	20%	10	6%	157
Robbery	29	85%	5	15%	0	N/A	34
Burglary	19	90%	1	5%	1	5%	21
<u>1986</u>							
All Felonies	113	74%	29	19%	11	7%	153
Robbery	32	71%	10	22%	3	7%	45
Burglary	13	72%	4	22%	1	6%	18
Narcotics	18	90%	1	5%	1	5%	20
<u>1987</u>							
All Felonies	93	65%	28	20%	21	15%	142
Robbery	14	70%	4	20%	2	10%	20
Burglary	16	80%	1	5%	3	15%	20
Narcotics	12	48%	8	32%	5	20%	25
<u>1988</u>							
All Felonies	76	63%	21	17%	24	20%	121
Robbery	13	68%	3	16%	3	16%	19
Burglary	12	63%	1	5%	6	32%	19
Narcotics	15	68%	3	14%	4	18%	22



COUNTY COURT FELONY CONVICTIONS 1984-1988

TABLE XIII (Cont'd)

PLEA OF GUILTY

<u>HIGH CHARGE AT ARREST</u>	<u>High Felony Charge</u>		<u>Other Lesser Felony</u>		<u>Non Felony</u>		<u>TOTALS</u>
<u>1984</u>							
All Felonies	630	32%	939	48%	398	20%	1,967
Robbery	116	32%	227	63%	16	4%	359
Burglary	177	38%	221	48%	63	14%	461
<u>1985</u>							
All Felonies	622	32%	921	47%	420	21%	1,963
Robbery	68	29%	160	69%	5	2%	233
Burglary	155	35%	232	52%	56	13%	443
<u>1986</u>							
All Felonies	756	33%	1,010	45%	491	22%	2,257
Robbery	91	31%	188	64%	15	5%	294
Burglary	158	35%	234	53%	49	11%	441
Narcotics	32	10%	273	85%	16	5%	321
<u>1987</u>							
All Felonies	580	26%	1,168	53%	472	21%	2,220
Robbery	61	23%	185	69%	21	8%	267
Burglary	103	28%	218	60%	41	11%	362
Narcotics	42	7%	494	87%	29	5%	565
<u>1988</u>							
All Felonies	607	22%	1,563	57%	594	21%	2,764
Robbery	59	22%	185	68%	27	10%	271
Burglary	96	28%	189	54%	64	18%	349
Narcotics	65	7%	849	89%	38	4%	952